

Scene	Duration	Panel	Duration
004	02:14	001	02:14

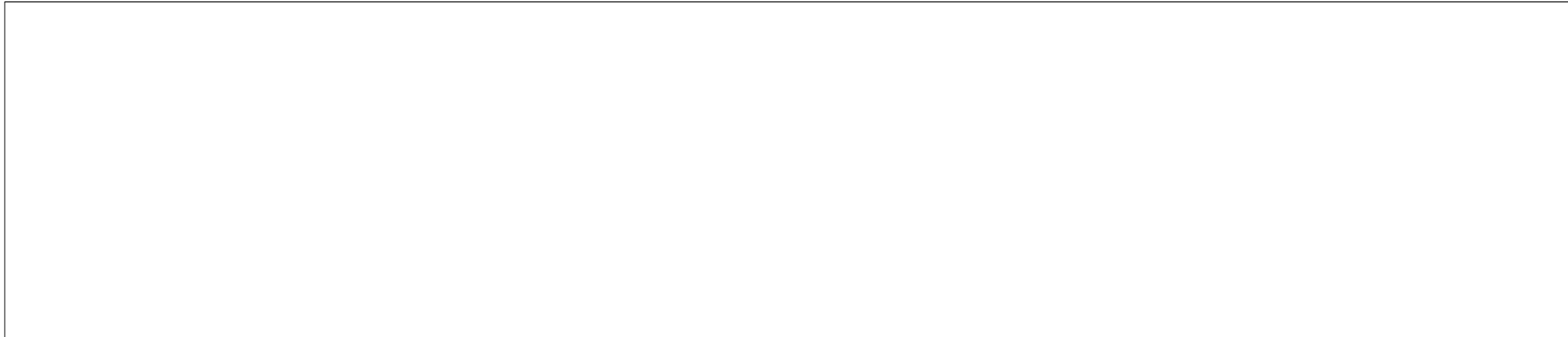

Scene	Duration	Panel	Duration
004	02:14	001	02:14

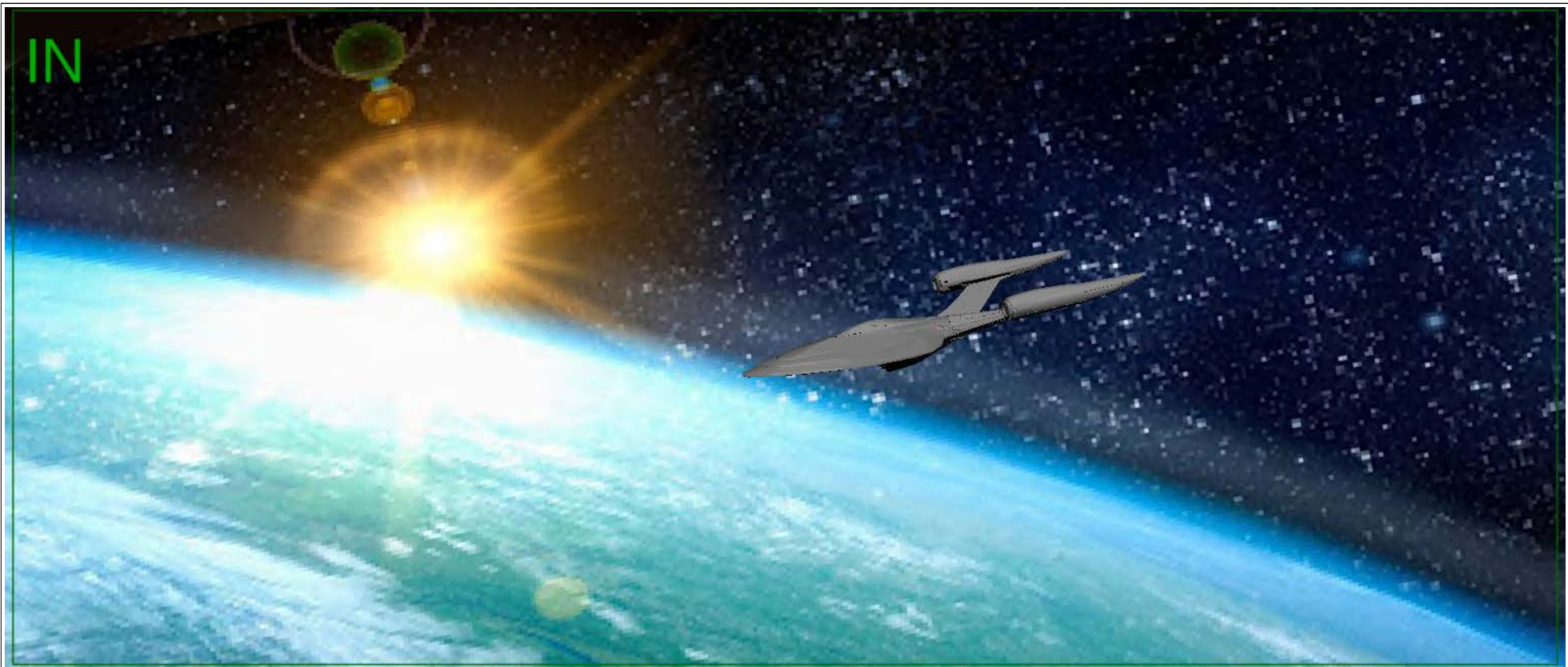
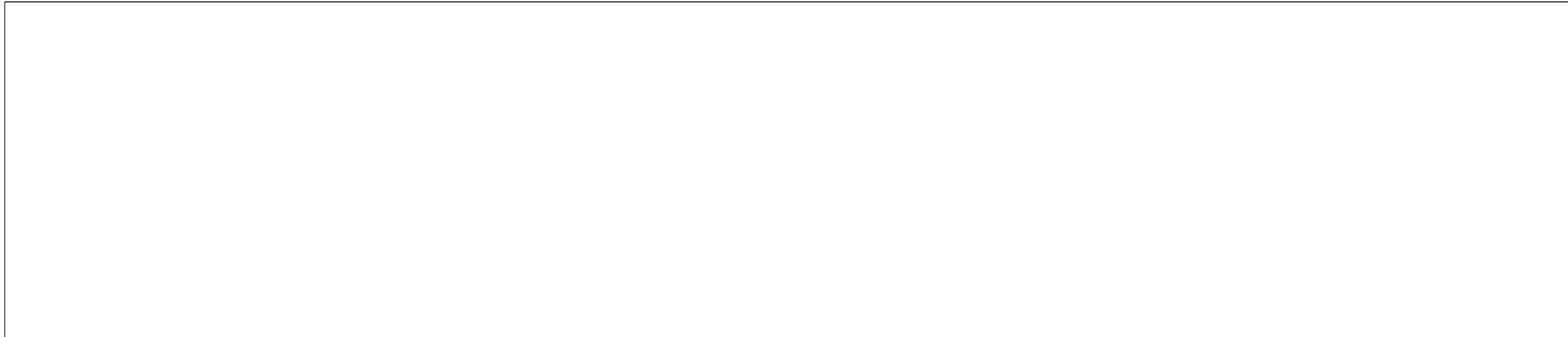
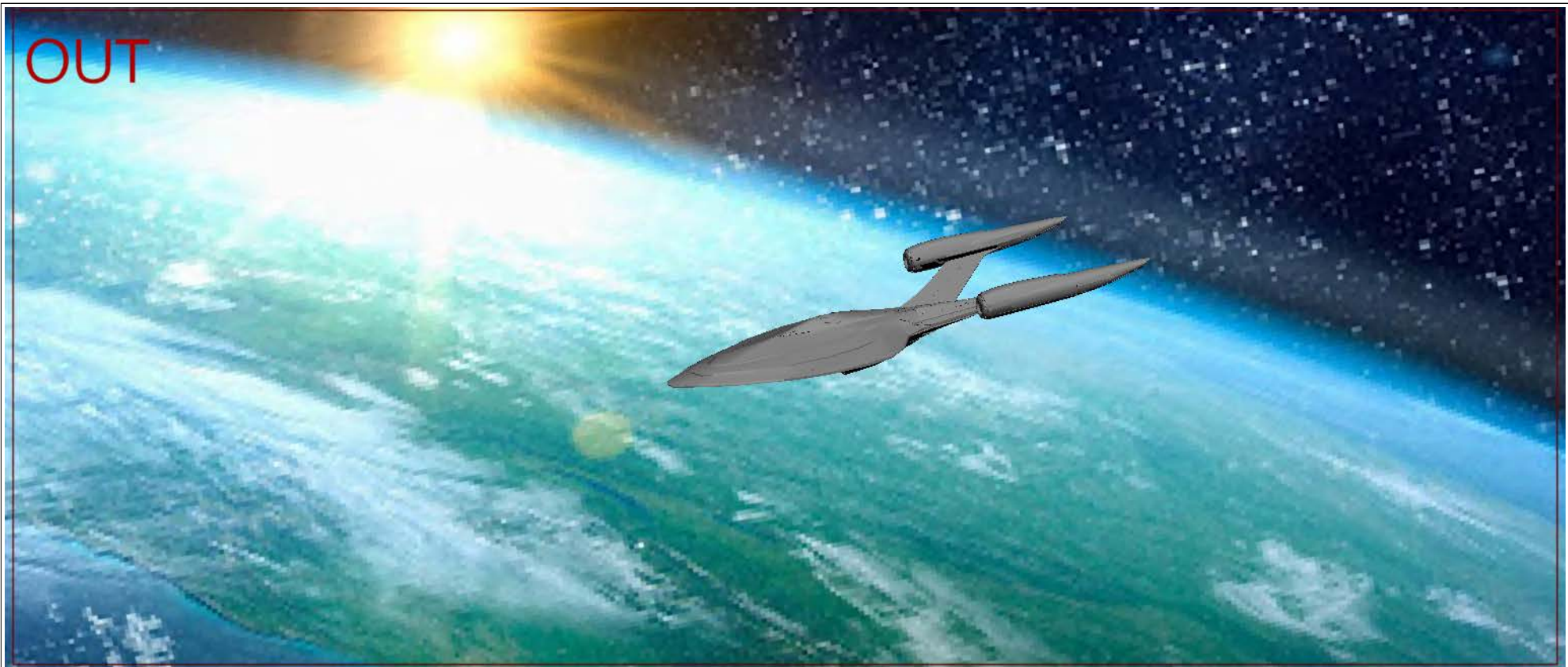

Scene	Duration	Panel	Duration
006	04:19	001	04:19

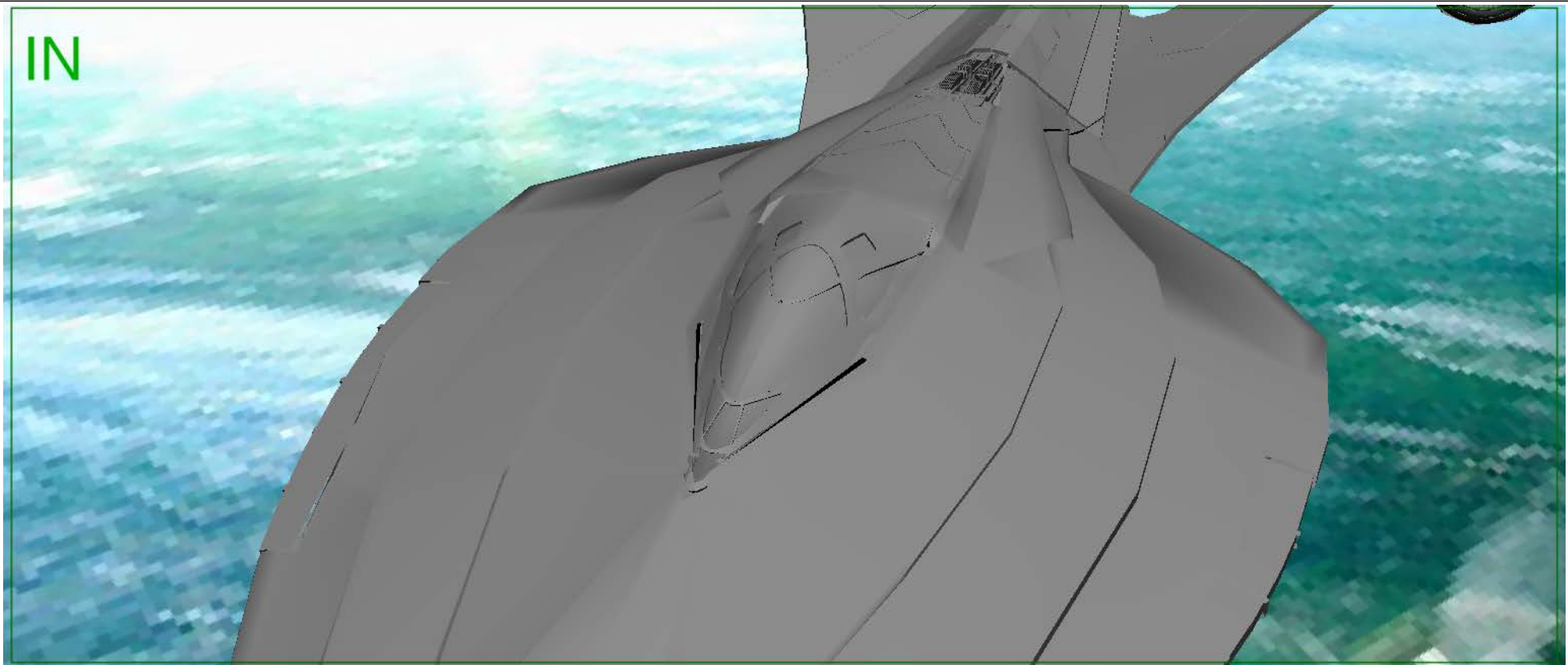

Scene	Duration	Panel	Duration
006	04:19	001	04:19

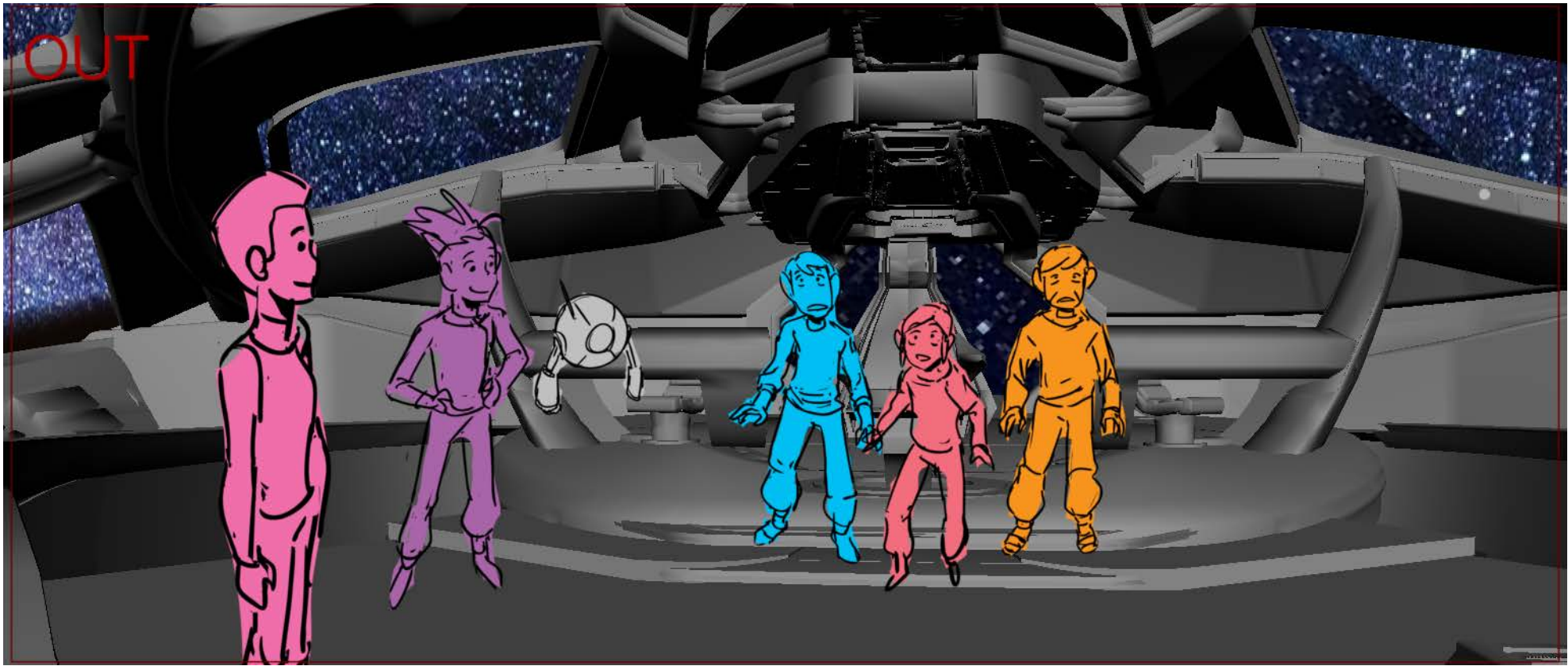

Scene	Duration	Panel	Duration
007	04:13	001	00:15

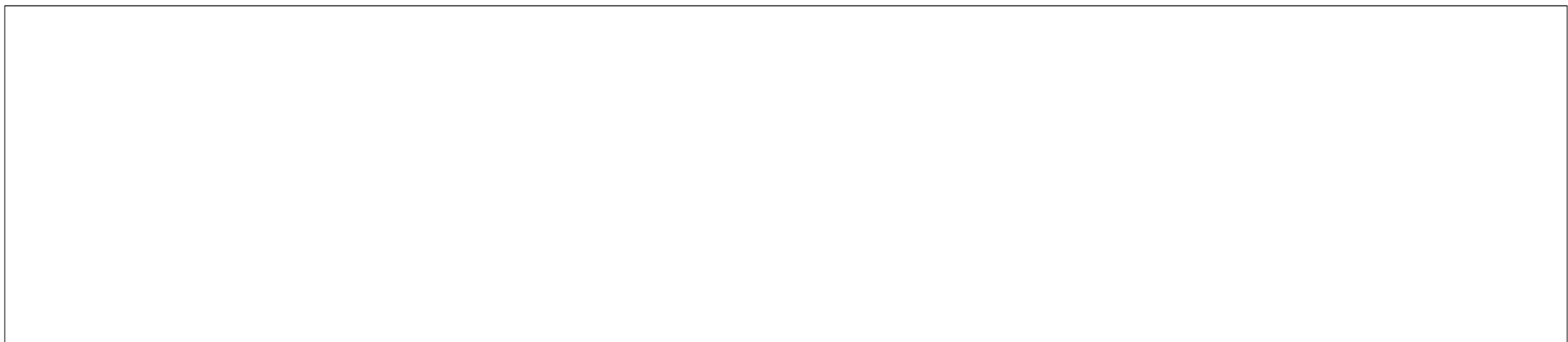

Scene	Duration	Panel	Duration
007	04:13	001A0	00:09



Scene	Duration	Panel	Duration
007	04:13	001A	00:12

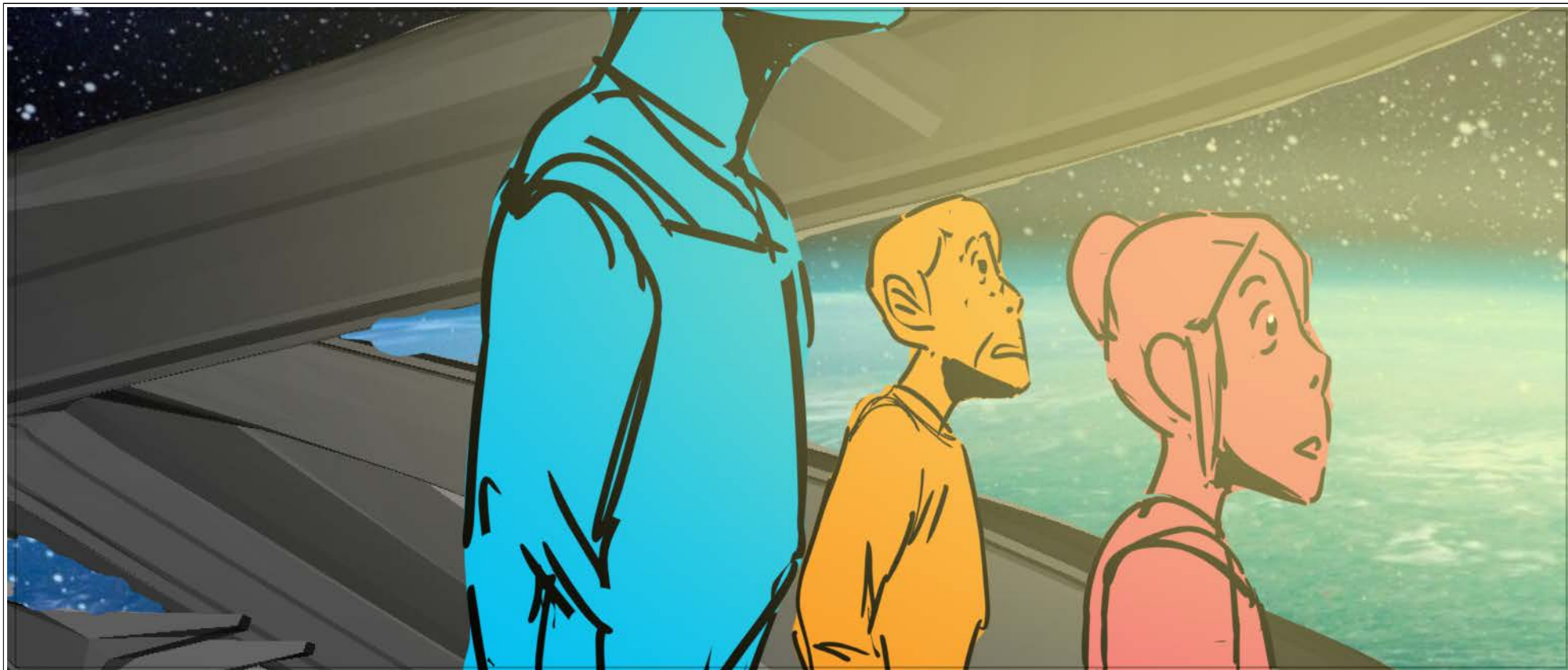

Action Notes
CAMERA ORBITS

Scene	Duration	Panel	Duration
007	04:13	001A_1	00:13

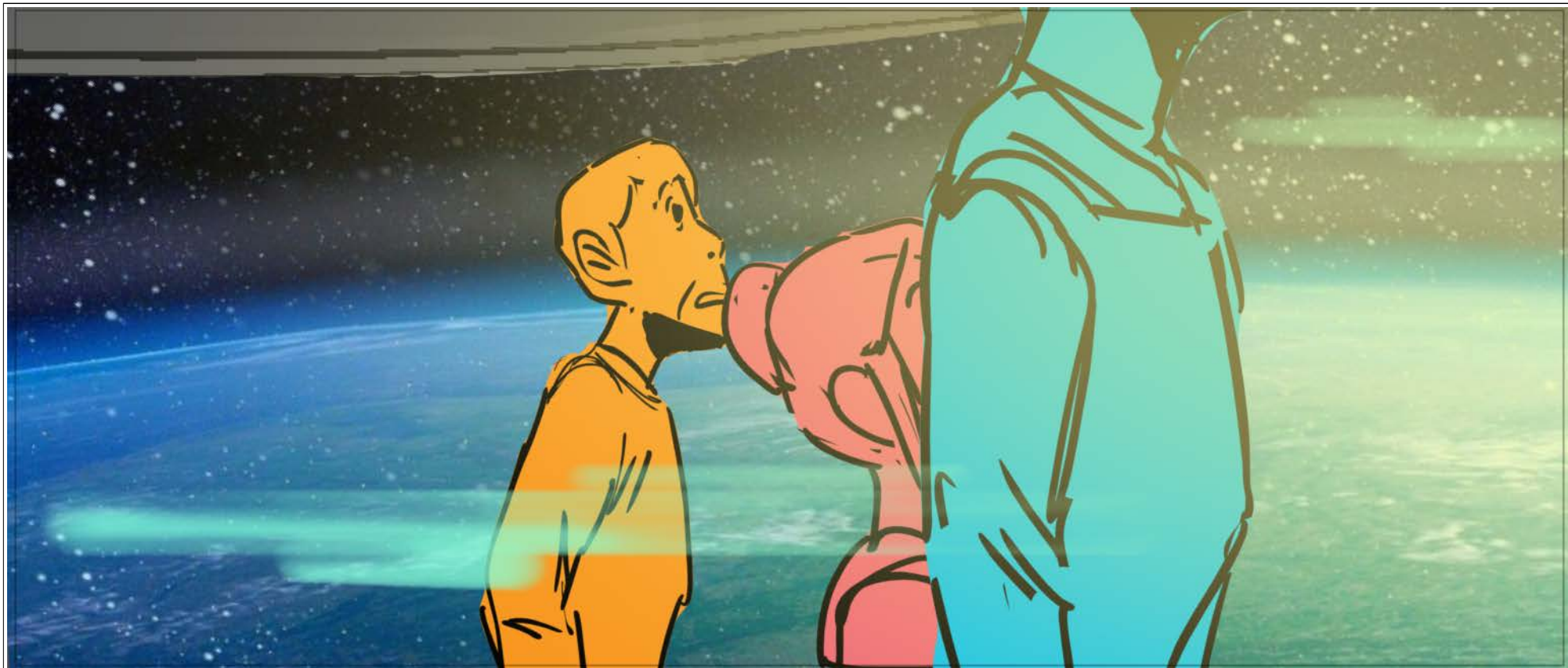

Action Notes
CAMERA ORBITS

Scene	Duration	Panel	Duration
007	04:13	001B	00:10



Scene	Duration	Panel	Duration
007	04:13	001D	00:14

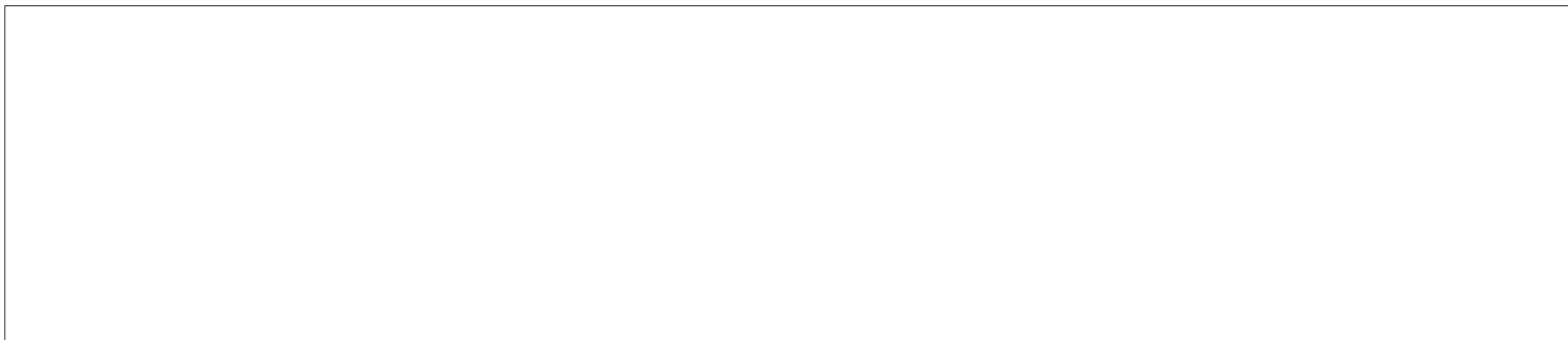
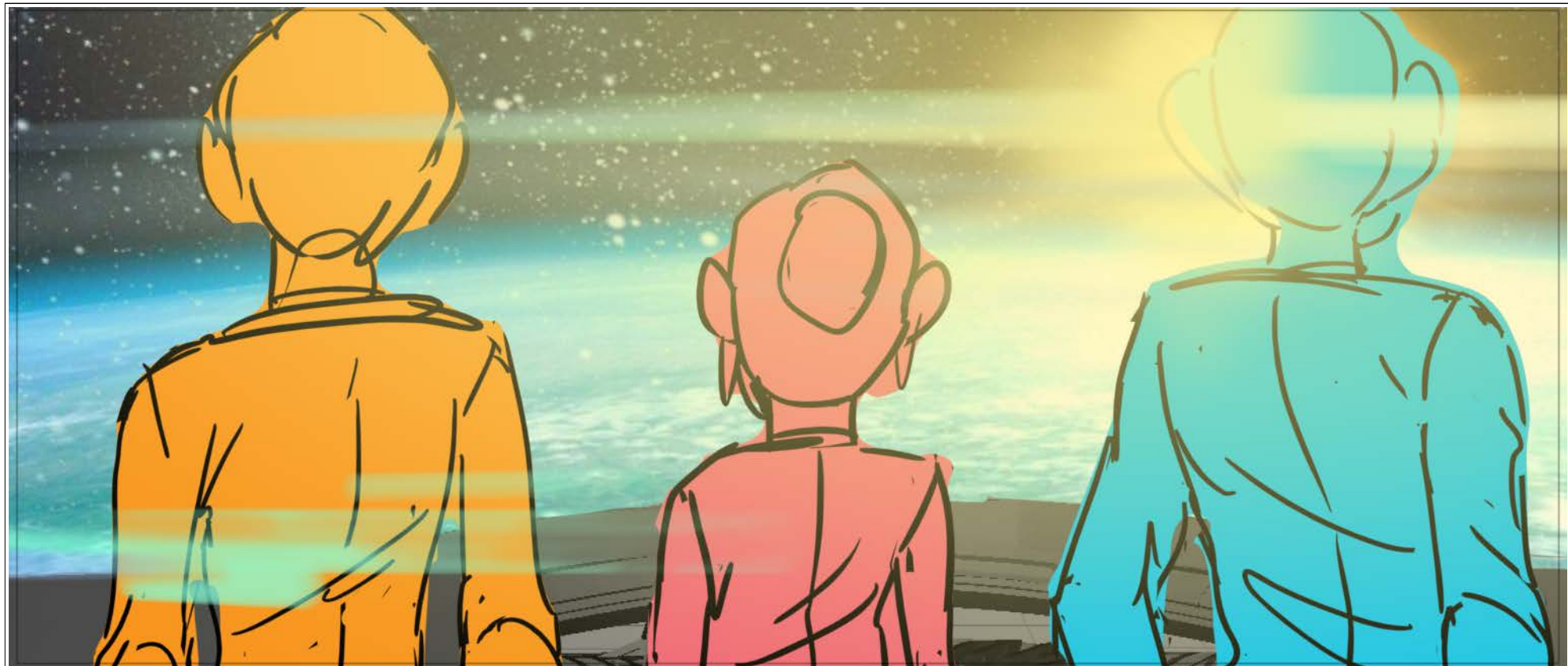

Scene	Duration	Panel	Duration
007	04:13	001C	00:12

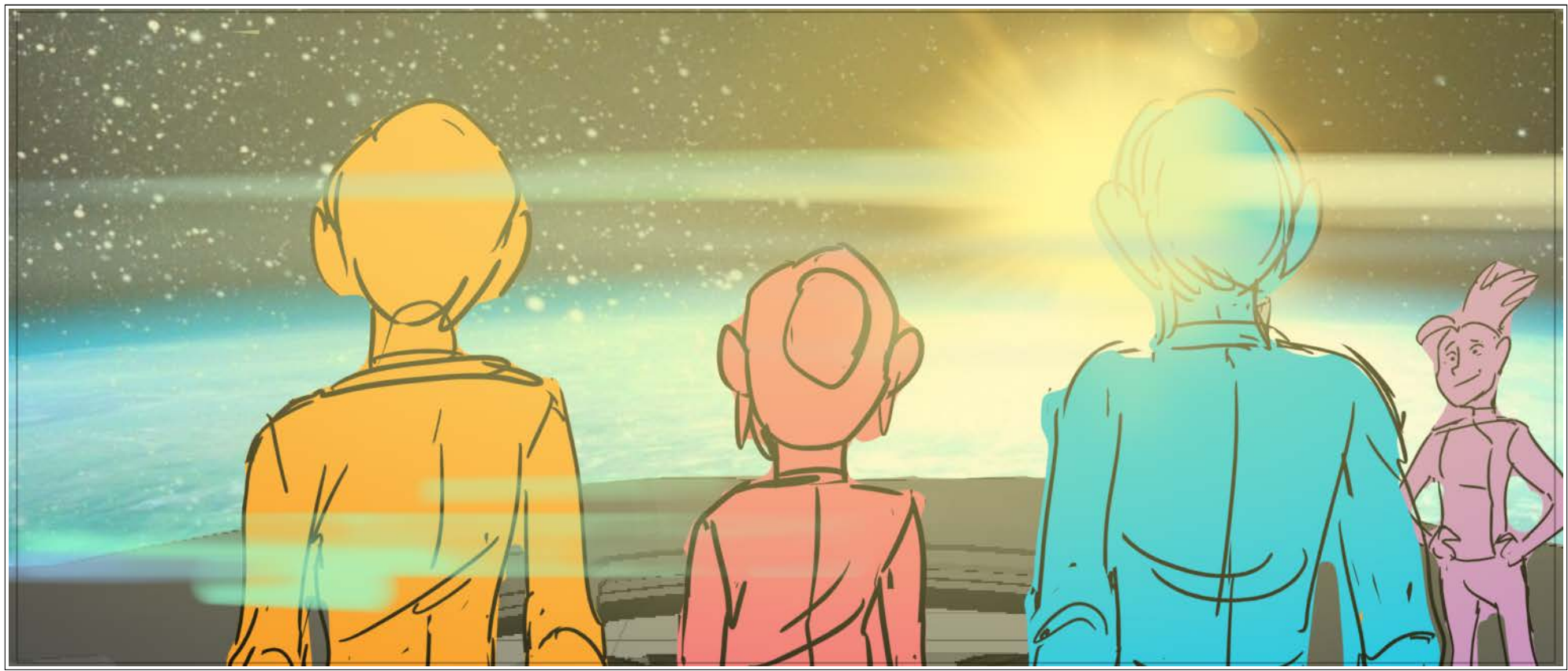

Scene	Duration	Panel	Duration
007	04:13	02C	00:12

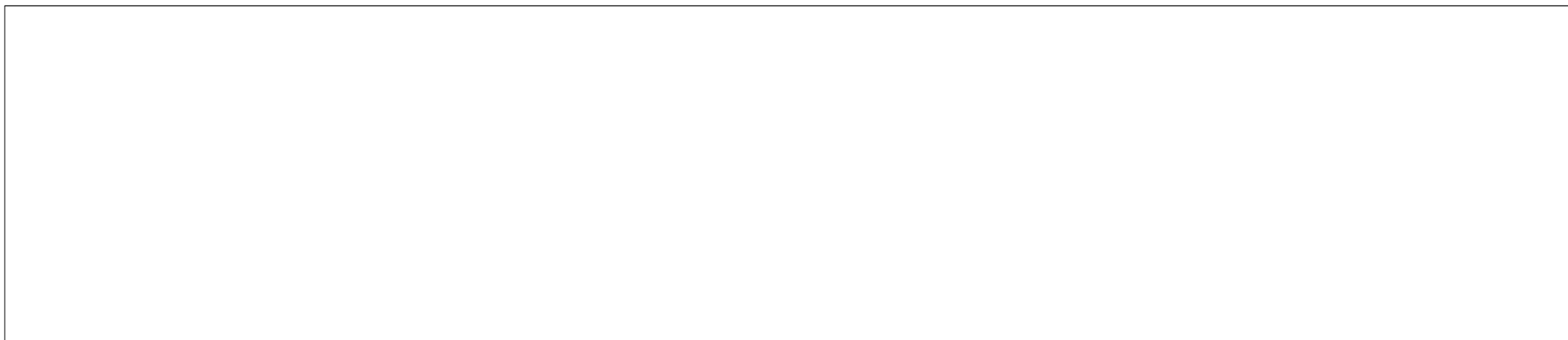
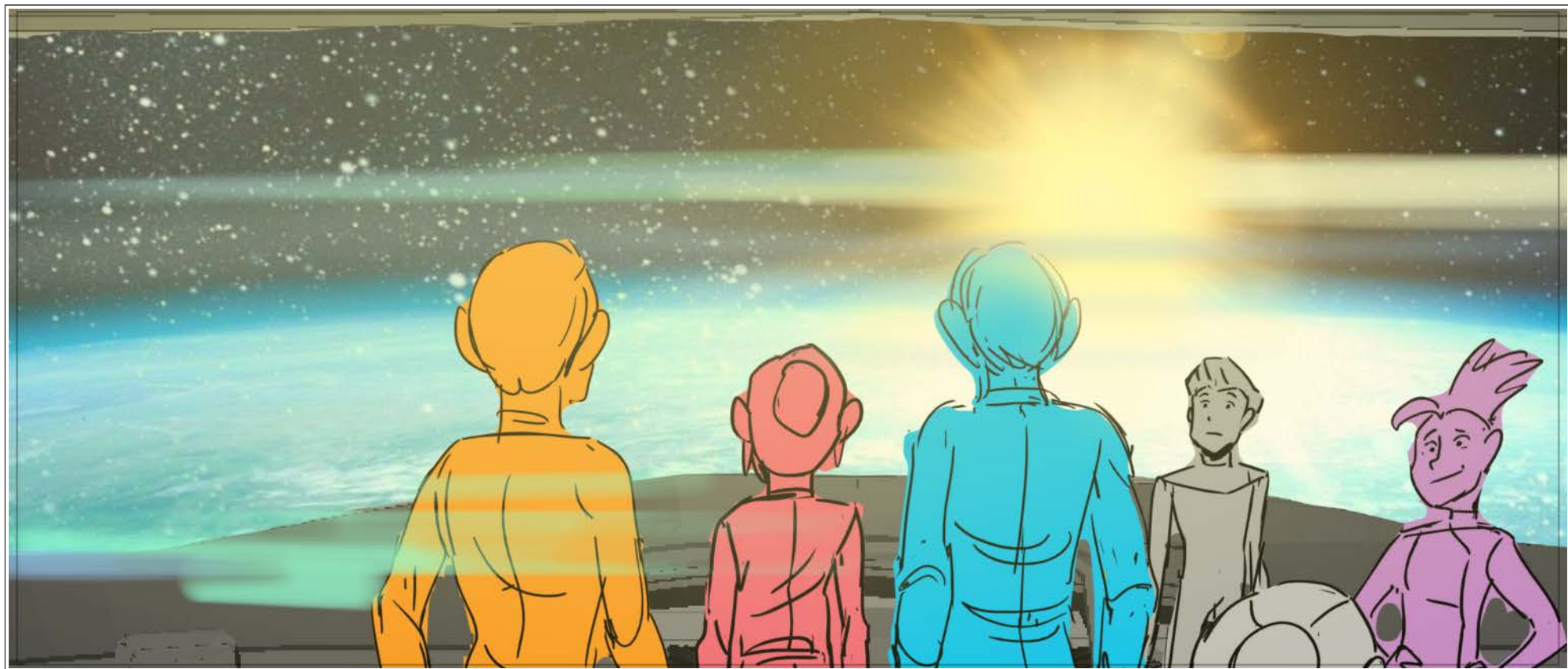

Scene	Duration	Panel	Duration
007	04:13	02C_1	00:12

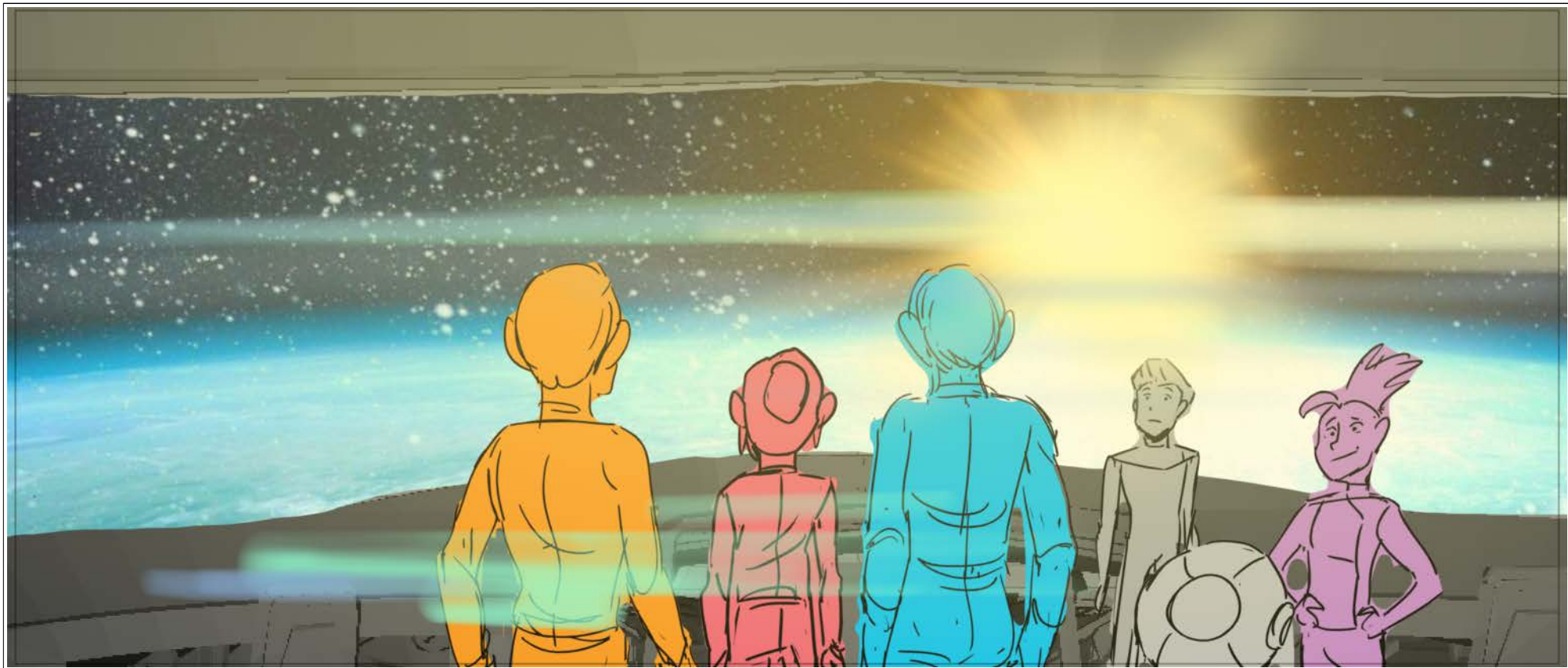

Scene	Duration	Panel	Duration
030	04:00	001	01:00

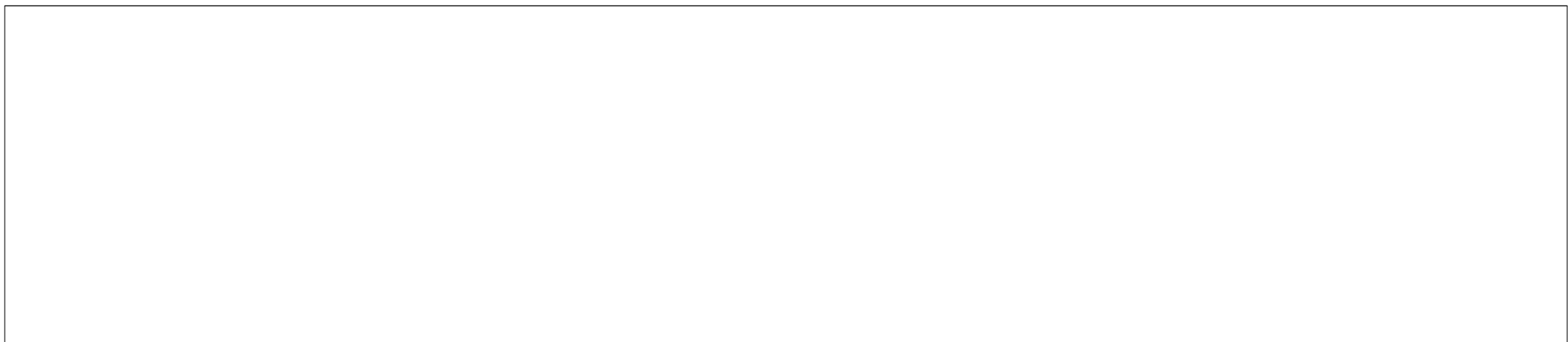
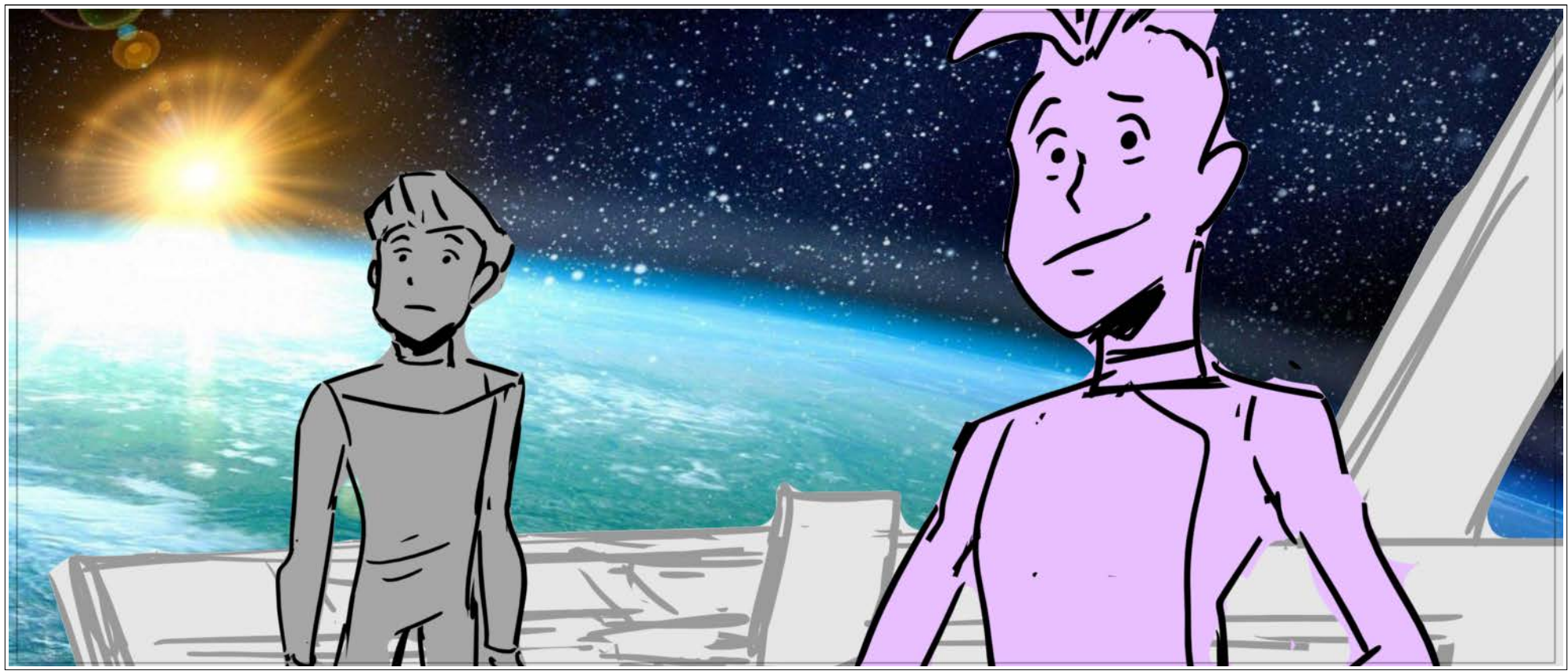

Scene	Duration	Panel	Duration
030	04:00	001A	01:00

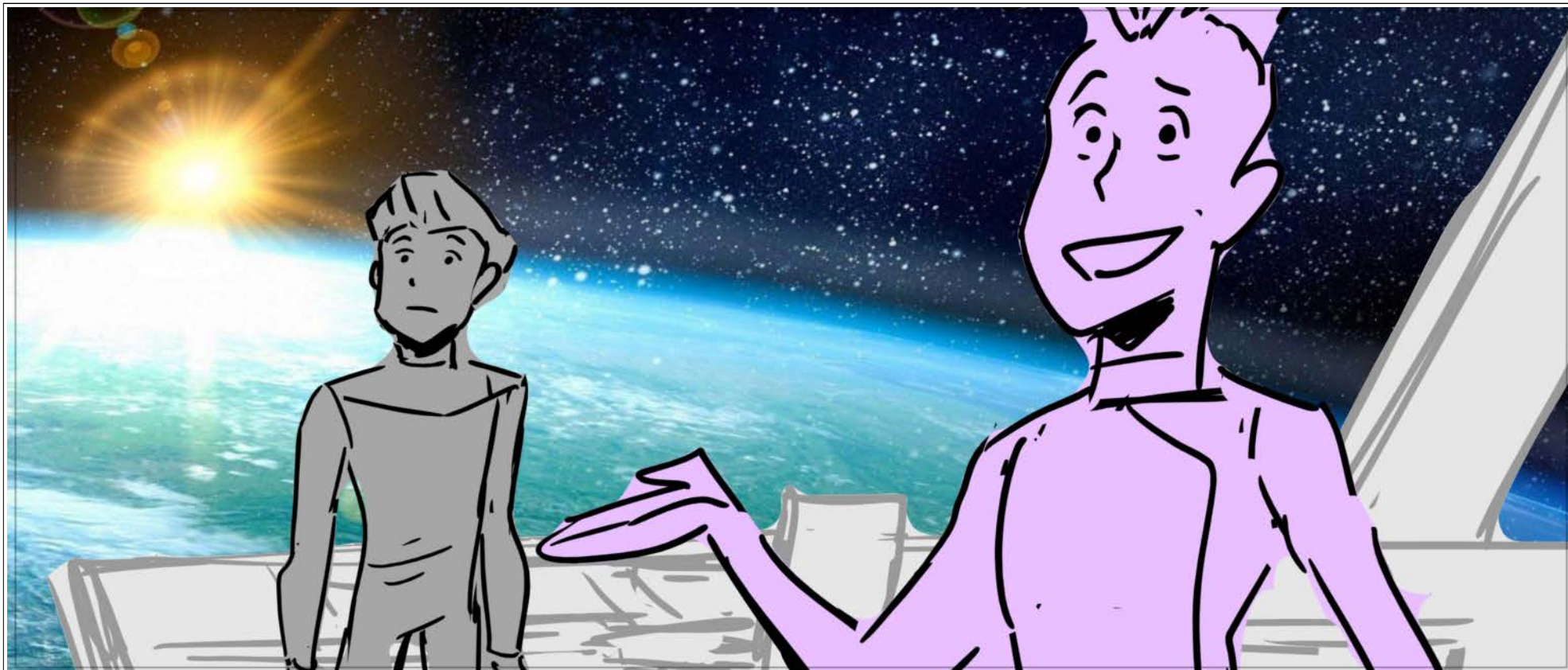

Dialog

DAL

178 Welcome to the USS Protostar.

Scene	Duration	Panel	Duration
030	04:00	001B	01:00

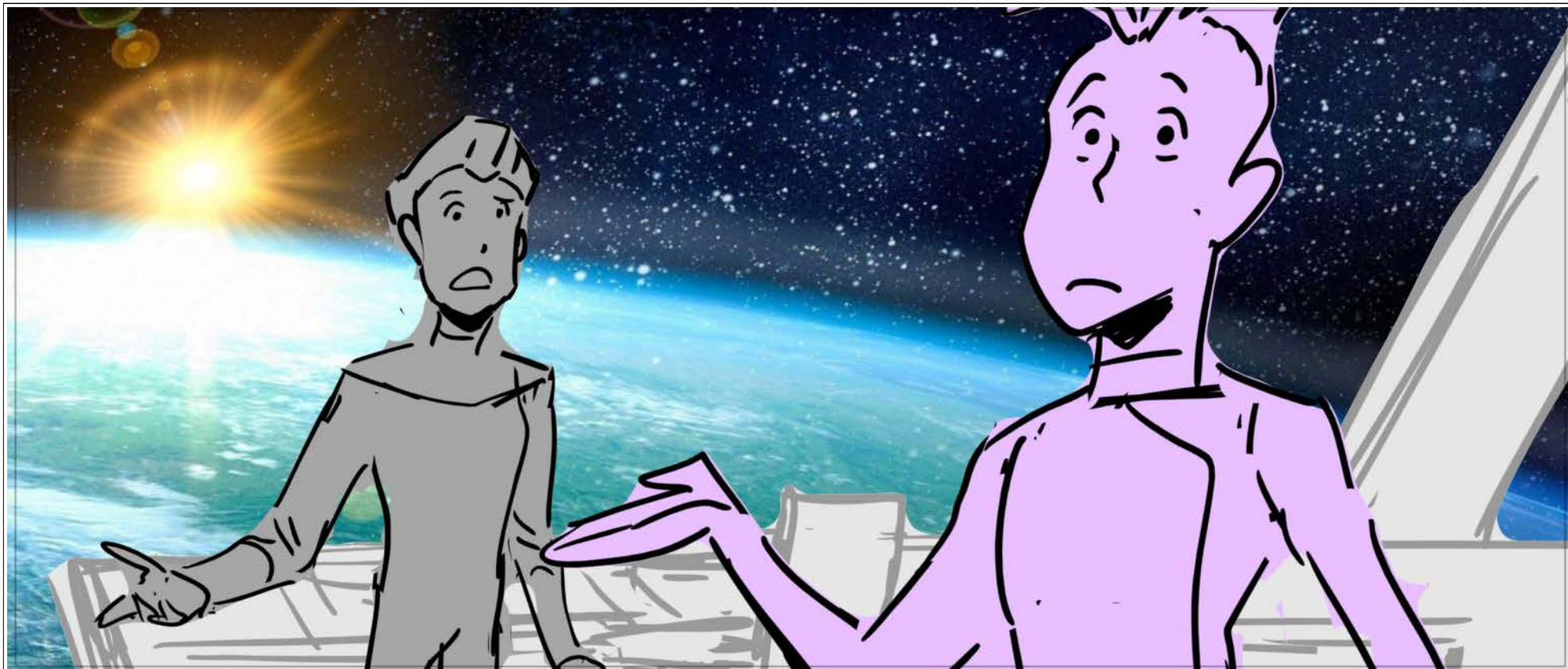

Dialog

CAPTAIN JANEWAY

179 Are you sure about this?

Scene	Duration	Panel	Duration
030	04:00	001C	01:00

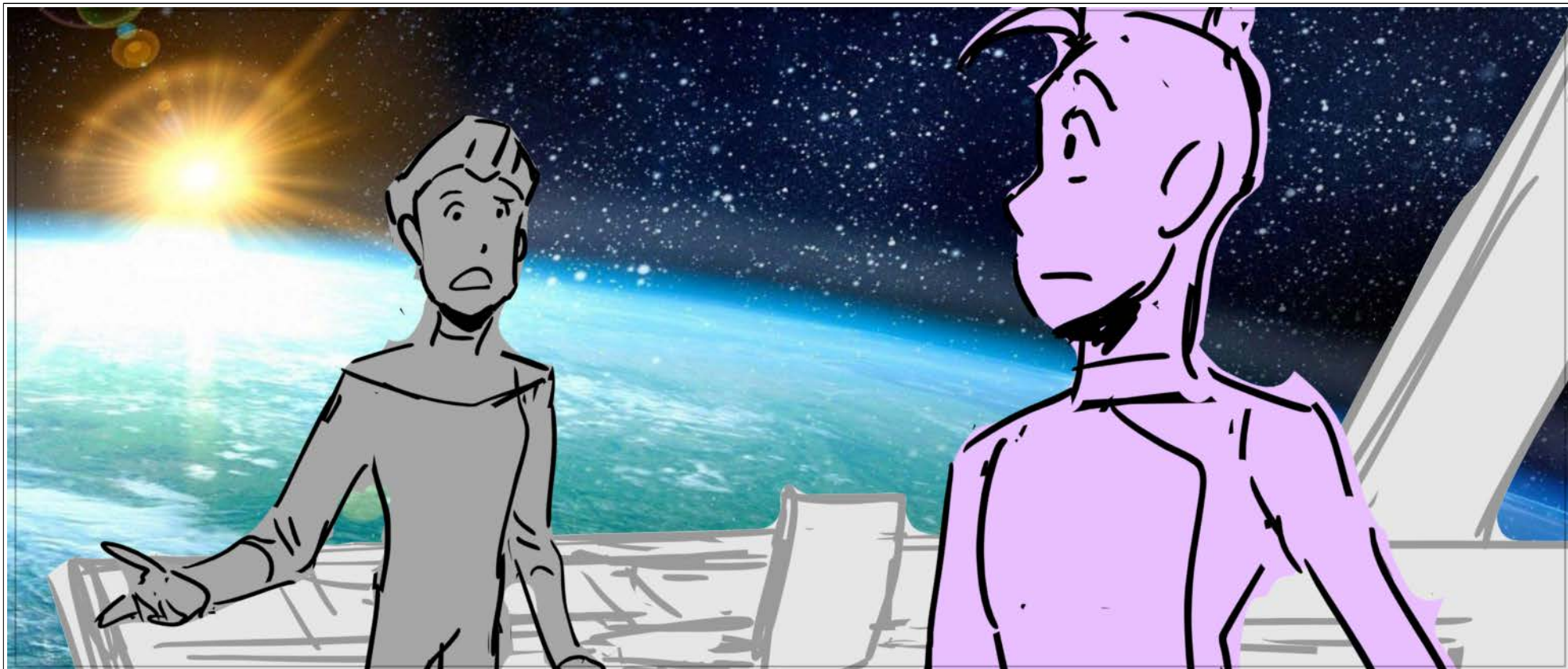

Dialog

They want to be Starfleet...

Scene	Duration	Panel	Duration
040	02:00	001	01:00



Dialog

but can they command a starship?

Scene	Duration	Panel	Duration
040	02:00	001A	01:00

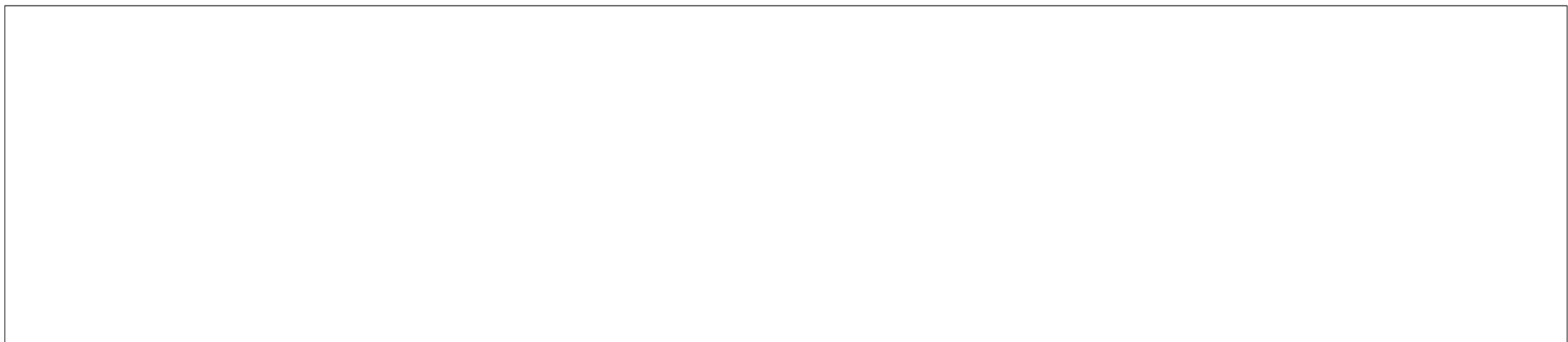
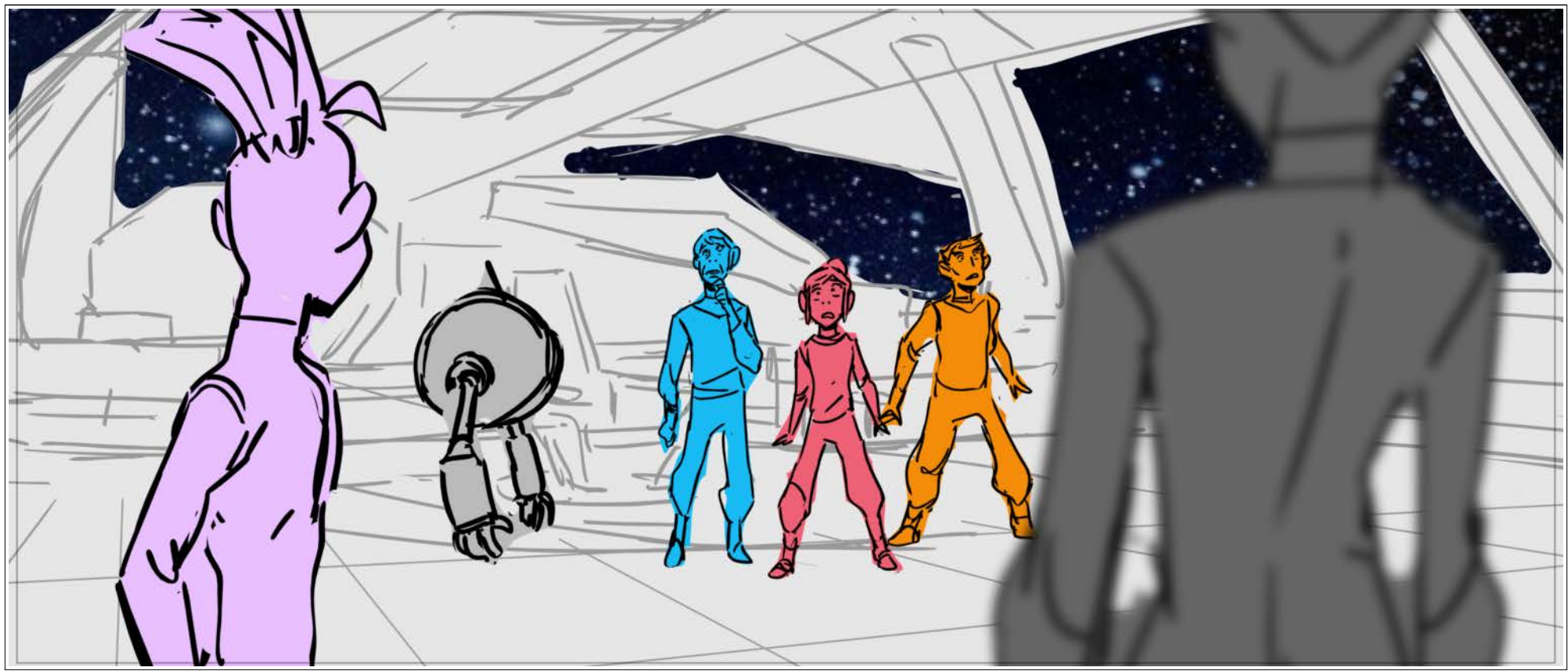

Scene	Duration	Panel	Duration
050	04:00	001	01:00

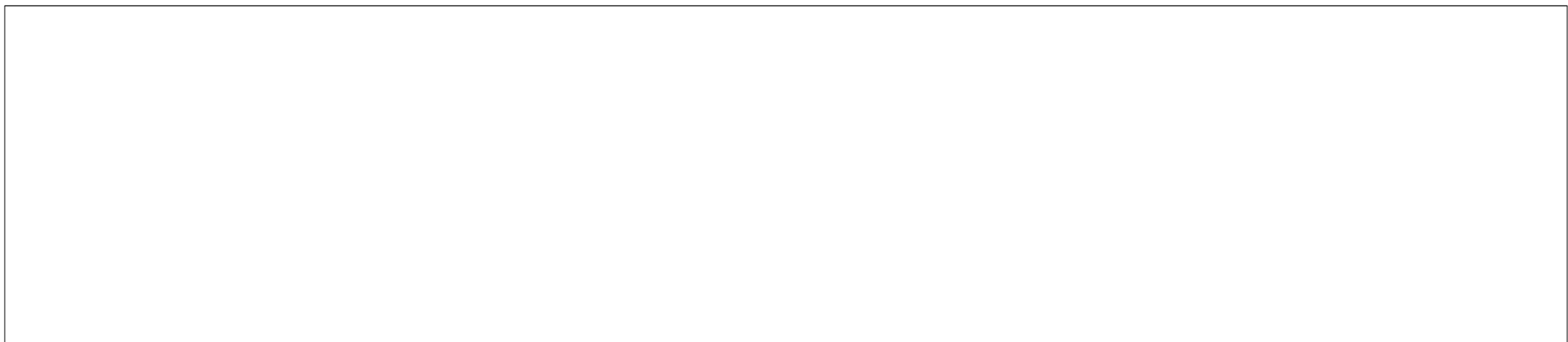

Scene	Duration	Panel	Duration
050	04:00	001A	01:00



Dialog

DAL

180 Trust me. You just have to believe.

Scene	Duration	Panel	Duration
050	04:00	001C	01:00

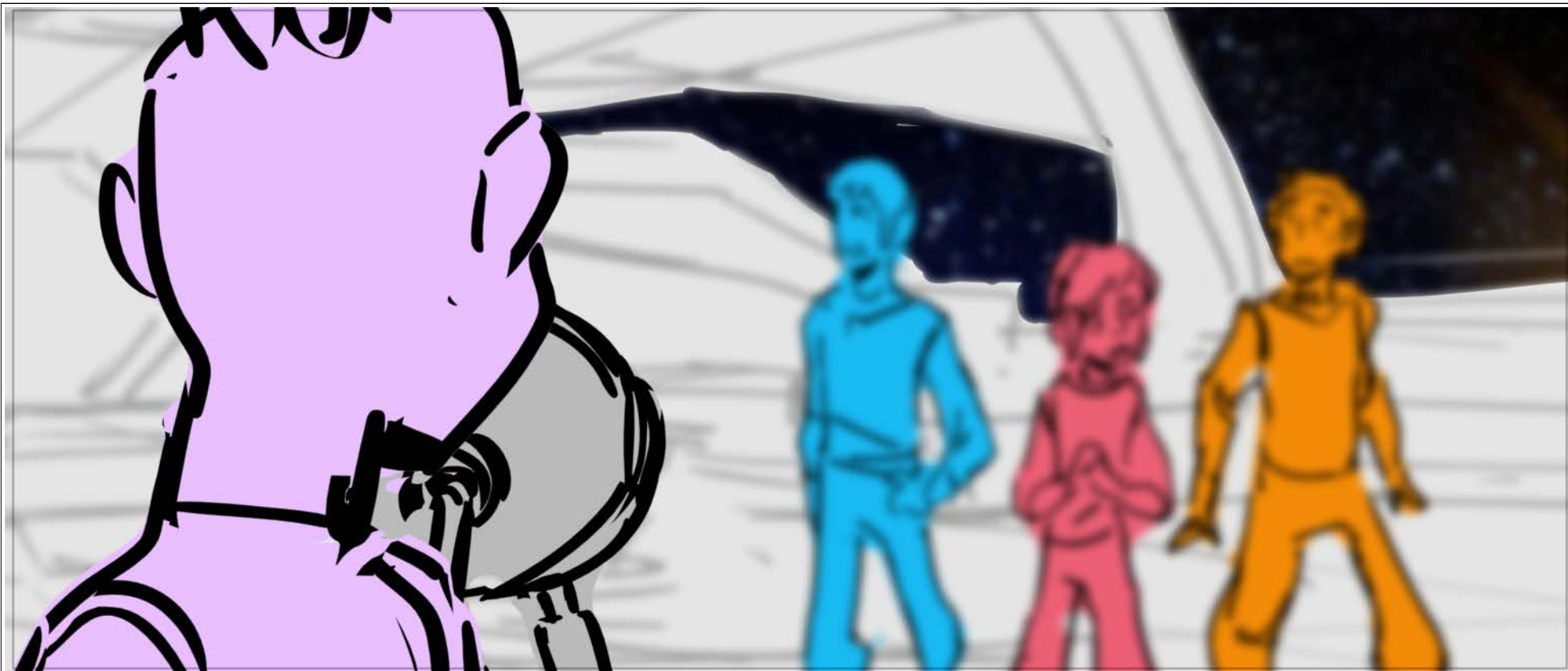

Dialog

DAL

180 Trust me. You just have to believe.

Scene	Duration	Panel	Duration
050	04:00	001B	01:00



Dialog

DAL

180 Trust me. You just have to believe.

Scene	Duration	Panel	Duration
060	02:00	001	01:00

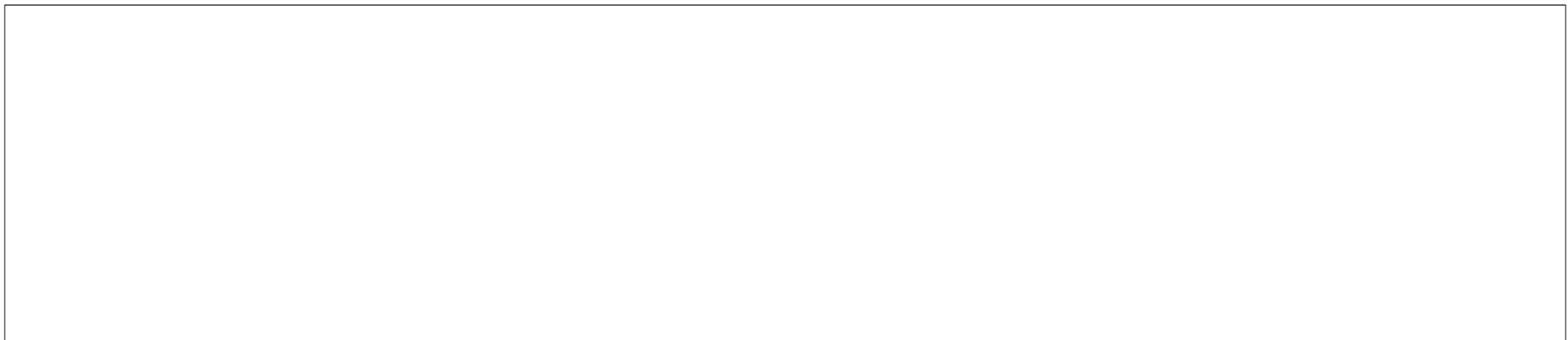

Scene	Duration	Panel	Duration
060	02:00	001A	01:00

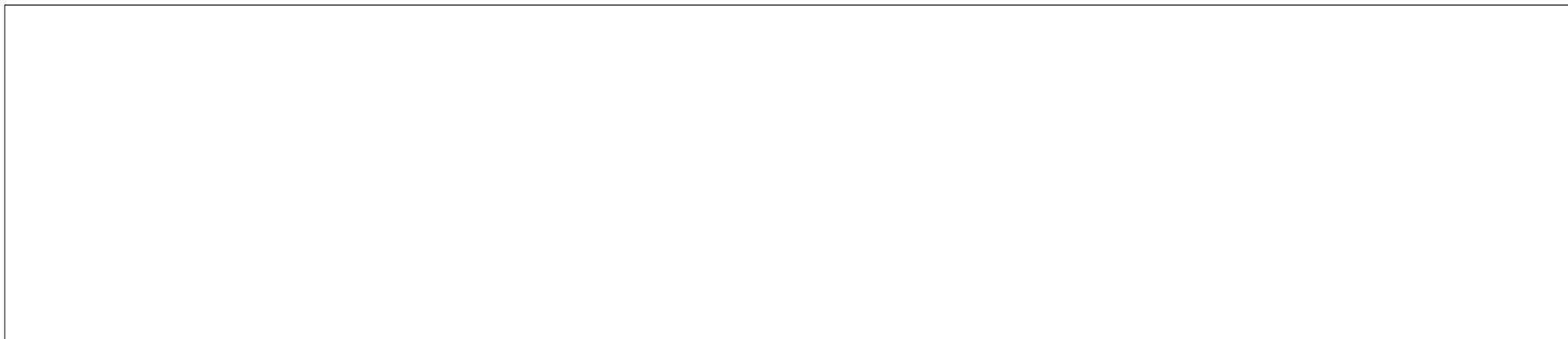
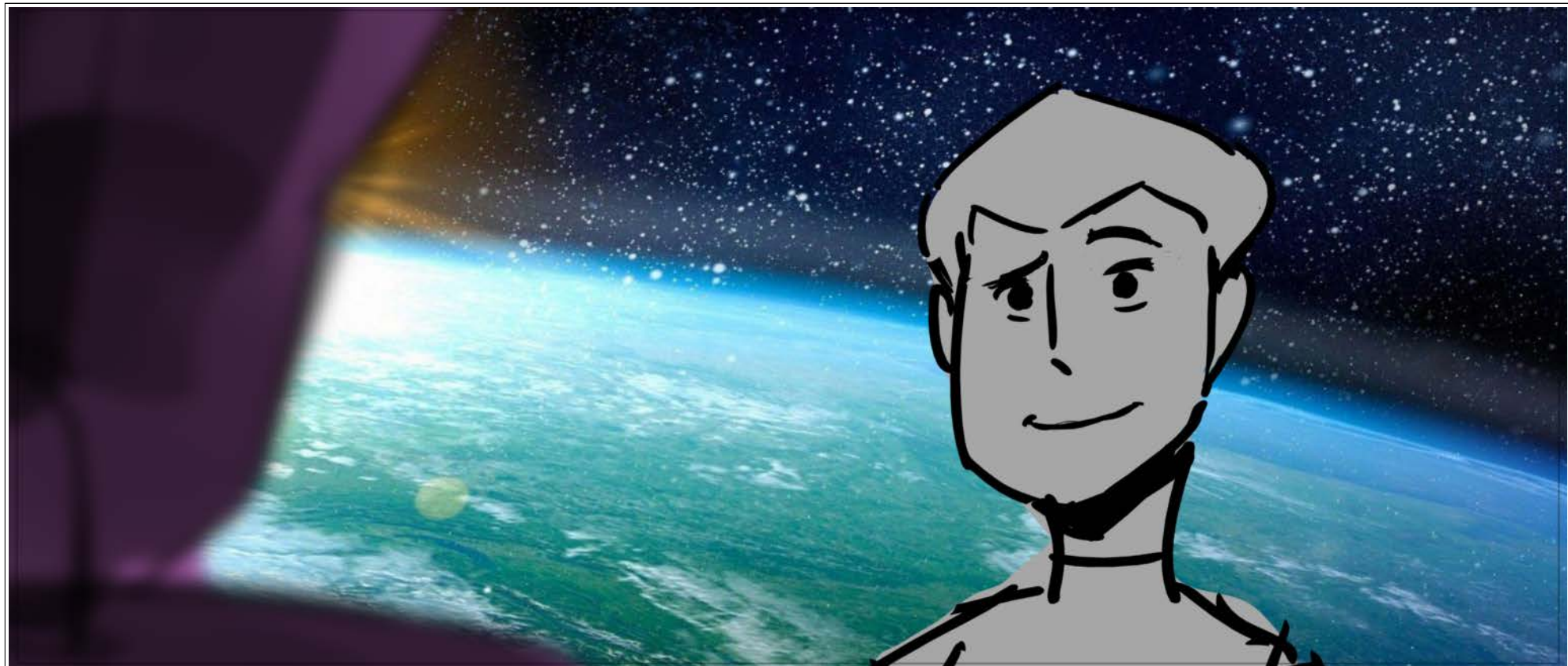

Scene	Duration	Panel	Duration
090	02:00	001A_1	01:00



Action Notes

CHARACTERS LOOK UNEASY

Scene	Duration	Panel	Duration
090	02:00	001A	01:00



Action Notes

CHARACTERS LOOK UNEASY

Scene	070_A	Duration	01:00	Panel	001	Duration	01:00
-------	-------	----------	-------	-------	-----	----------	-------

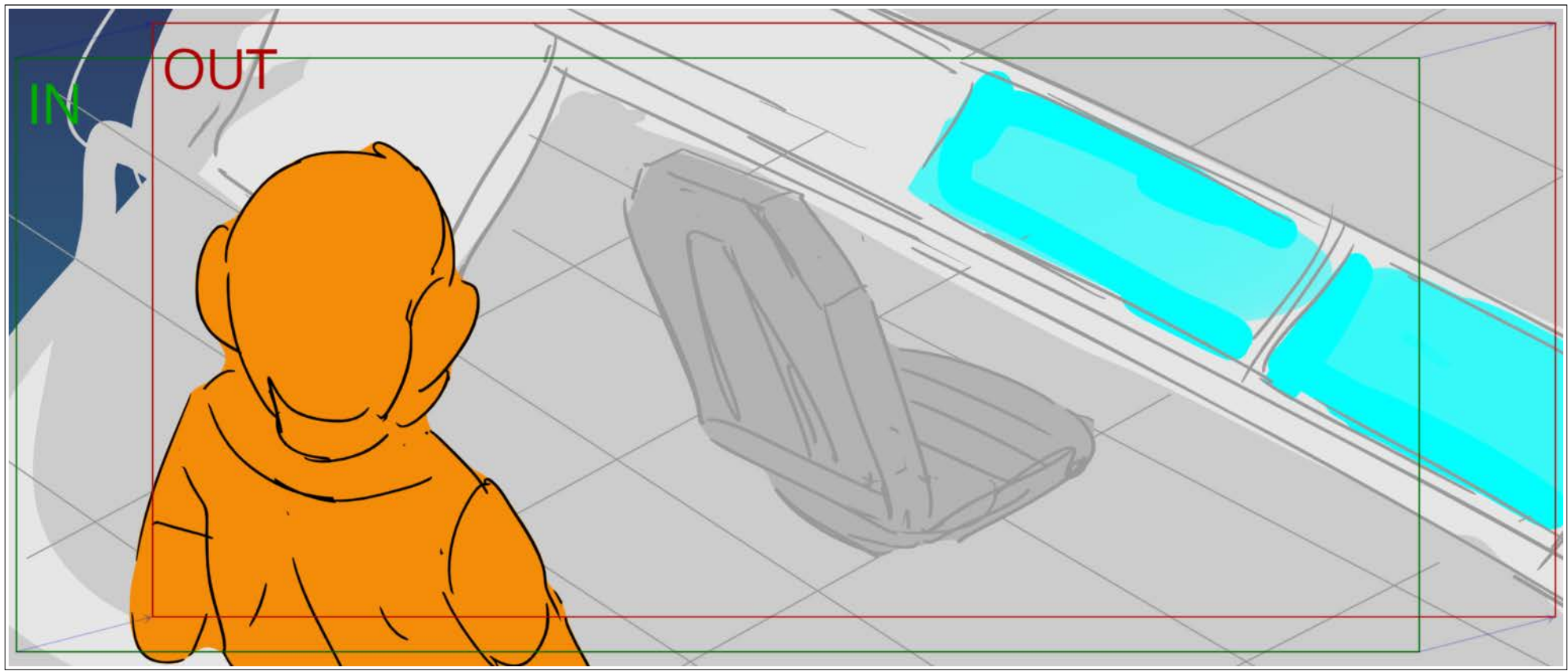

Action Notes
CAMERA PANS OVER HIGH TECH CONTROLS

Scene	Duration	Panel	Duration
080_A	01:00	001	01:00

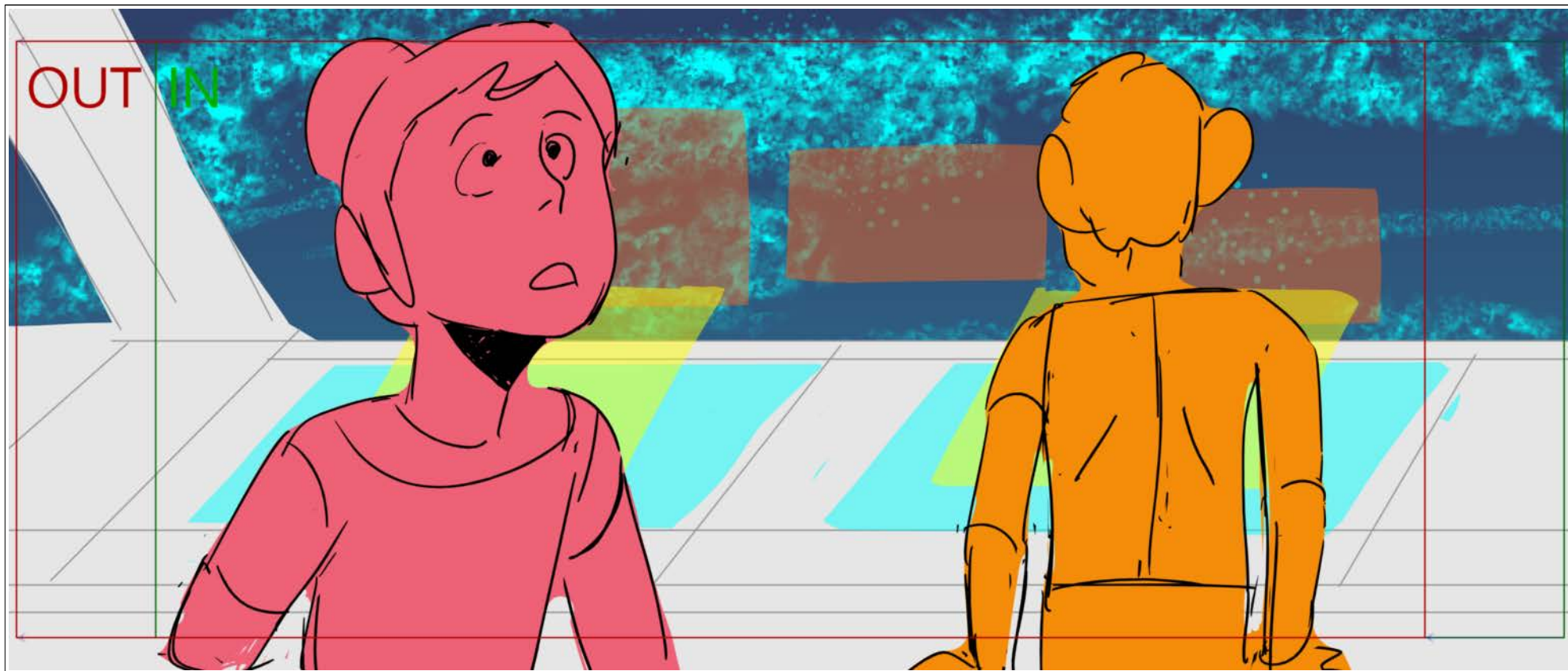

Action Notes

CAMERA PANS OVER HIGH TECH CONTROLS

Scene	Duration	Panel	Duration
070	01:00	001	01:00

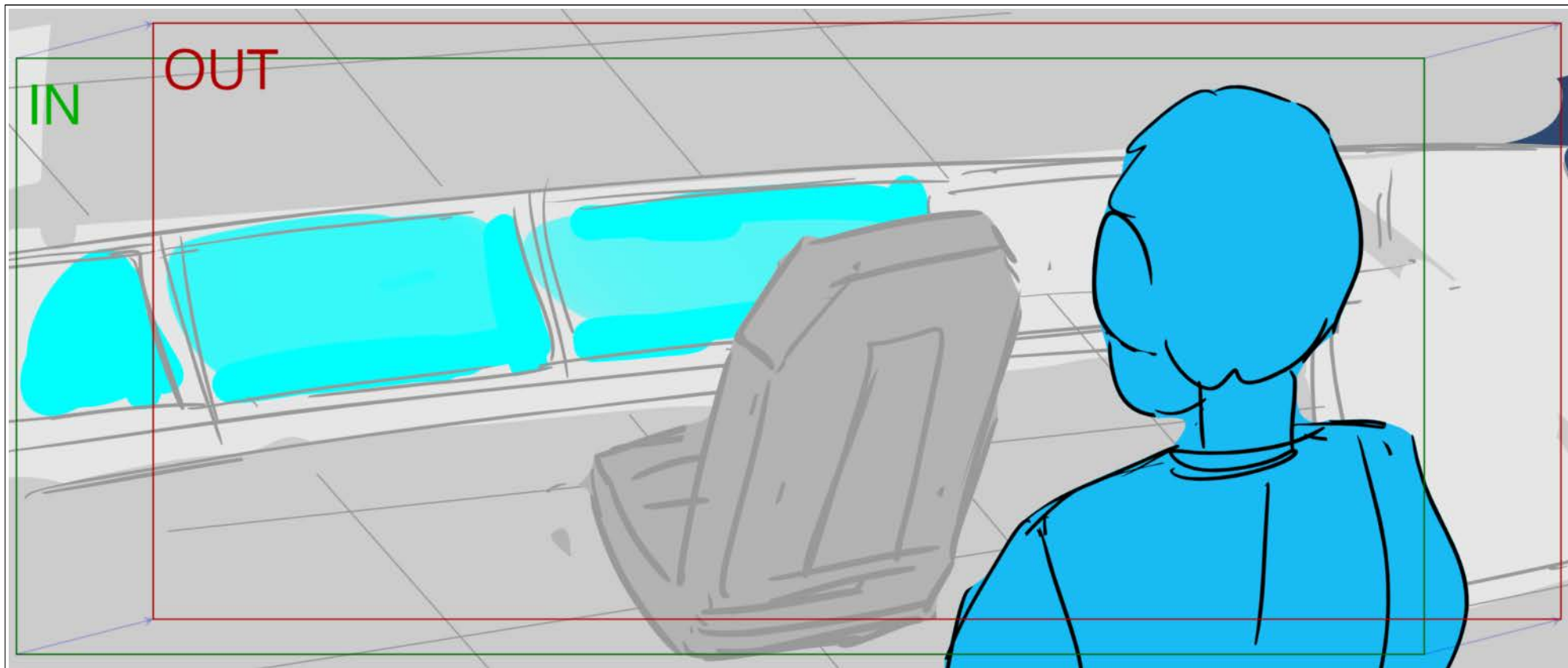

Action Notes

CAMERA PANS OVER HIGH TECH CONTROLS

Scene	Duration	Panel	Duration
080	01:00	001	00:11



Action Notes

CAMERA PANS OVER HIGH TECH CONTROLS

Scene	Duration	Panel	Duration
080	01:00	002	00:13



Action Notes

CAMERA PANS OVER HIGH TECH CONTROLS

Scene	Duration	Panel	Duration
100	03:00	001	01:00

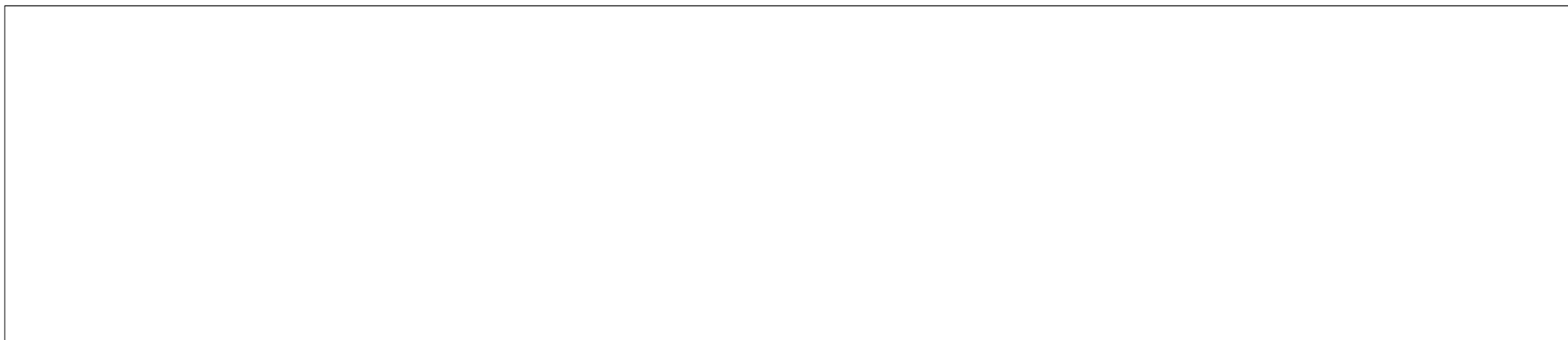
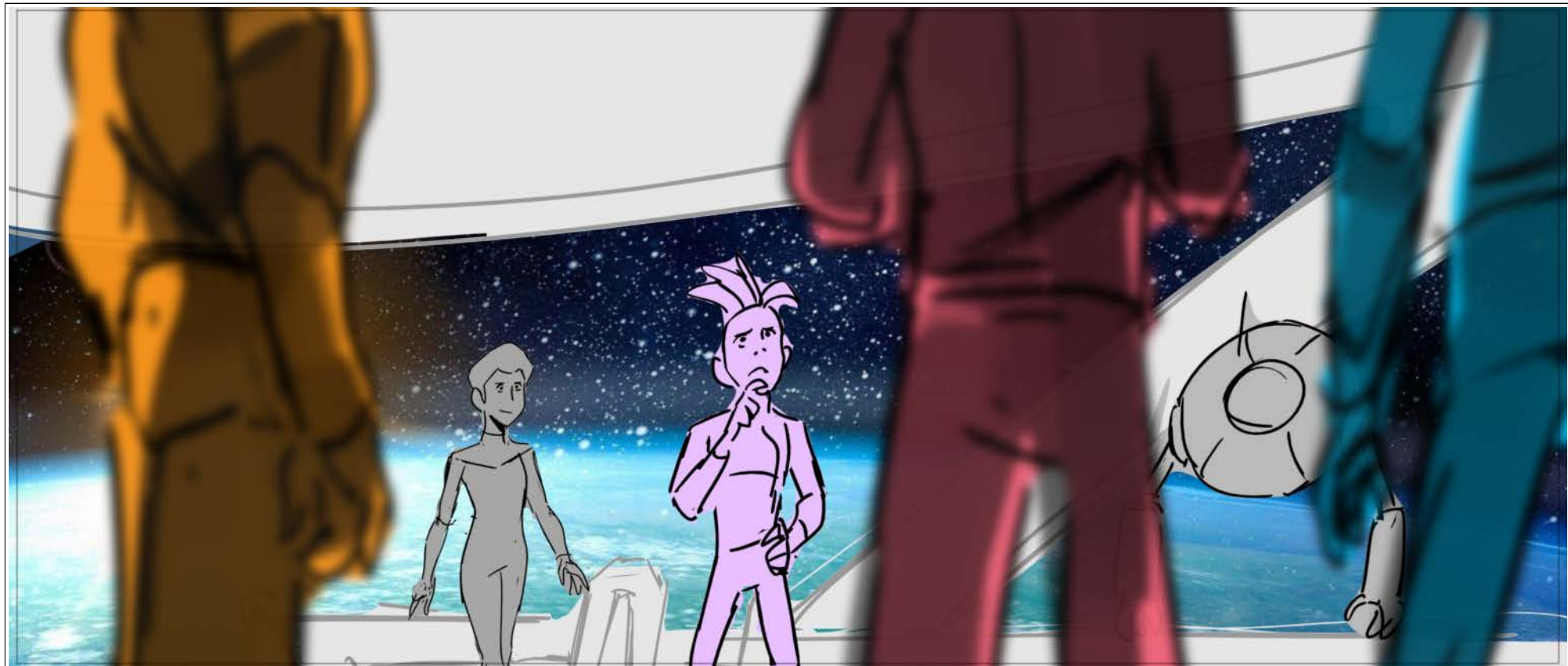

Scene	Duration	Panel	Duration
100	03:00	001_A	01:00

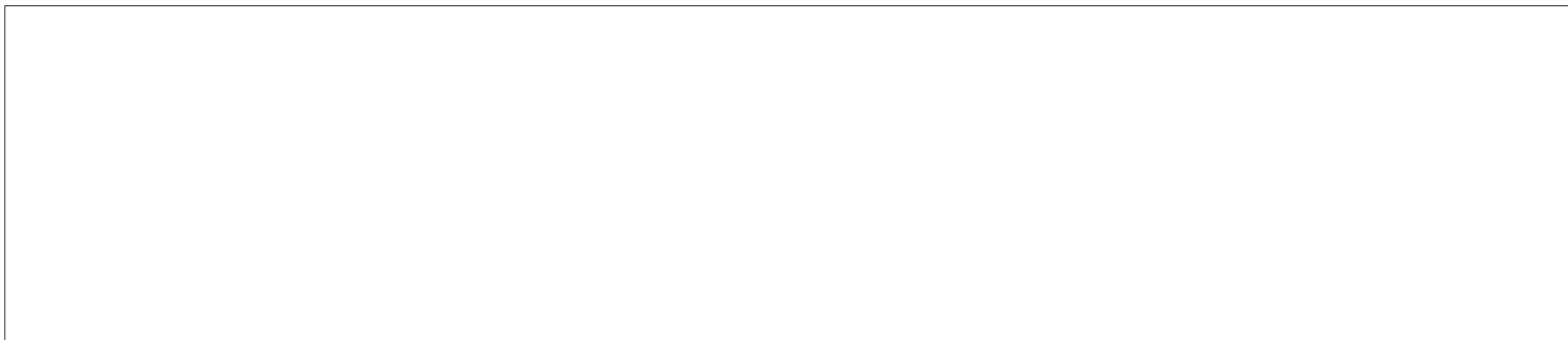
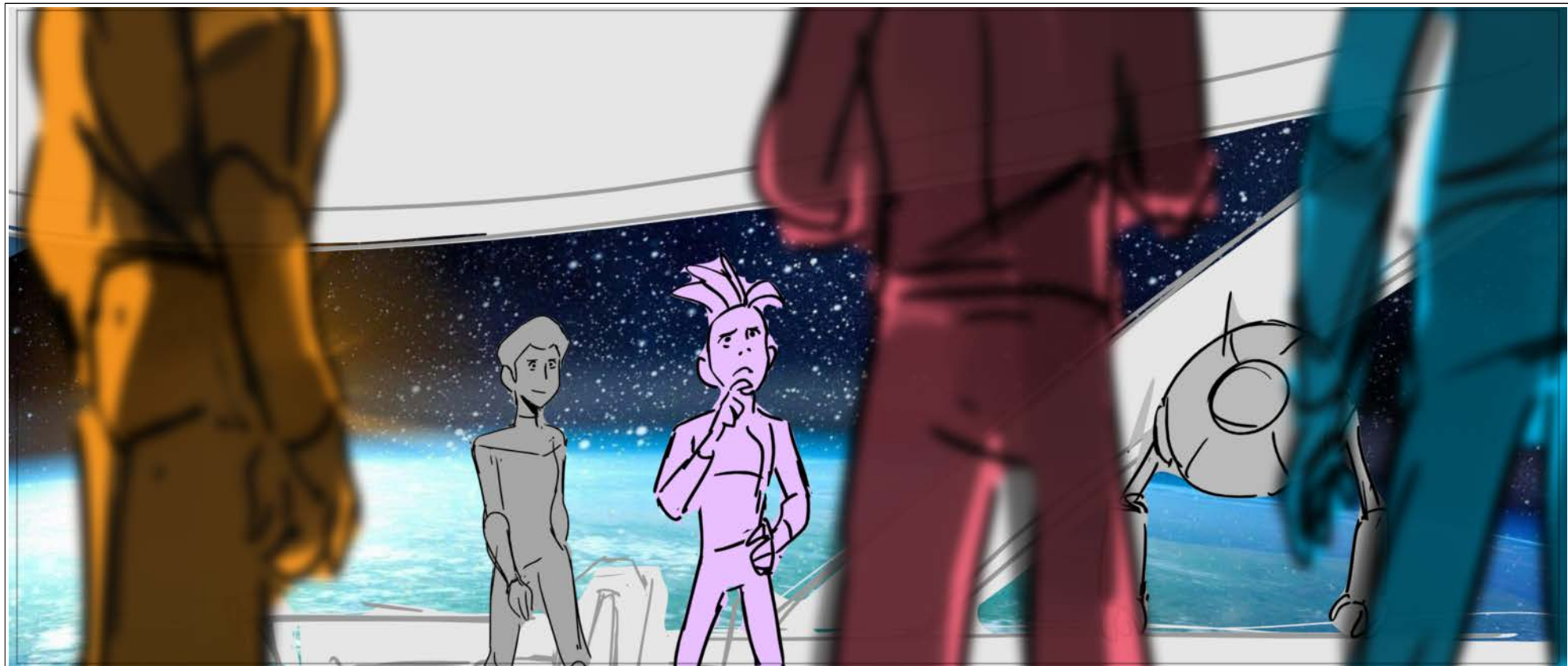

Scene	Duration	Panel	Duration
100	03:00	001_A_1	01:00

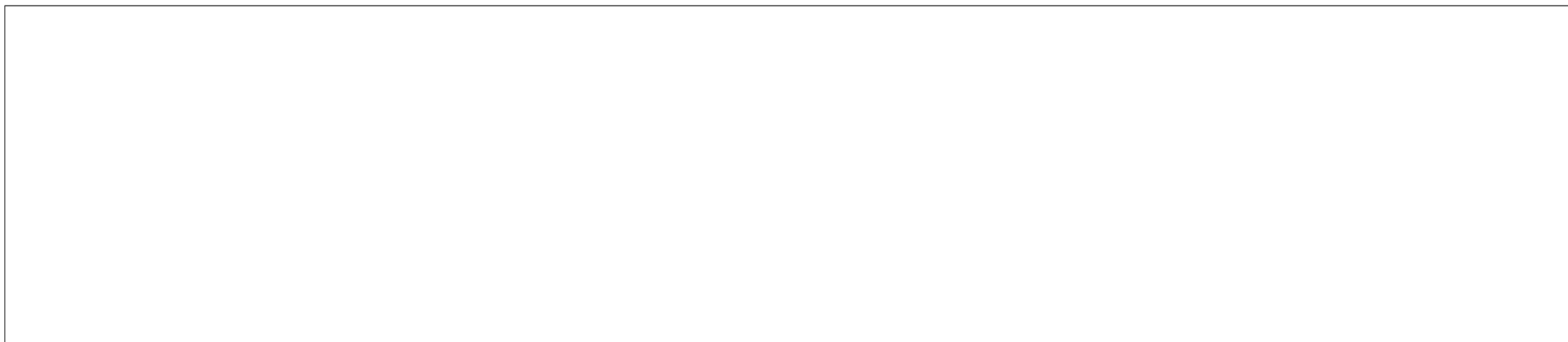
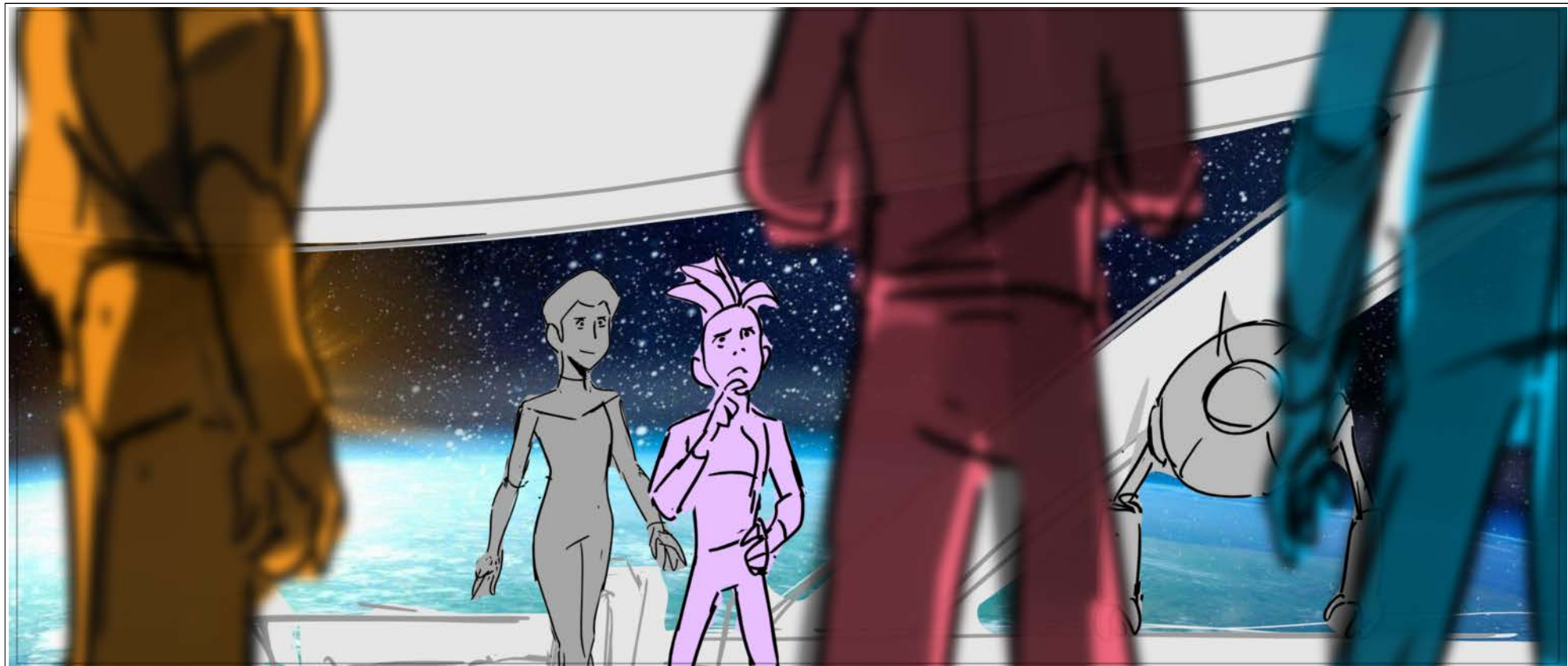

Scene	Duration	Panel	Duration
110	04:00	001	01:00

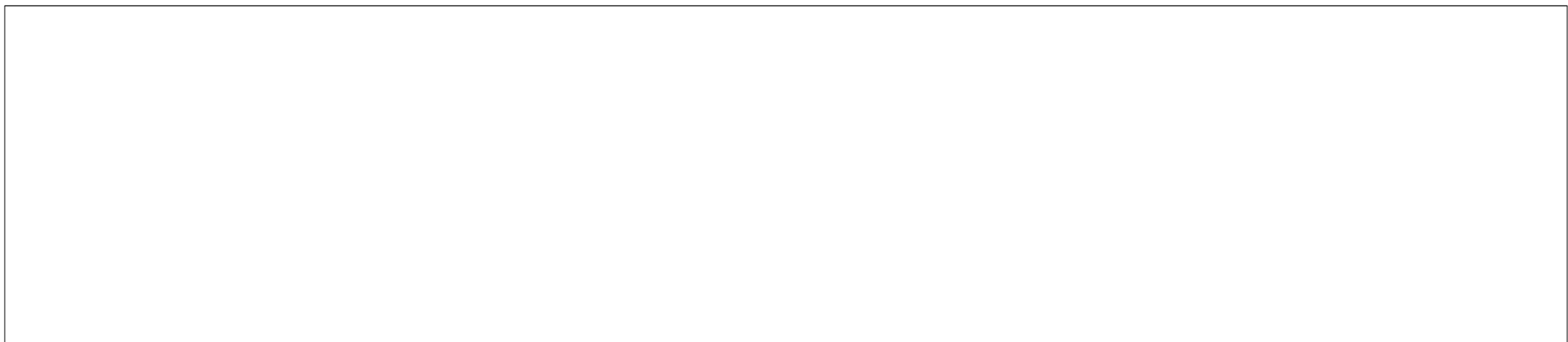
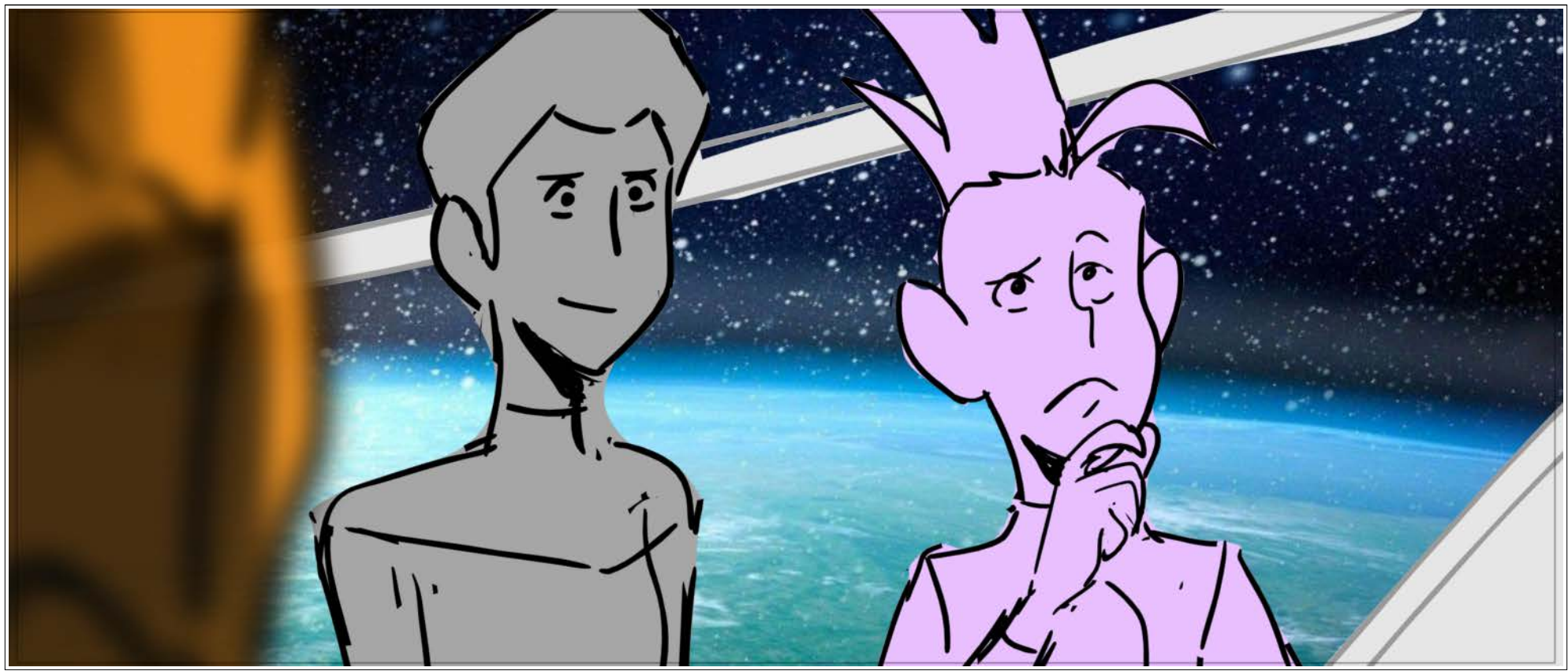

Scene	Duration	Panel	Duration
110	04:00	001A999	01:00

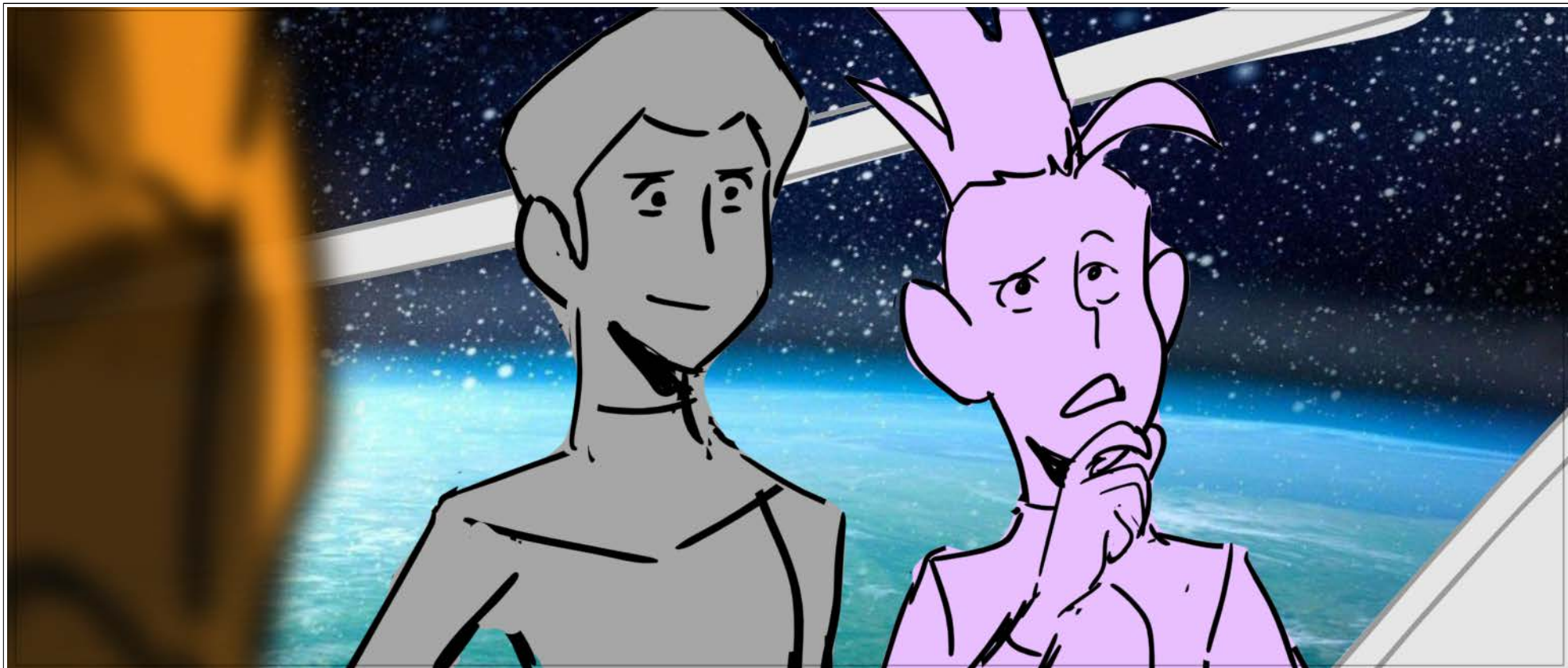

Dialog

DAL (CONT'D)

181 They're a bit retro.

Scene	Duration	Panel	Duration
110	04:00	001A0	01:00

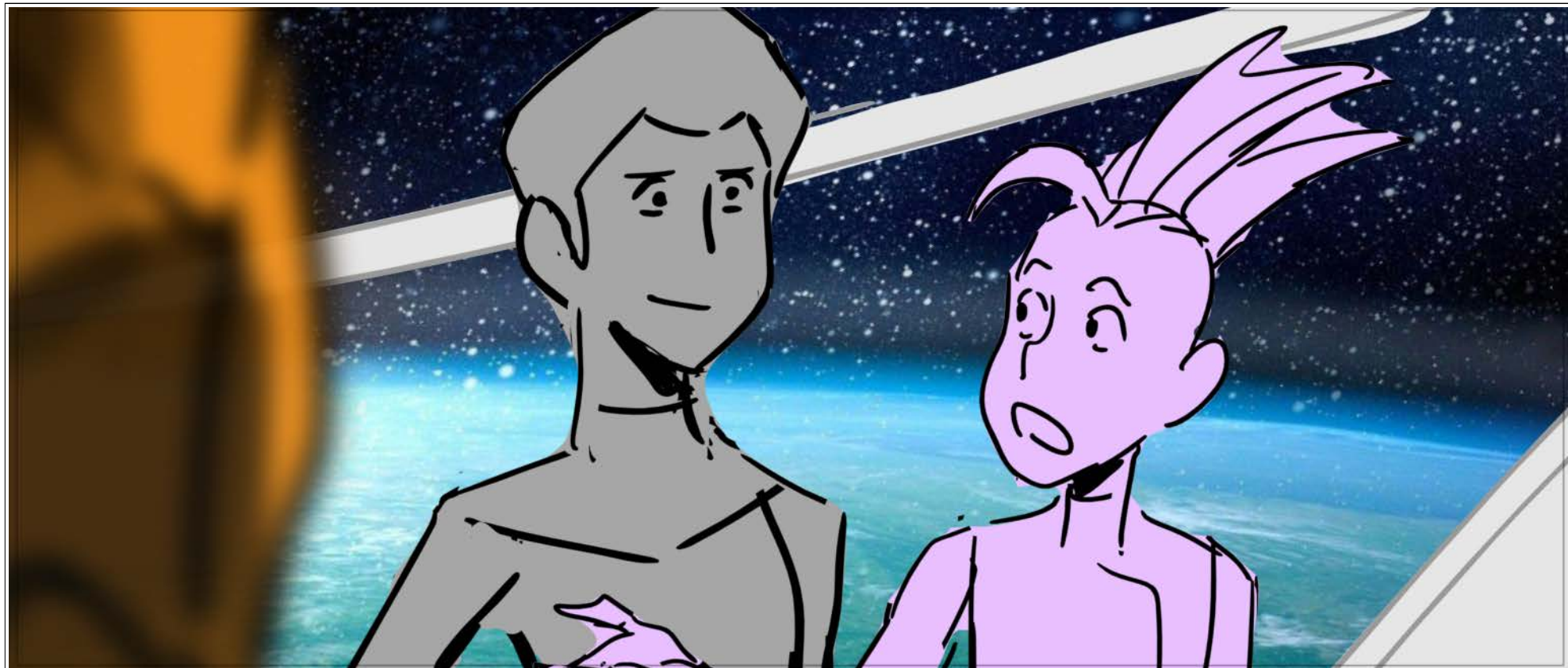

Dialog

DAL (CONT'D)

Got anything more old school?

Scene	Duration	Panel	Duration
110	04:00	001C	01:00

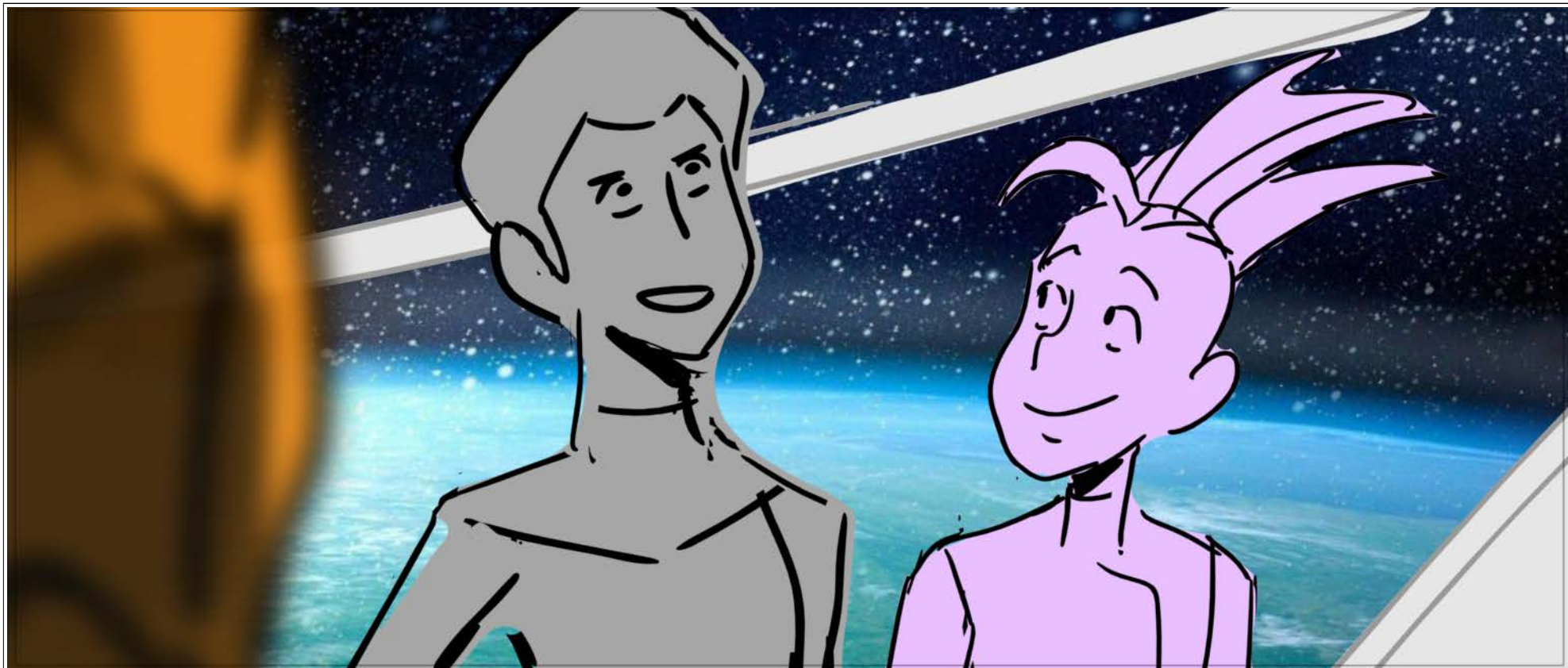

Dialog

CAPTAIN JANEWAY

182 Computer. Load Constitution class holo-console, mid 23rd Century.

Scene	Duration	Panel	Duration
120	12:00	001	01:00

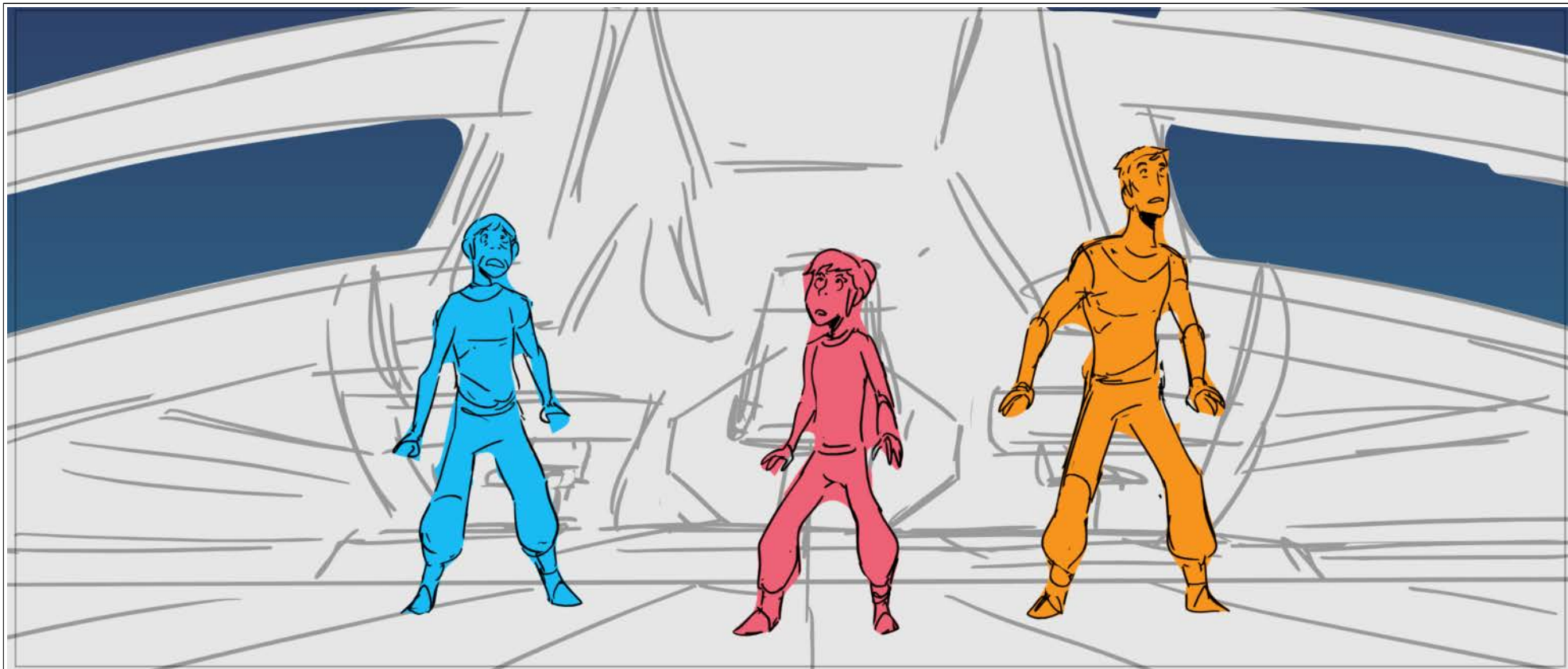

Dialog

Translate command inputs to the Protostar's helm.

Scene	Duration	Panel	Duration
120	12:00	001A999	01:00

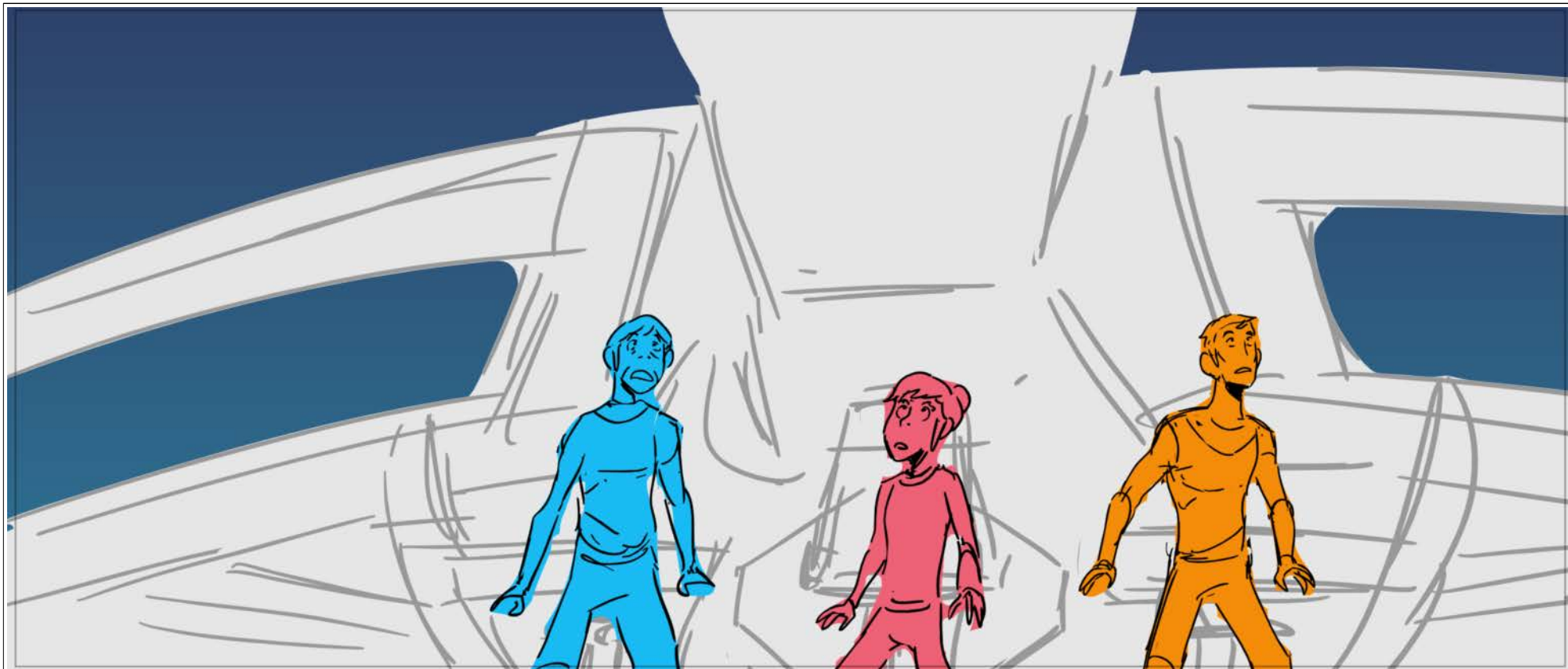

Dialog

Translate command inputs to the Protostar's helm.

Scene	Duration	Panel	Duration
120	12:00	001A0	01:00



Dialog

Translate command inputs to the Protostar's helm.

Action Notes

CAMERA TRACKS HOLOGRAM TRANSITIONING FROM CEILING AND AROUND CHARACTERS, TURNING BRIDGE TO TOS BRIDGE

Scene	Duration	Panel	Duration
120	12:00	001A1	00:11

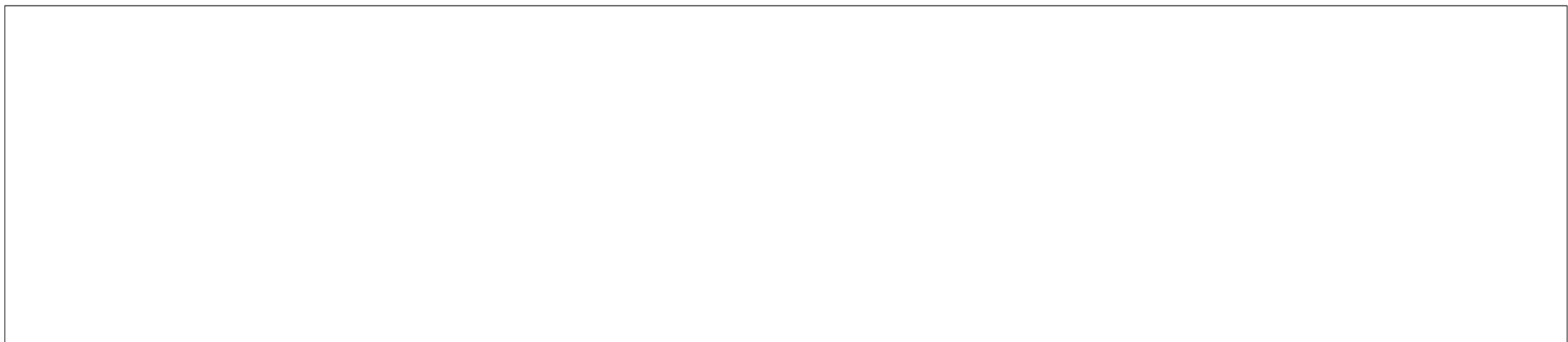
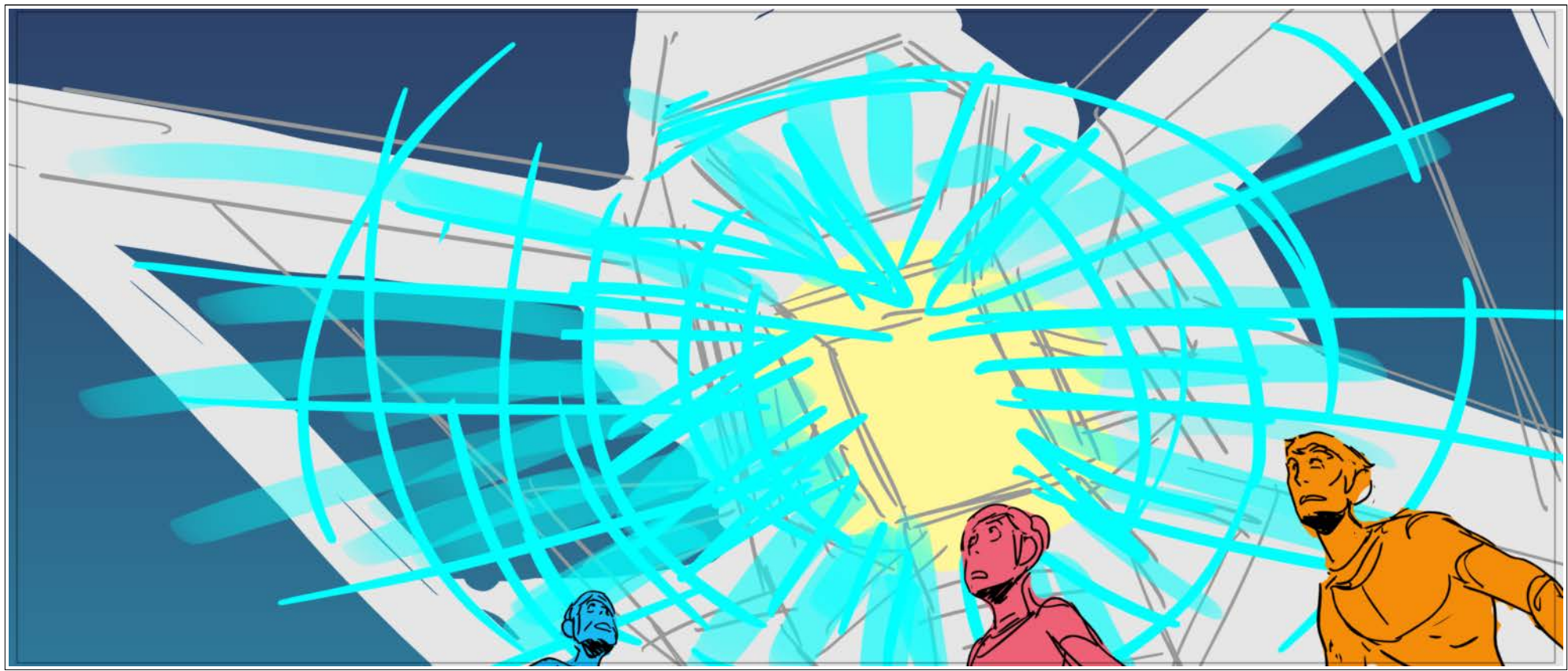

Scene	Duration	Panel	Duration
120	12:00	001A2	00:13

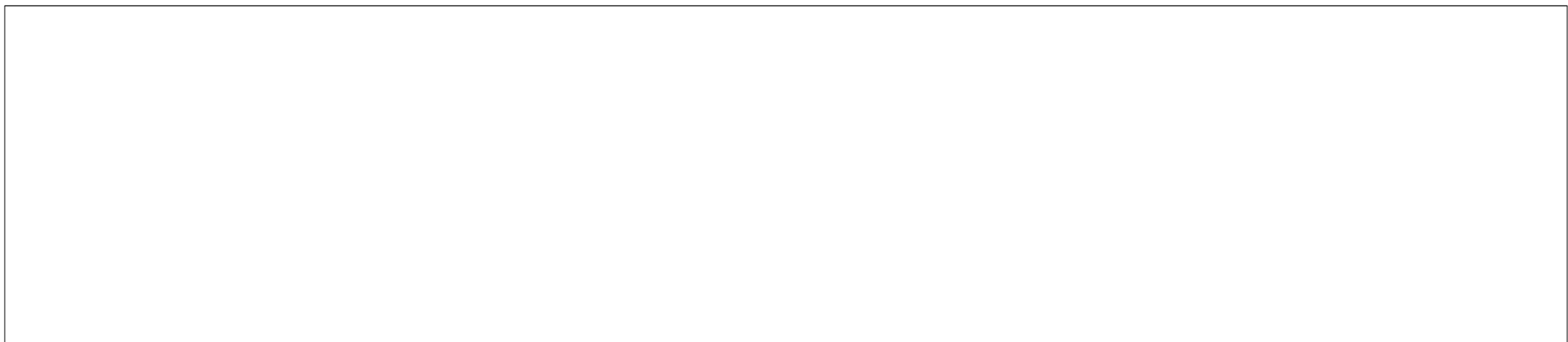
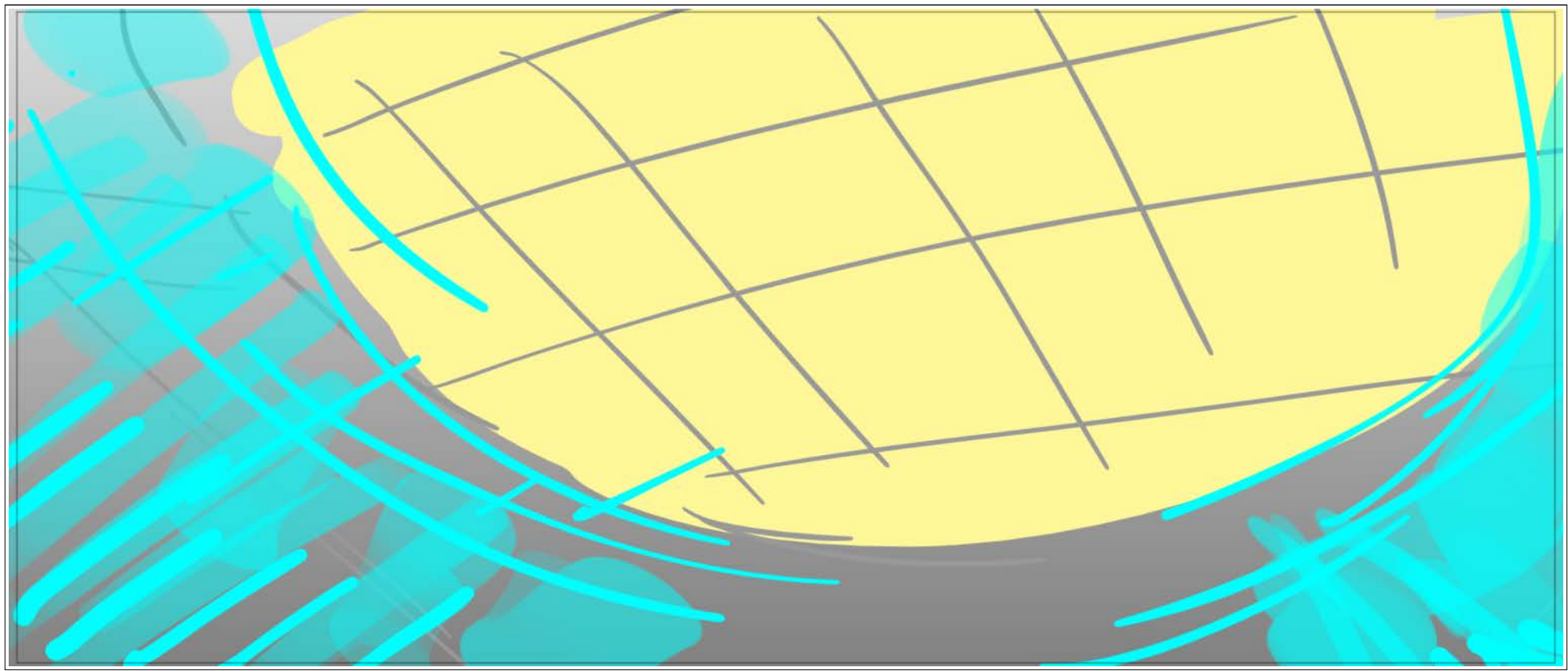

Scene	Duration	Panel	Duration
120	12:00	001A	01:00

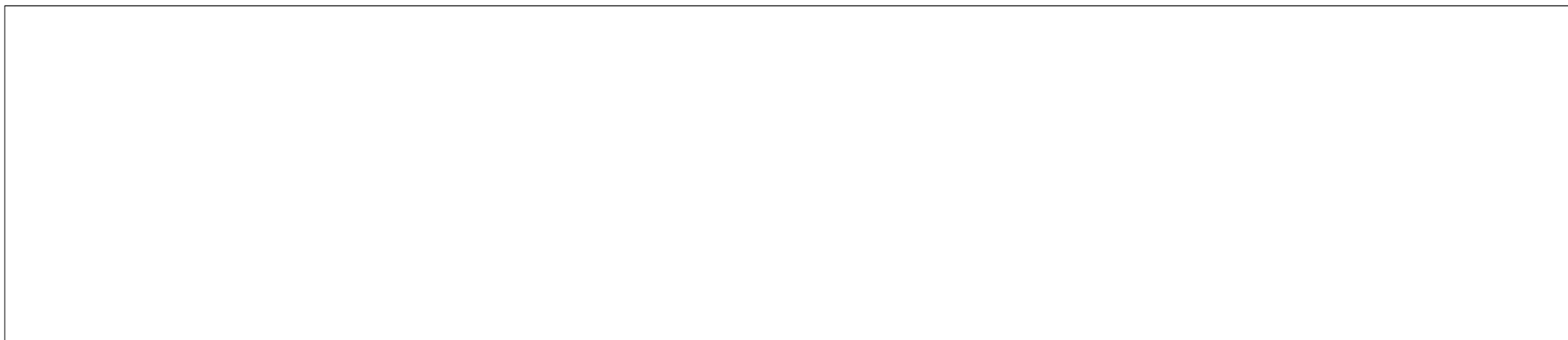
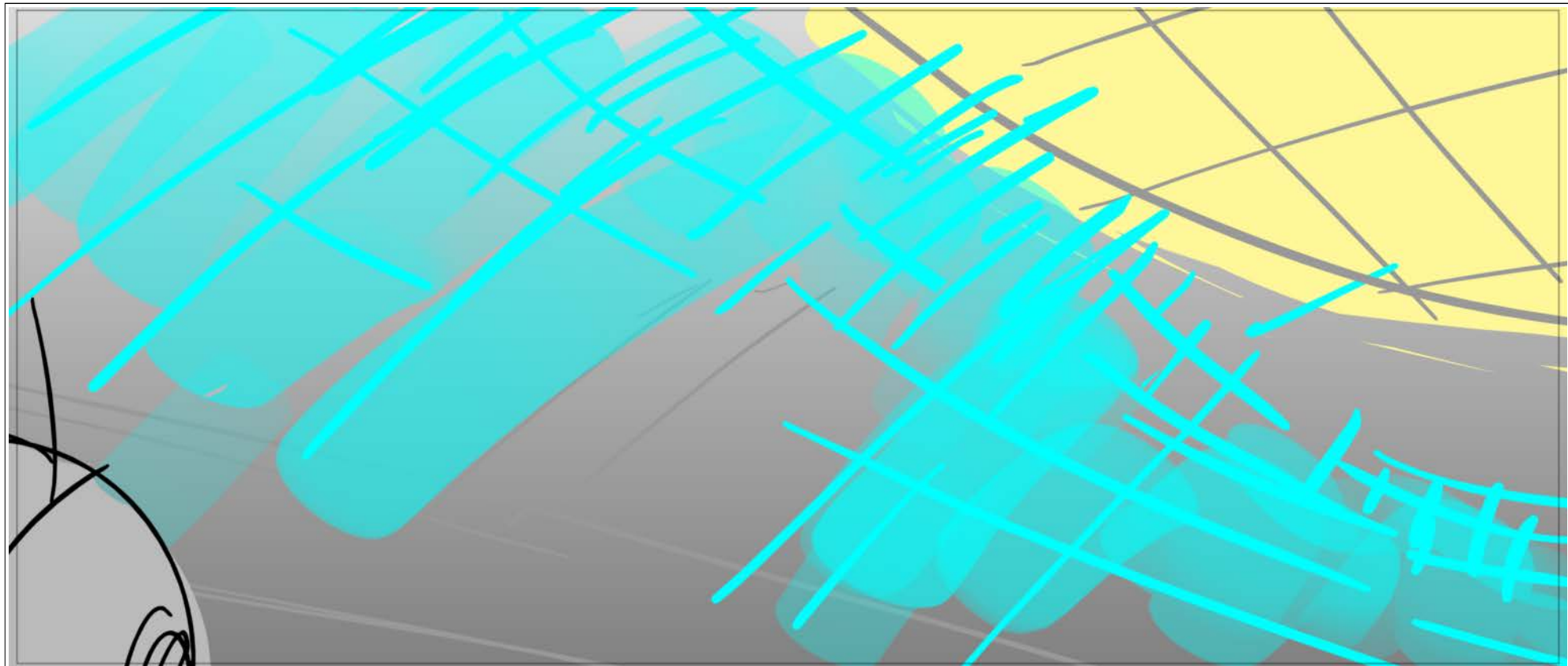

Scene	Duration	Panel	Duration
120	12:00	001D	00:12

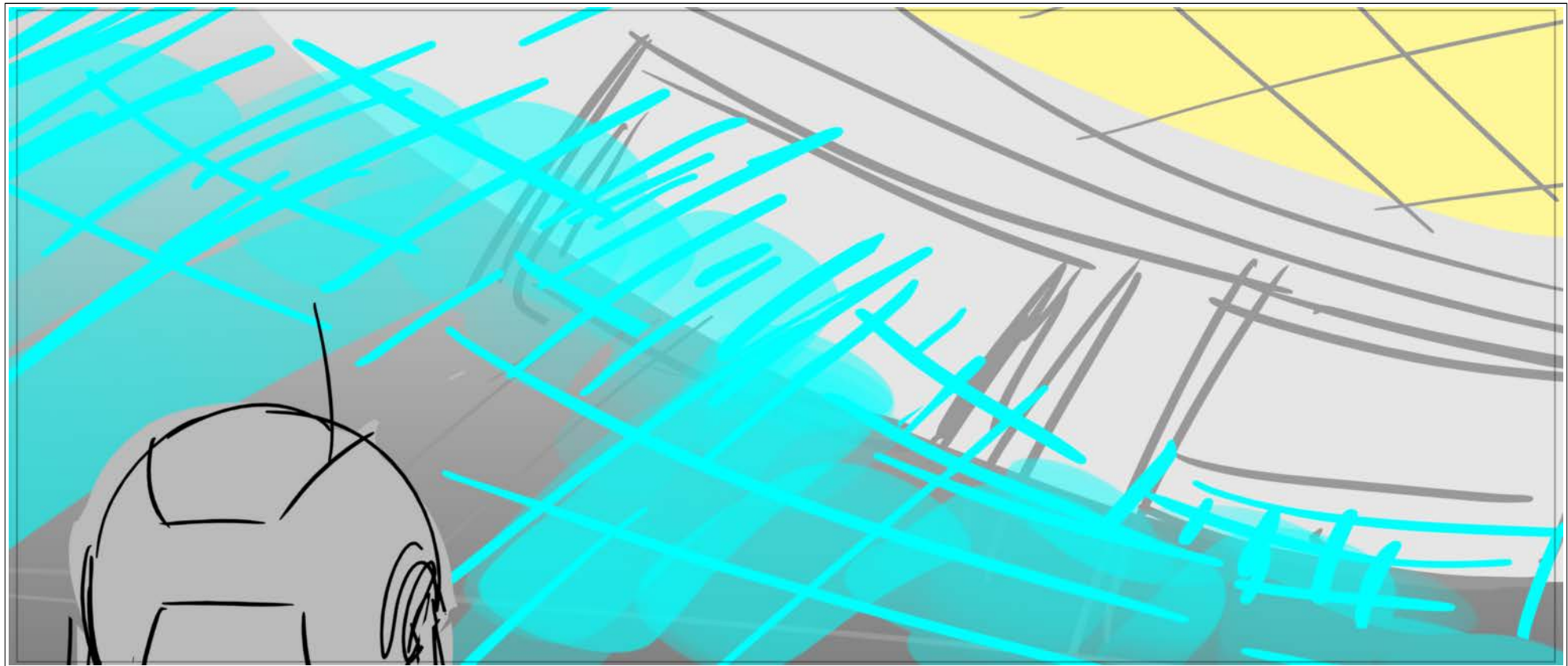

Scene	Duration	Panel	Duration
120	12:00	001E	00:12

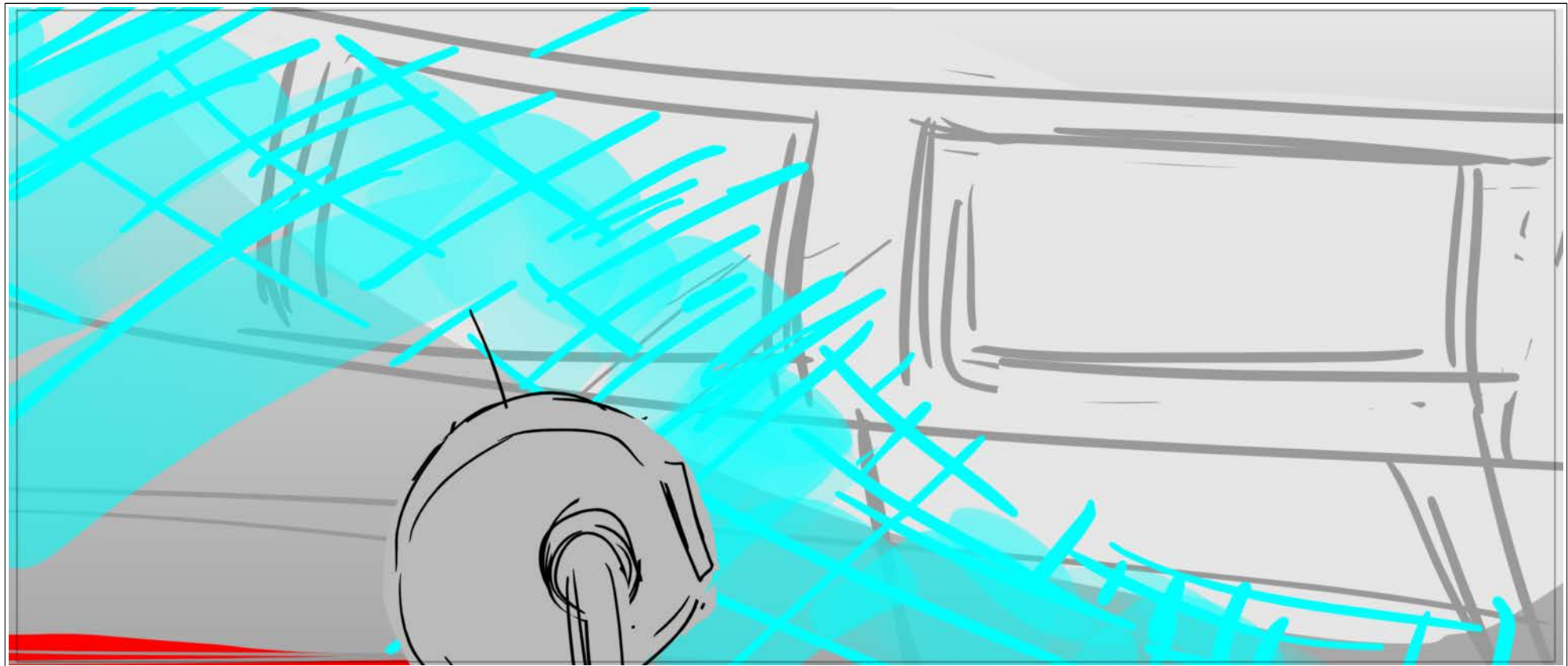

Scene	Duration	Panel	Duration
120	12:00	001B	01:00

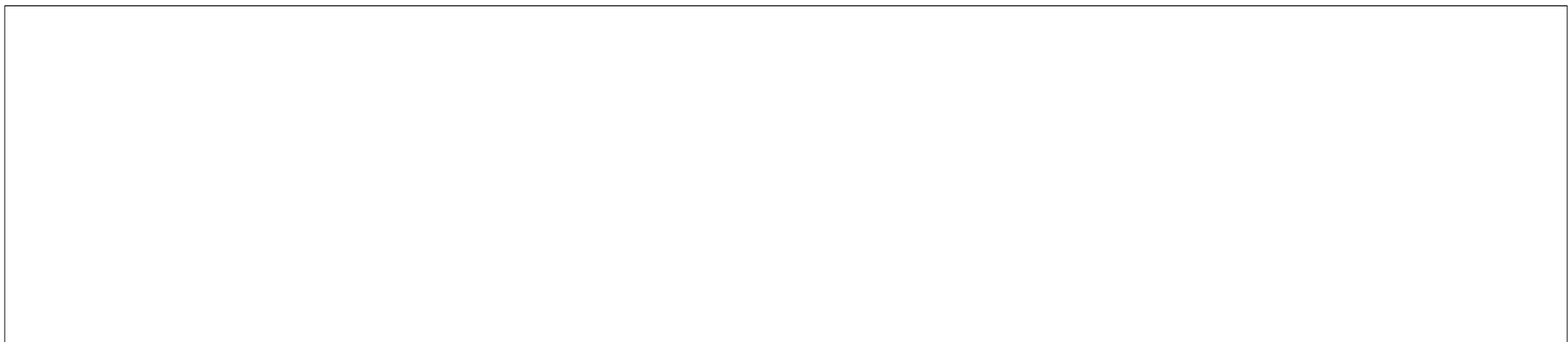
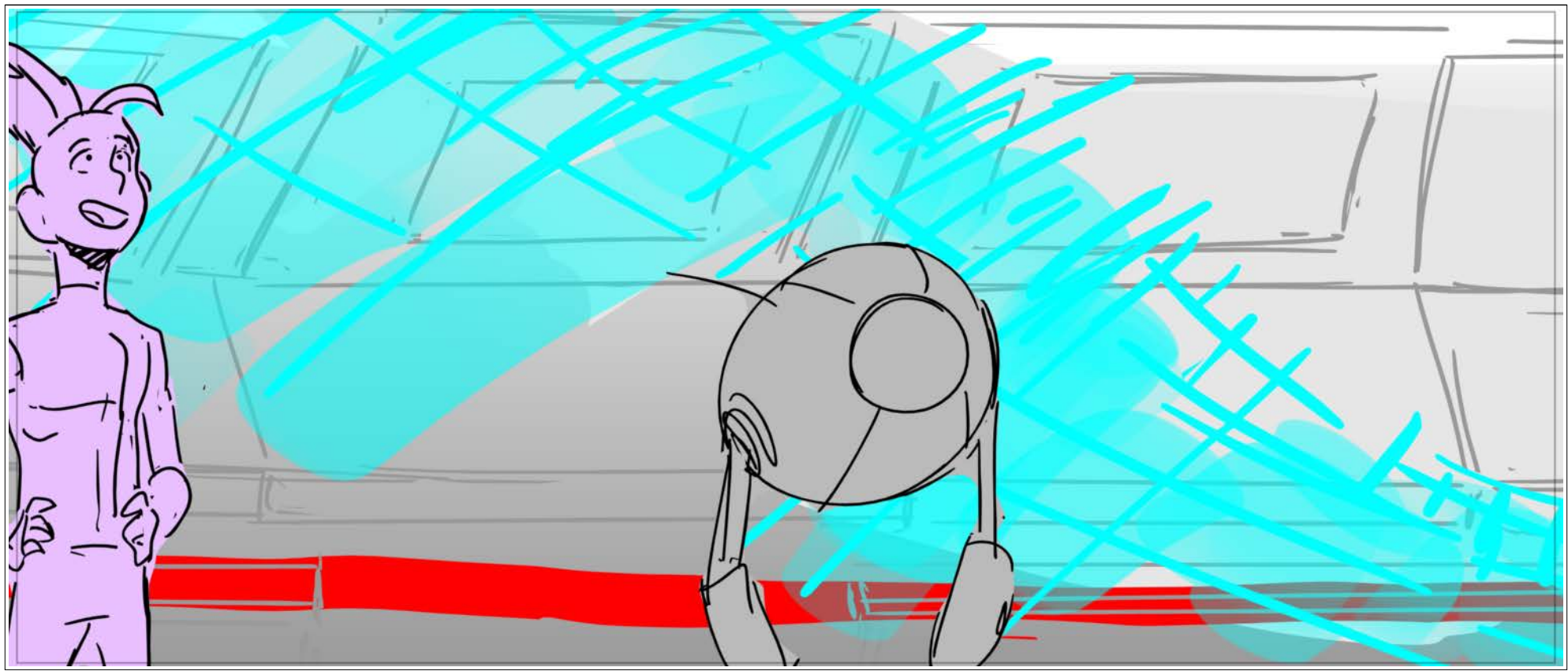

Scene	Duration	Panel	Duration
120	12:00	001F	01:00

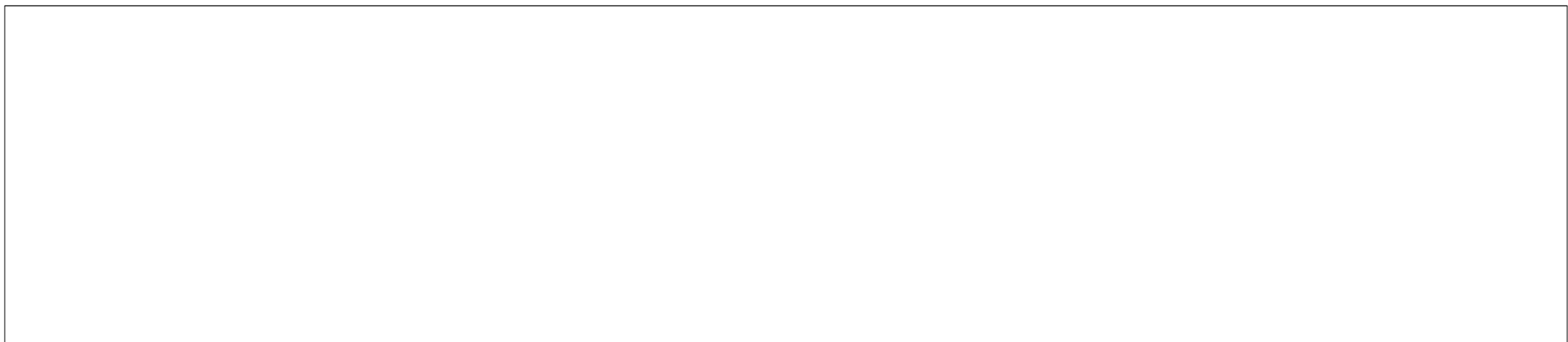
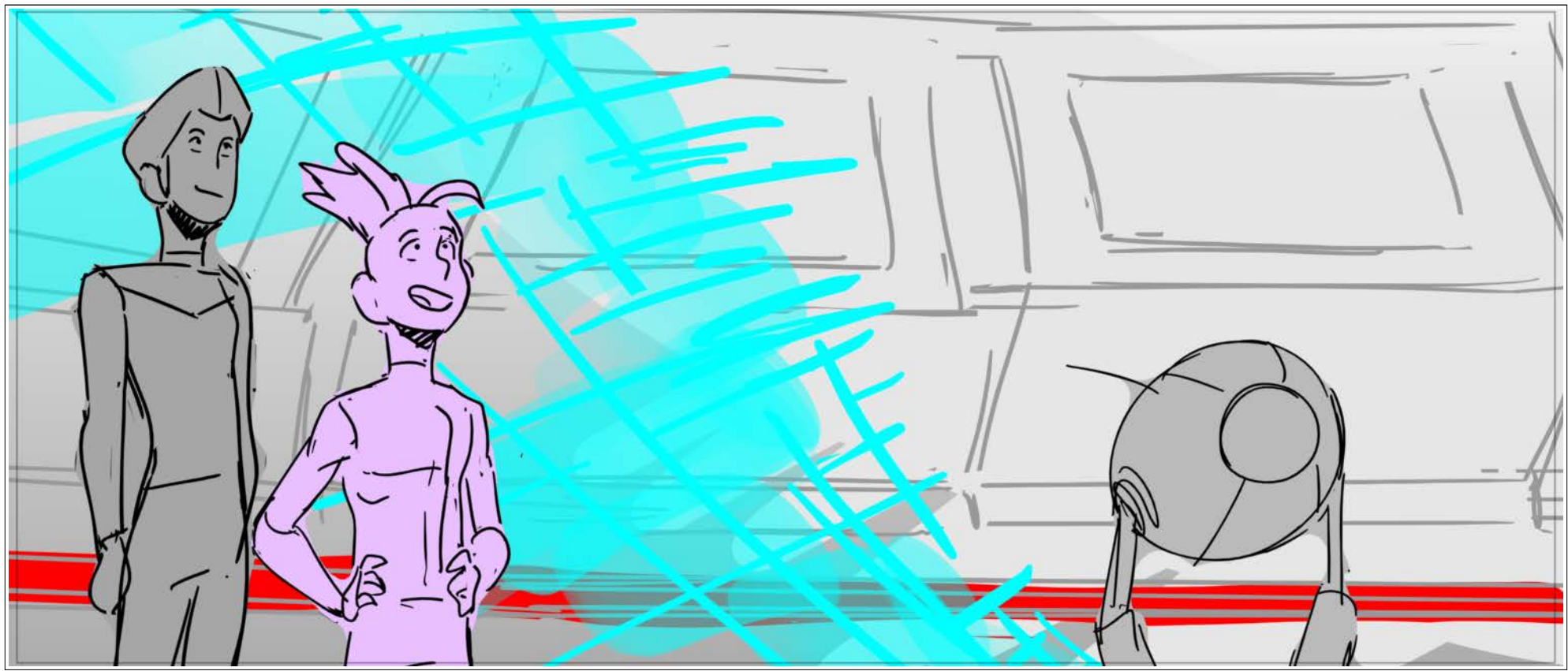

Scene	Duration	Panel	Duration
120	12:00	001H	01:00

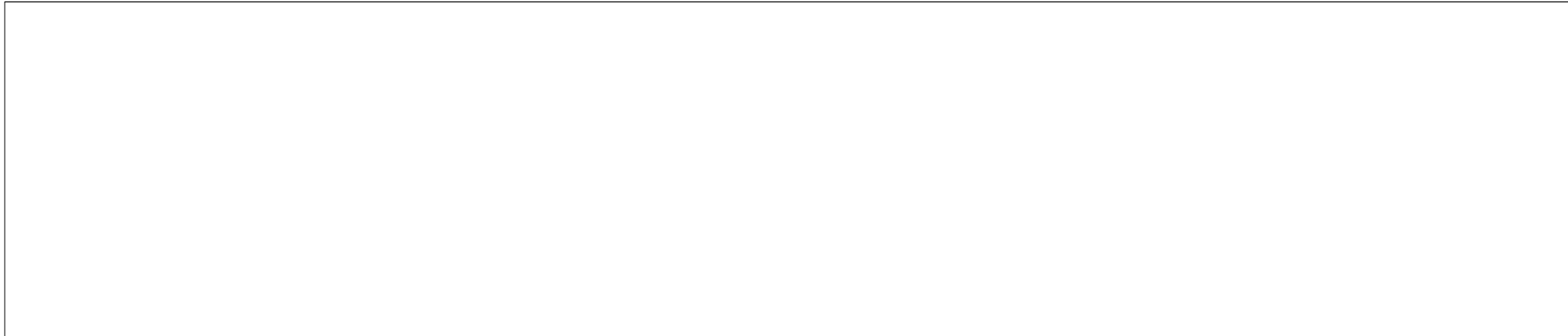

Scene	Duration	Panel	Duration
120	12:00	001C	01:00

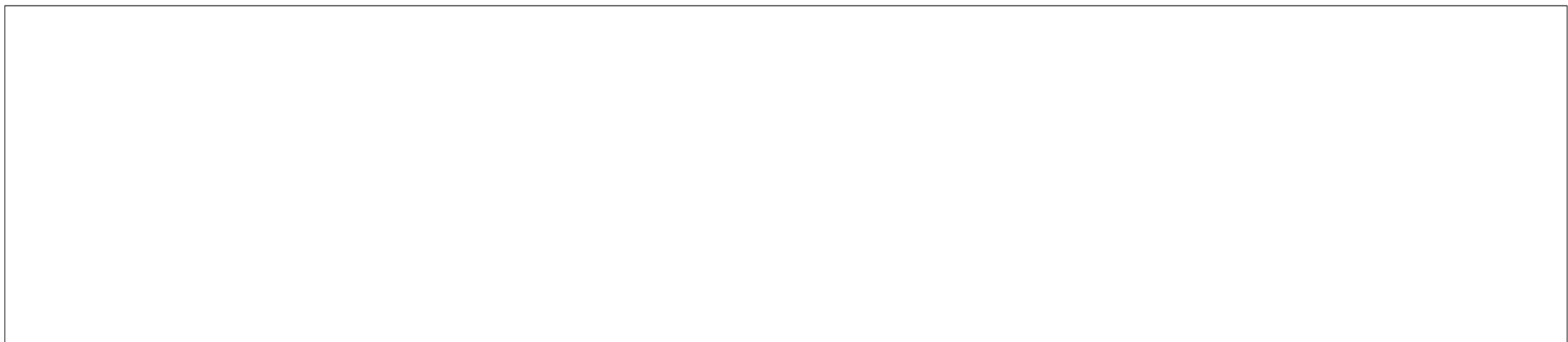
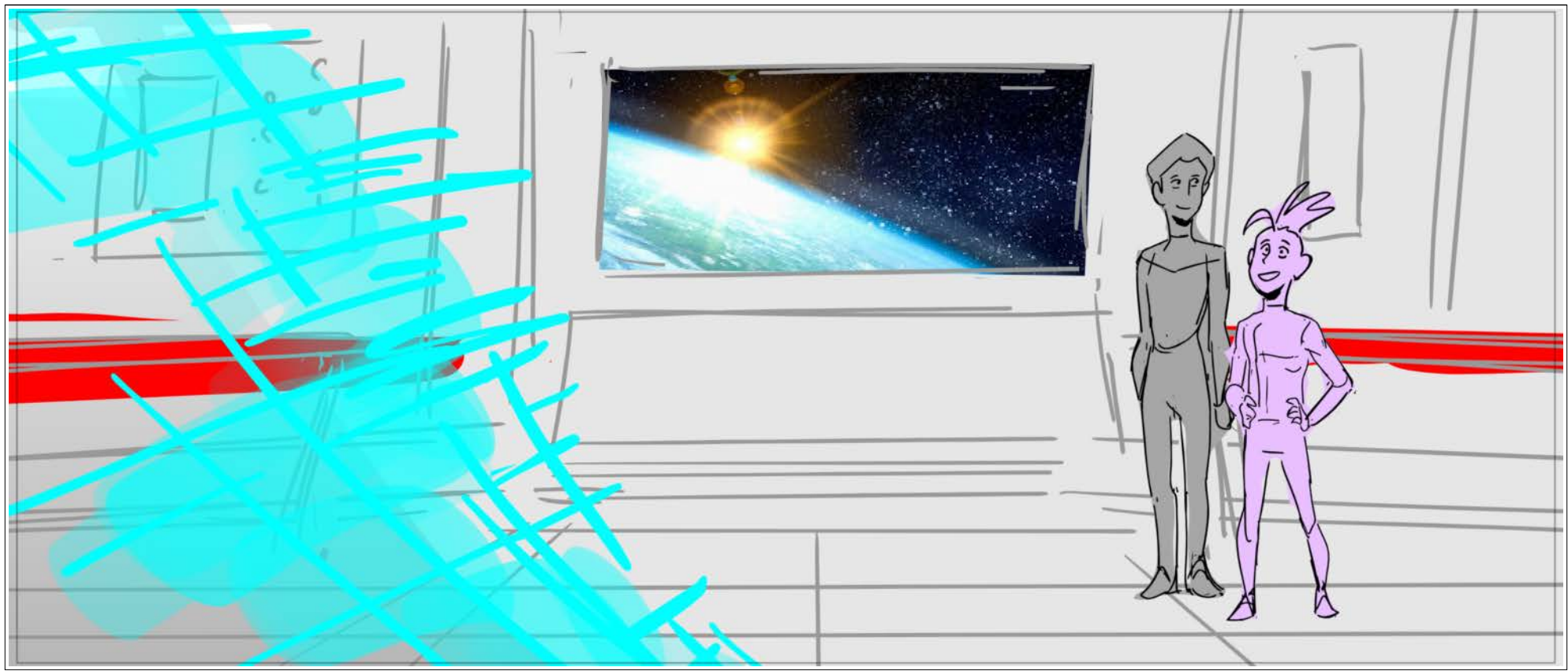

Scene	Duration	Panel	Duration
120	12:00	001G	01:00

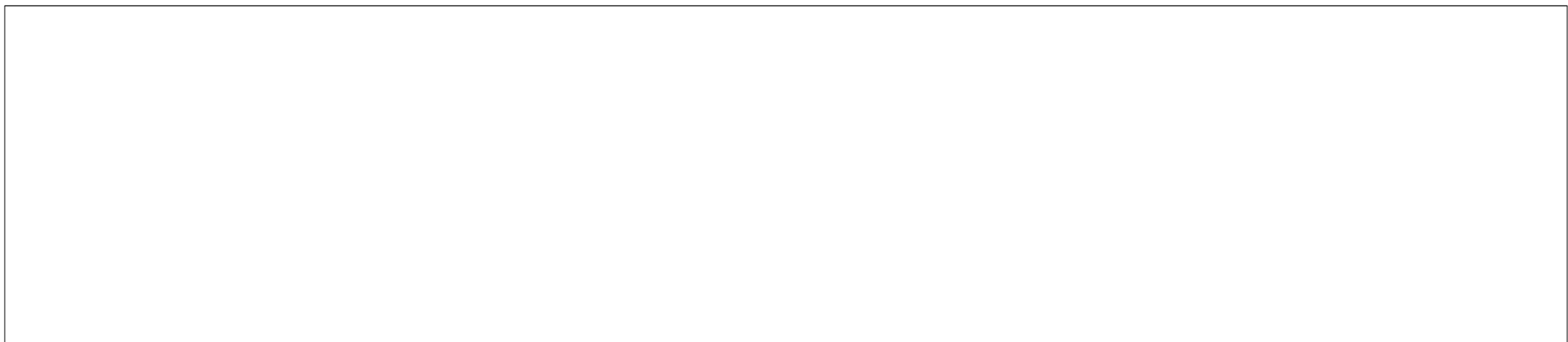
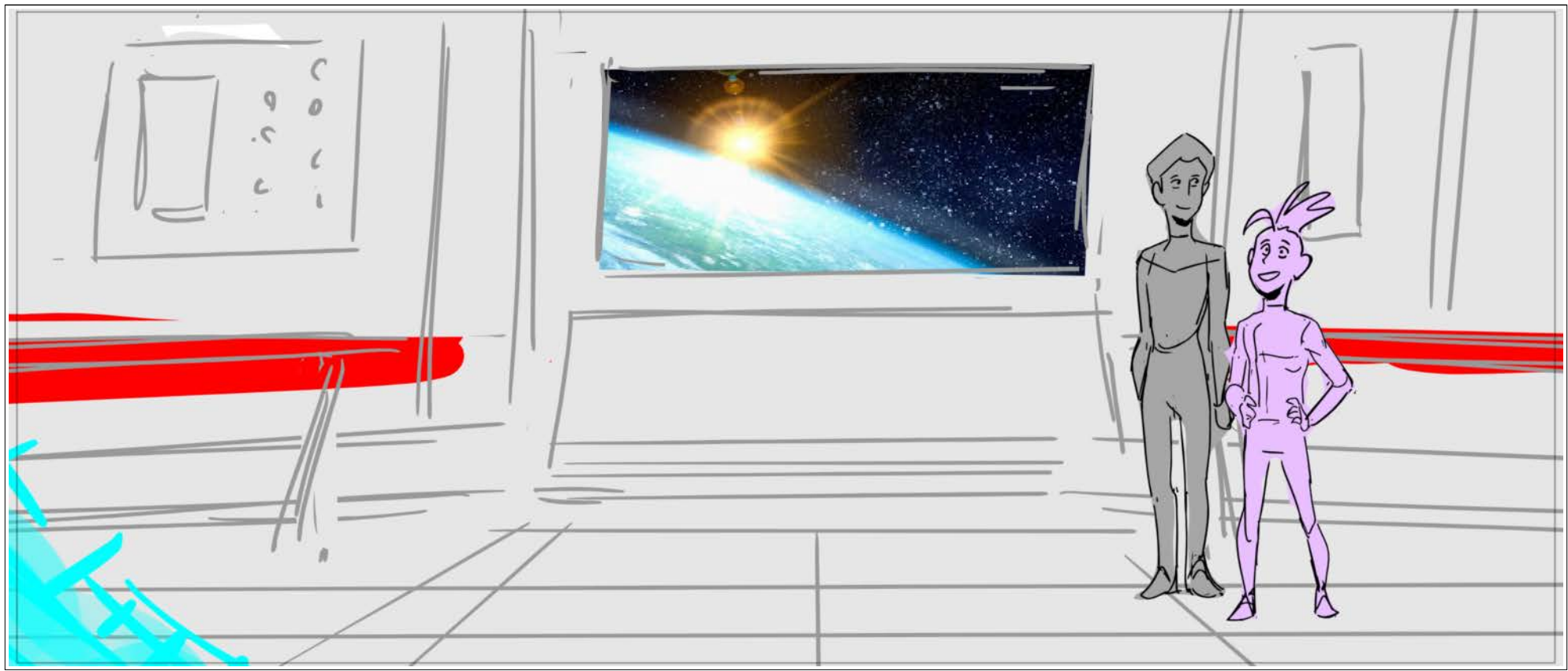

Scene	Duration	Panel	Duration
120	12:00	001I	01:00

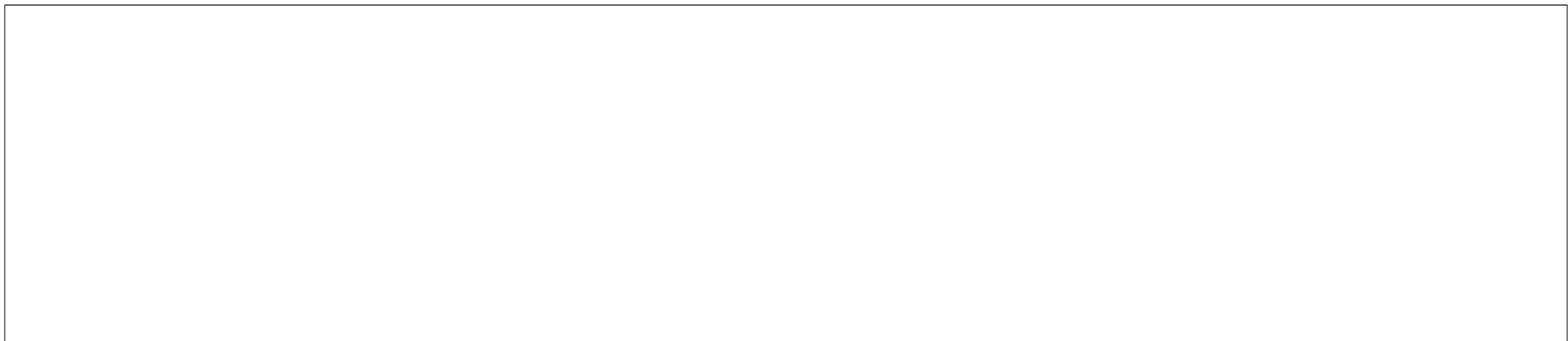
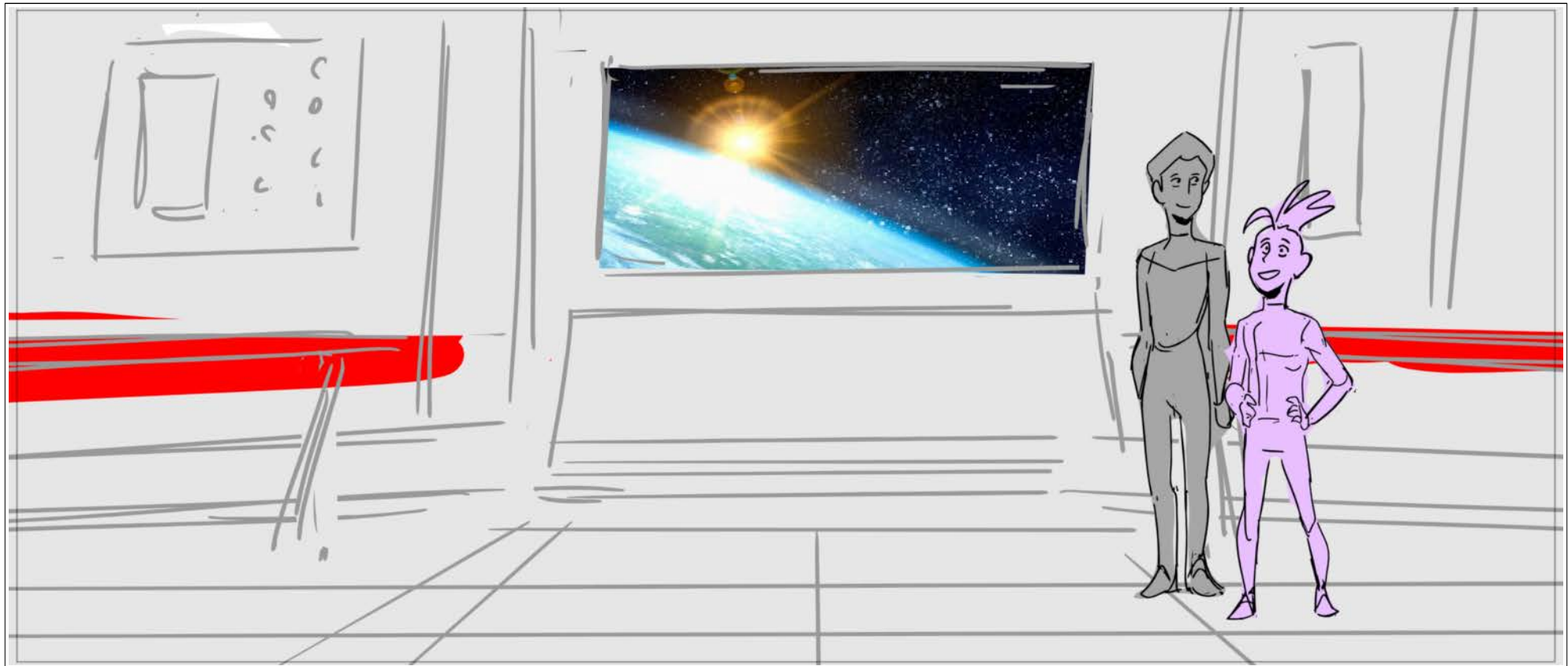

Scene	Duration	Panel	Duration
125	02:12	001E_1	00:12

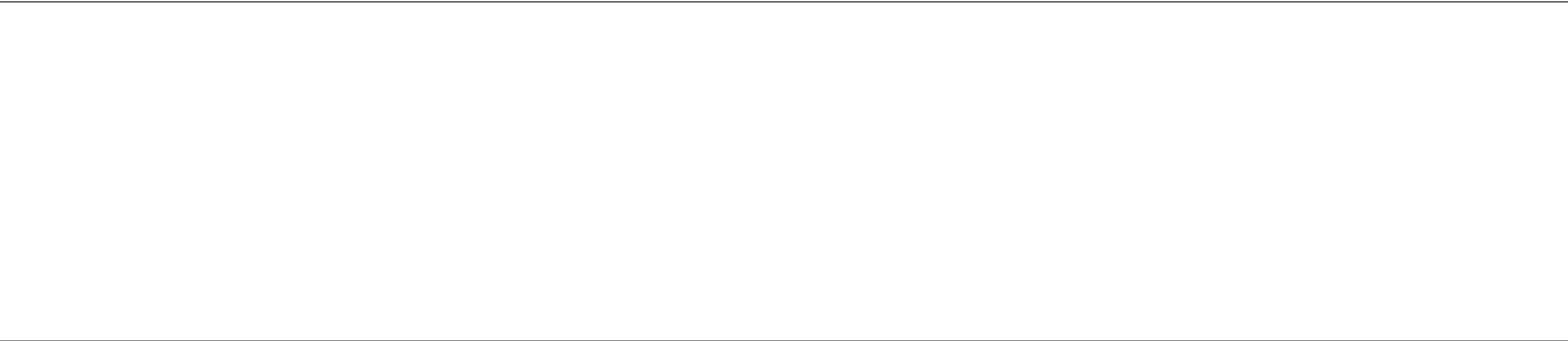
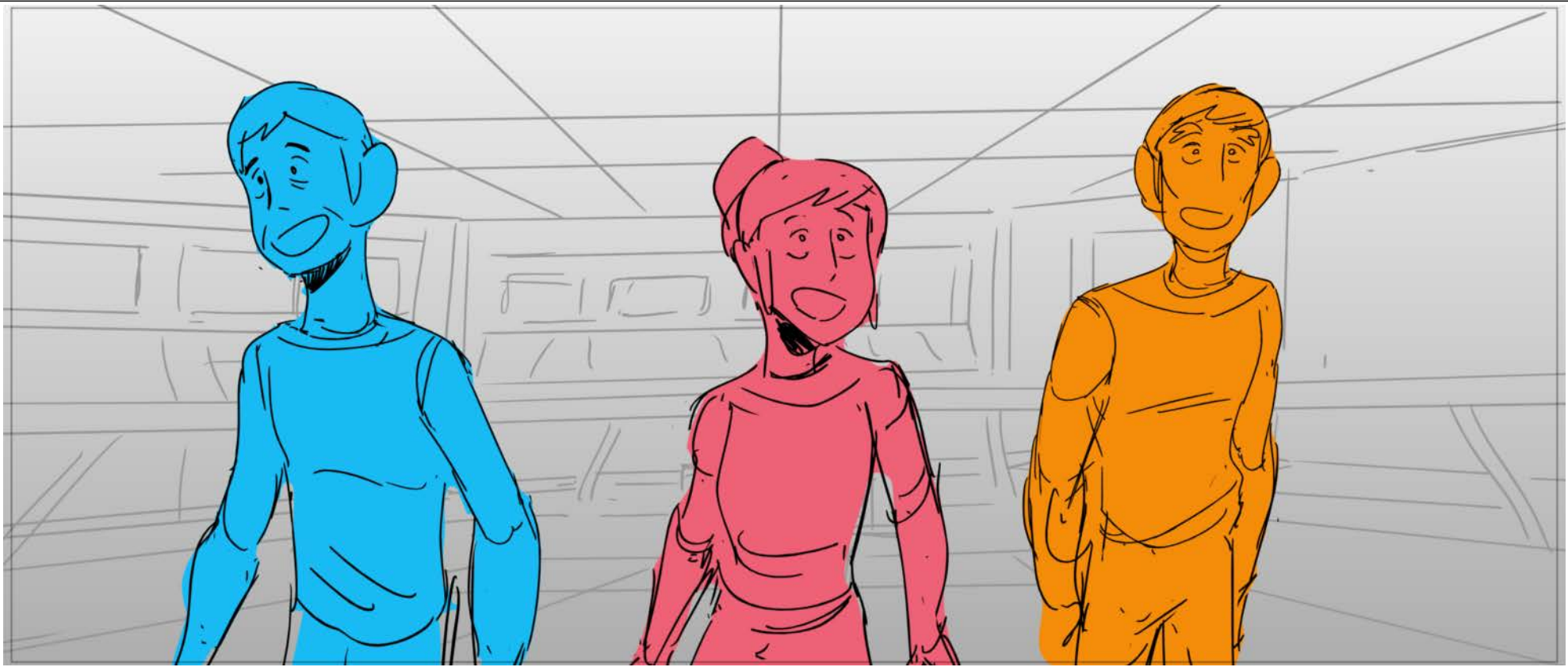

Scene	Duration	Panel	Duration
125	02:12	02F_1	00:09

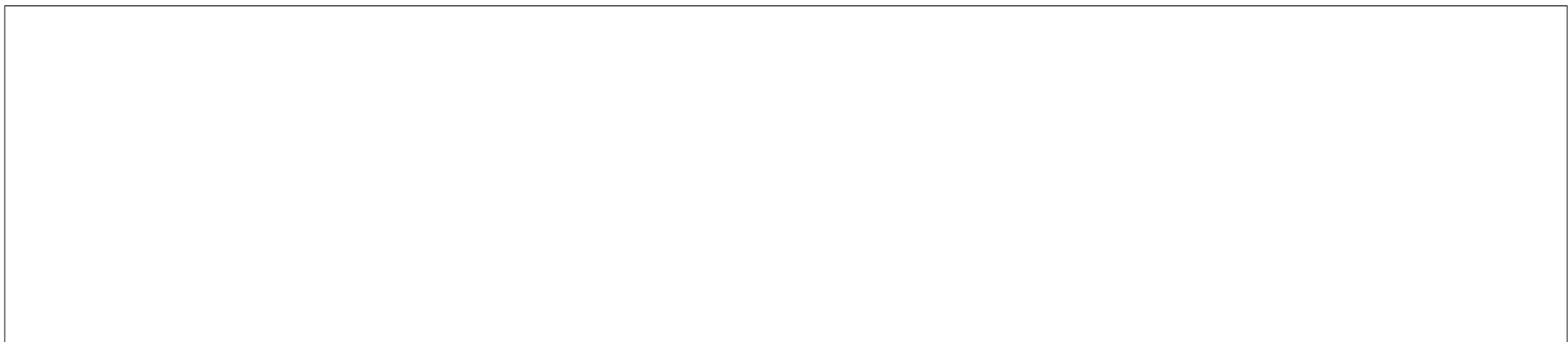

Scene	Duration	Panel	Duration
125	02:12	02F_1_A	00:07

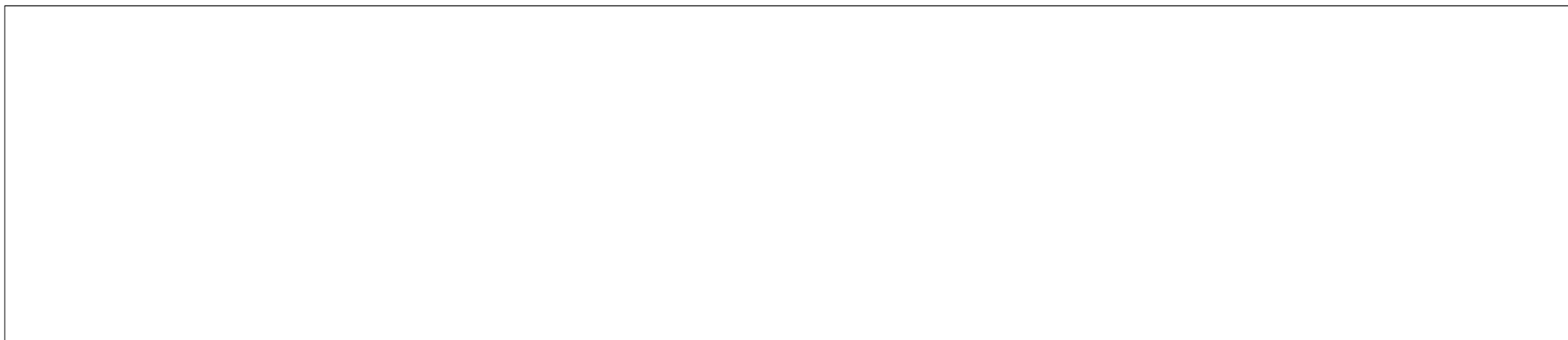

Scene	Duration	Panel	Duration
125	02:12	02F_1_A_1	00:08

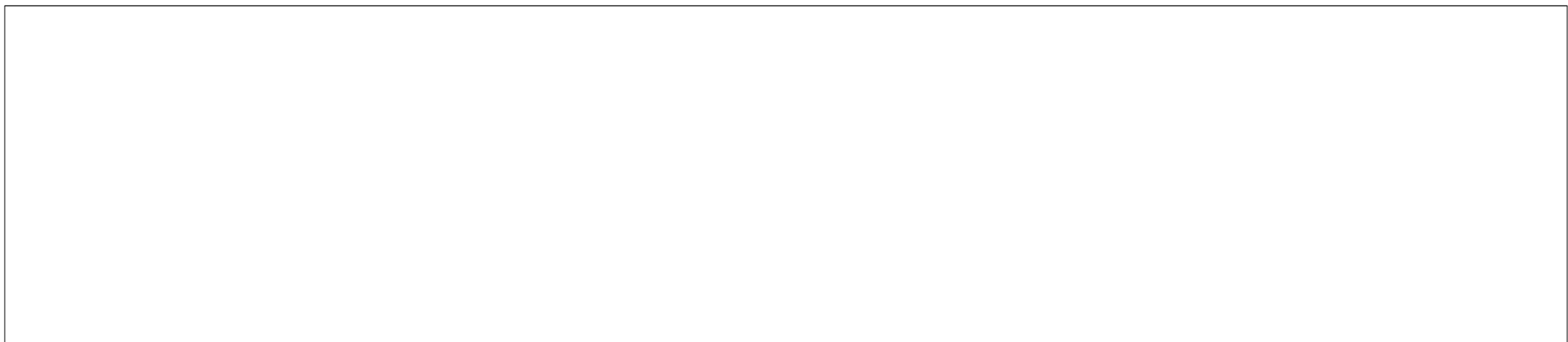

Scene	Duration	Panel	Duration
125	02:12	02F	01:00

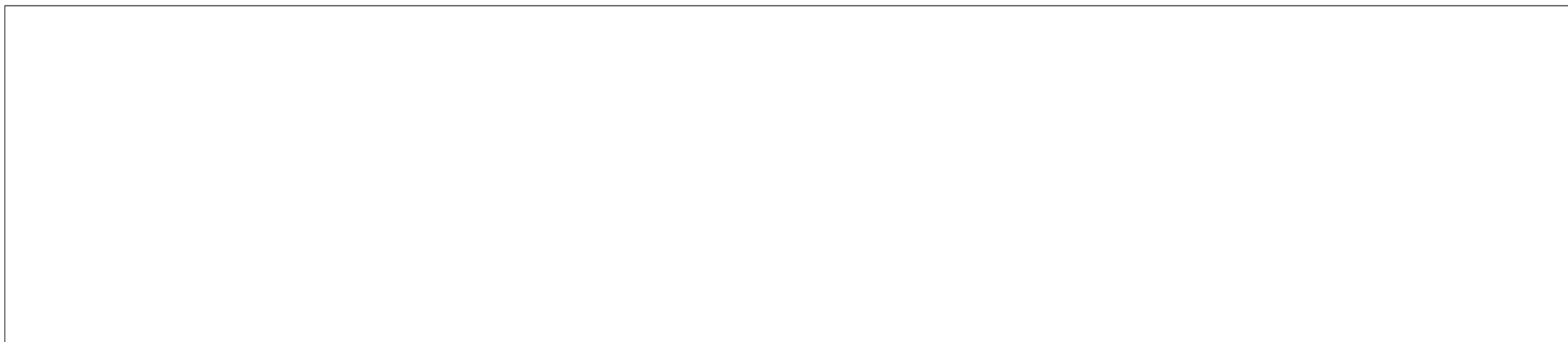

Scene	Duration	Panel	Duration
130	10:00	001	01:00

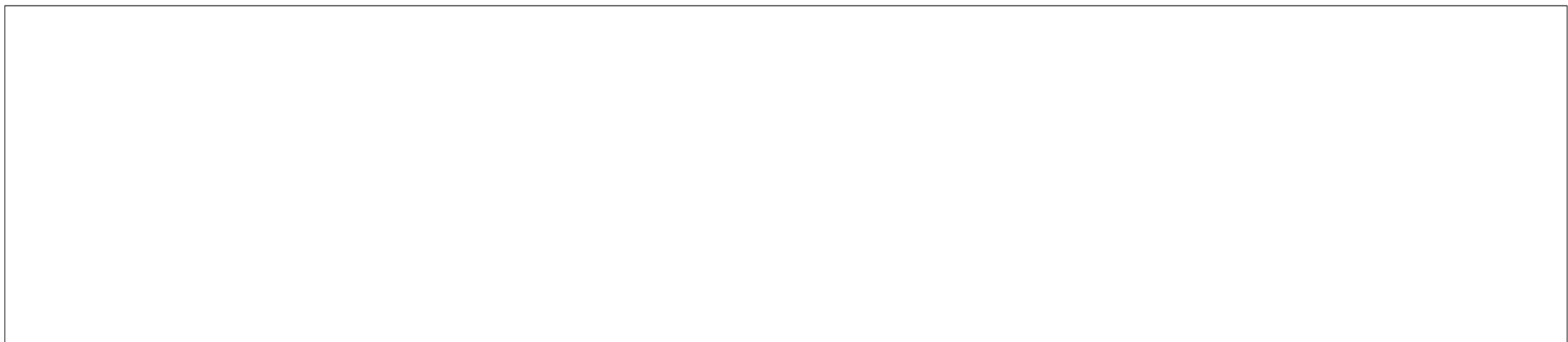
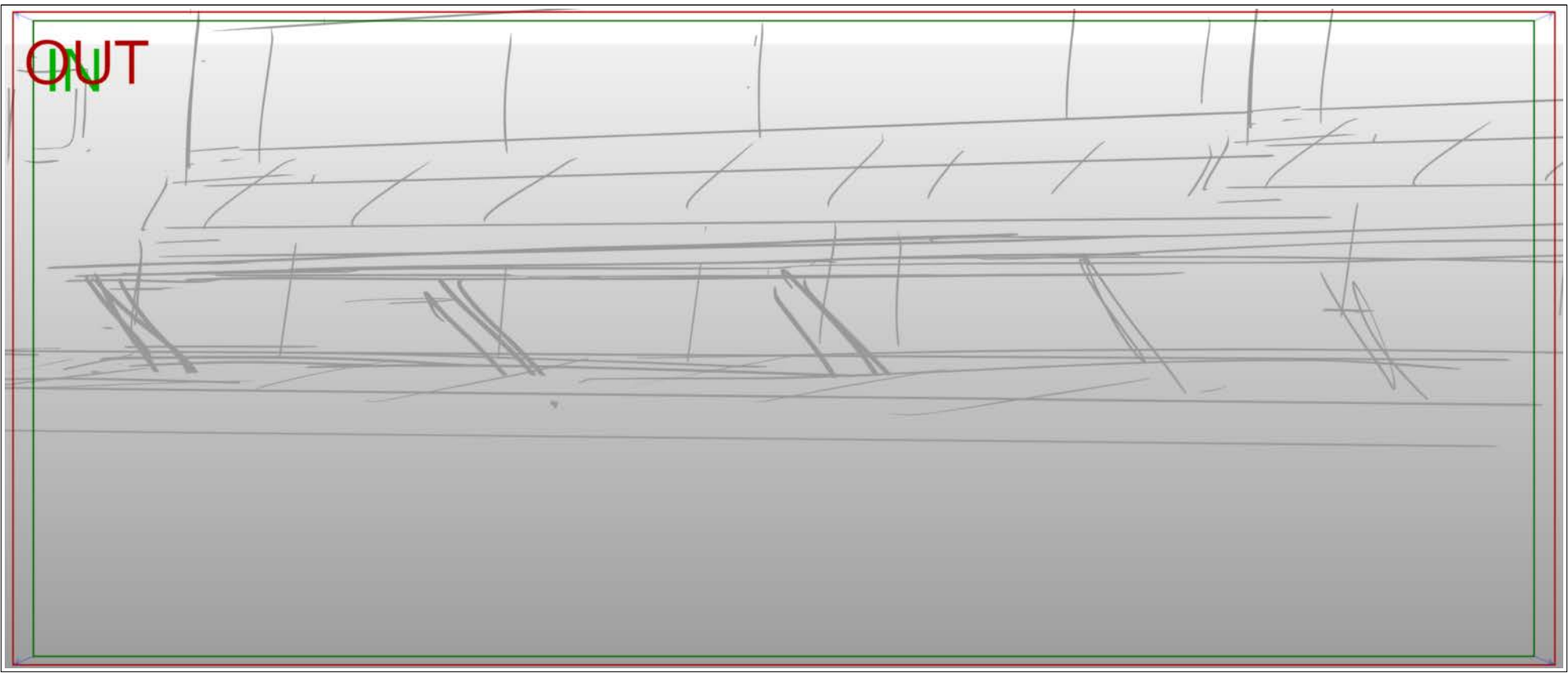

Scene	Duration	Panel	Duration
130	10:00	001A998	01:00

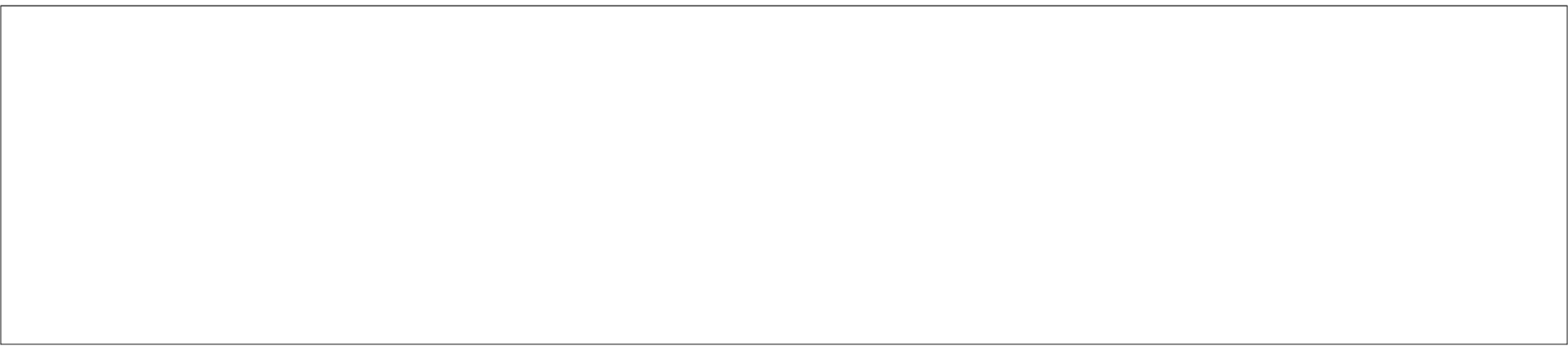
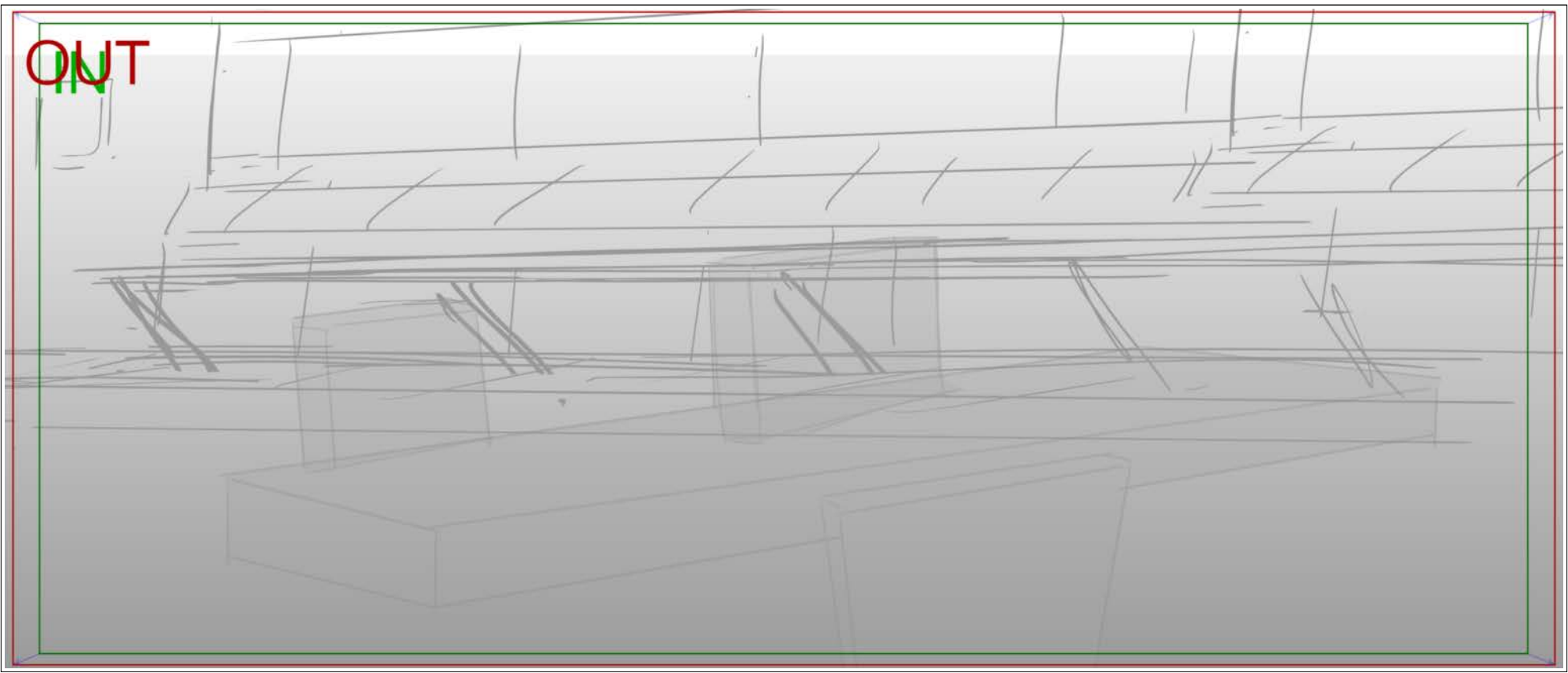

Scene	Duration	Panel	Duration
130	10:00	001A999	01:00

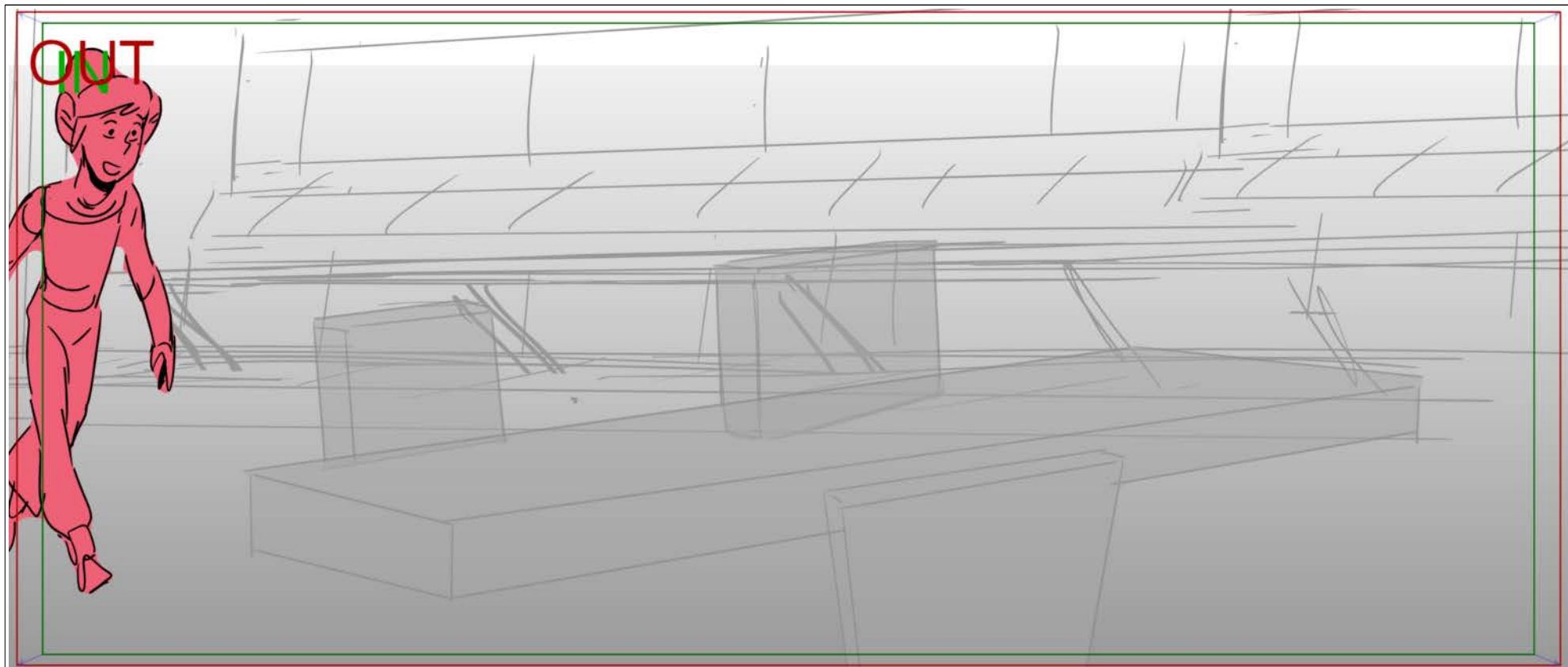

Action Notes

DISPLAY HOLOGRAM APPEARS

Scene	Duration	Panel	Duration
130	10:00	001A0	01:00

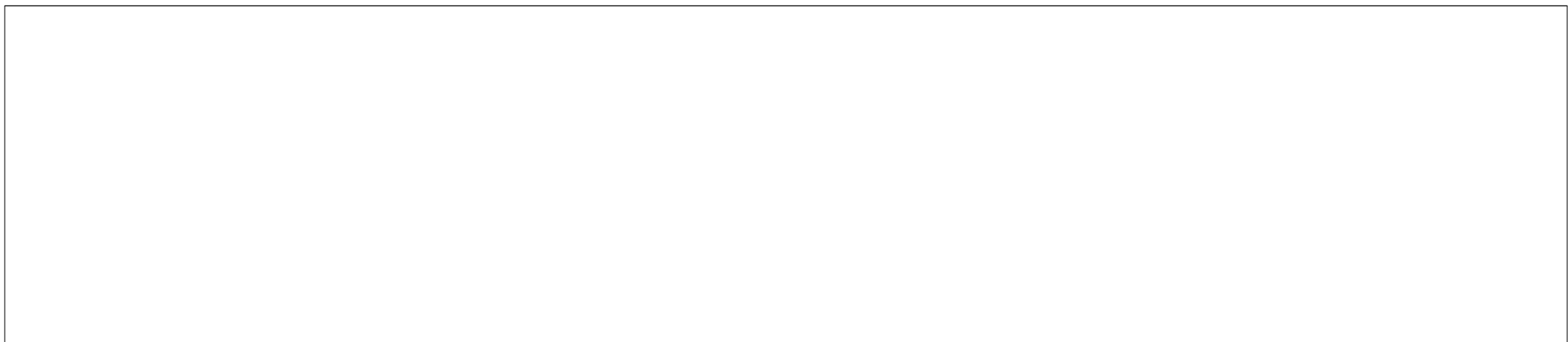
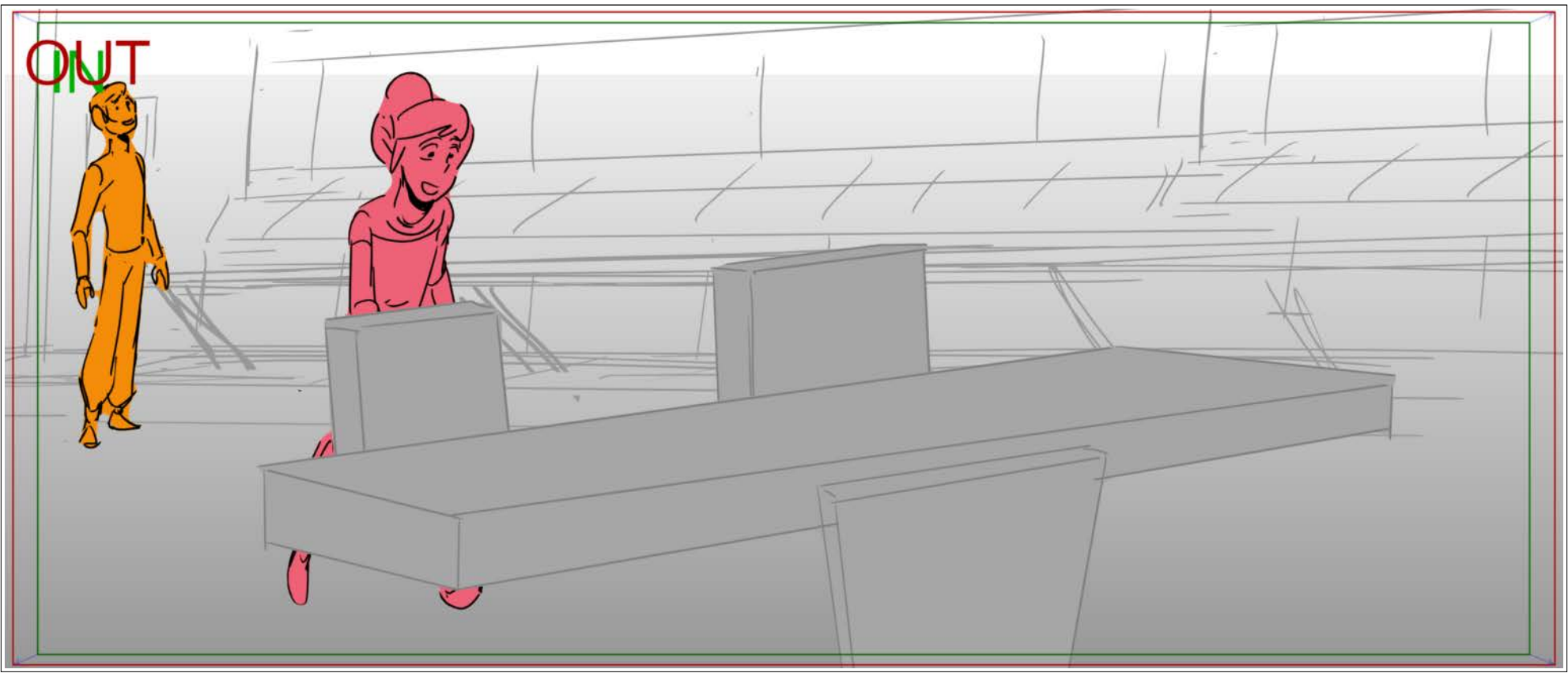

Scene	Duration	Panel	Duration
130	10:00	001A	01:00

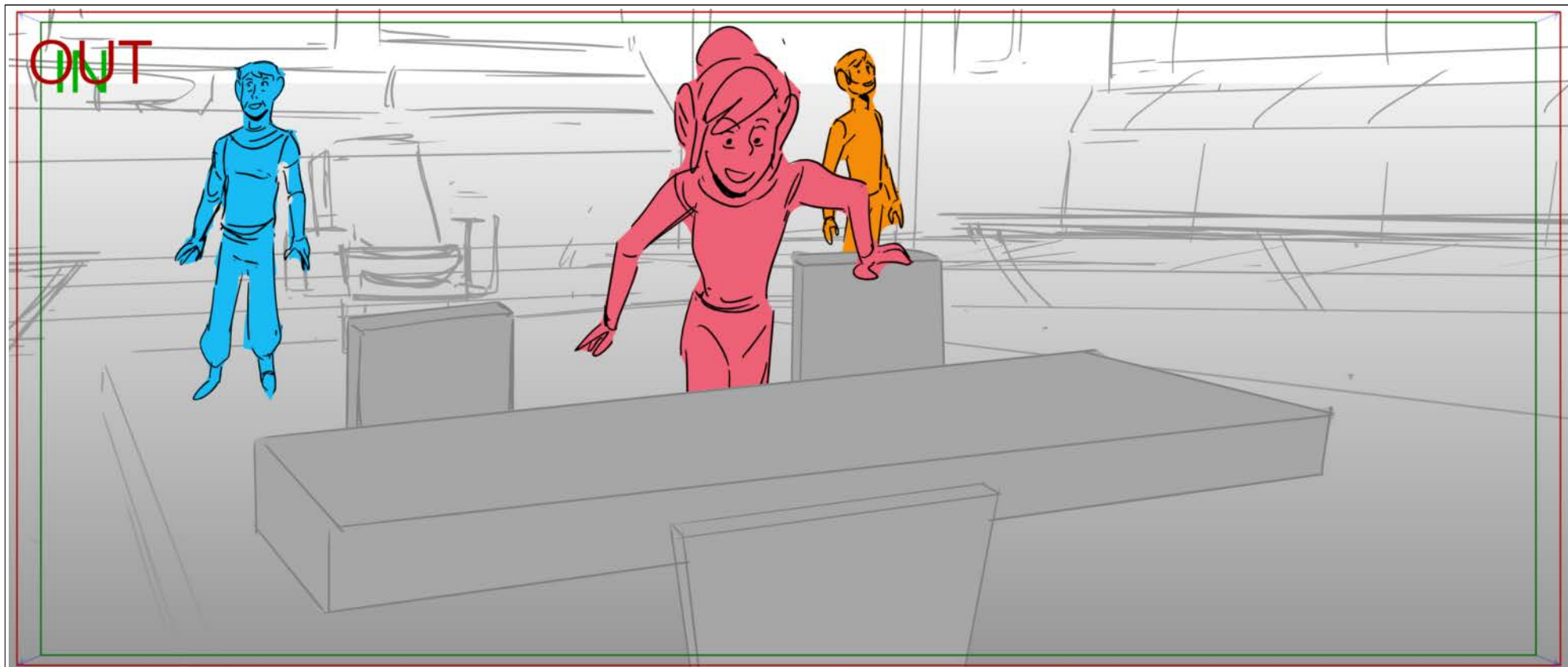

Action Notes

CAMERA TURNS AND ORBITS

Scene	Duration	Panel	Duration
130	10:00	001B	01:00



Dialog

HUUR'A

183 This, I know.

Scene	Duration	Panel	Duration
130	10:00	001C	01:00

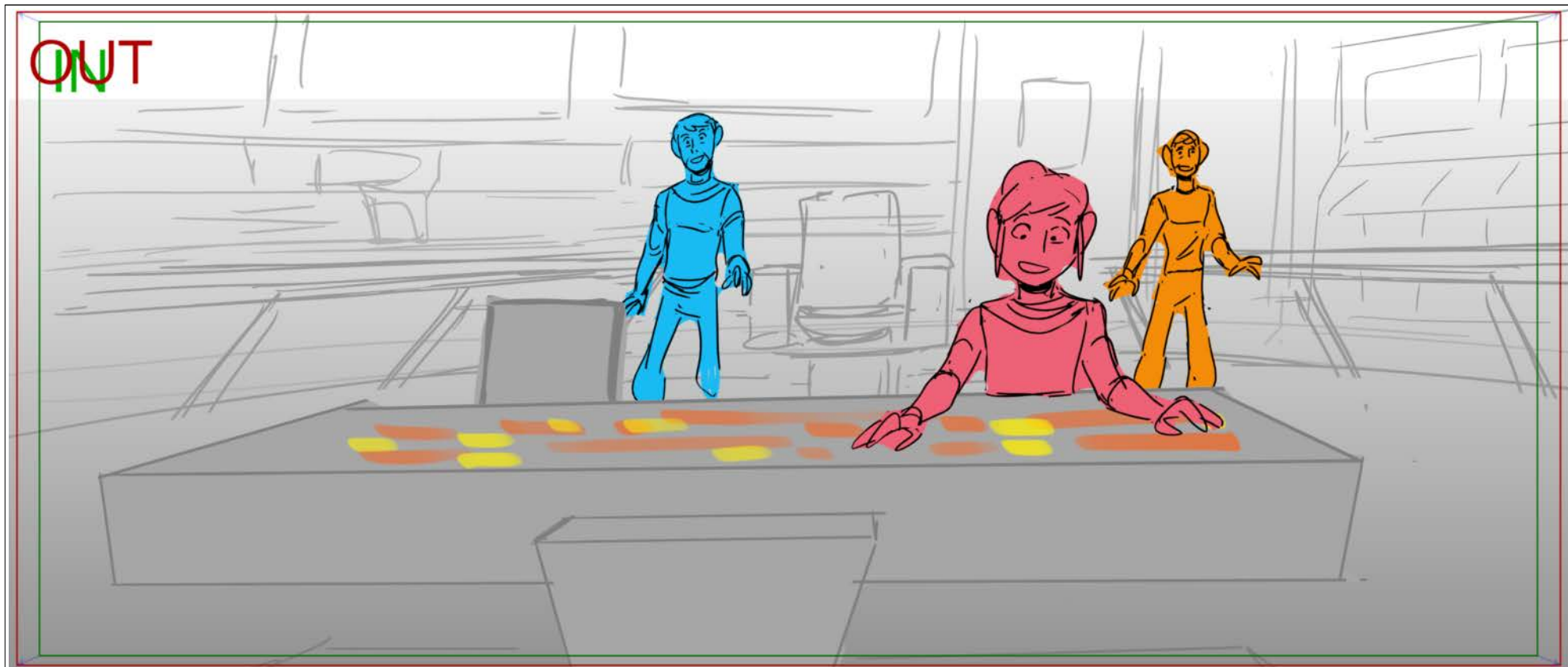

Dialog

HUUR'A

183 This, I know.

Scene	Duration	Panel	Duration
130	10:00	001D	01:00

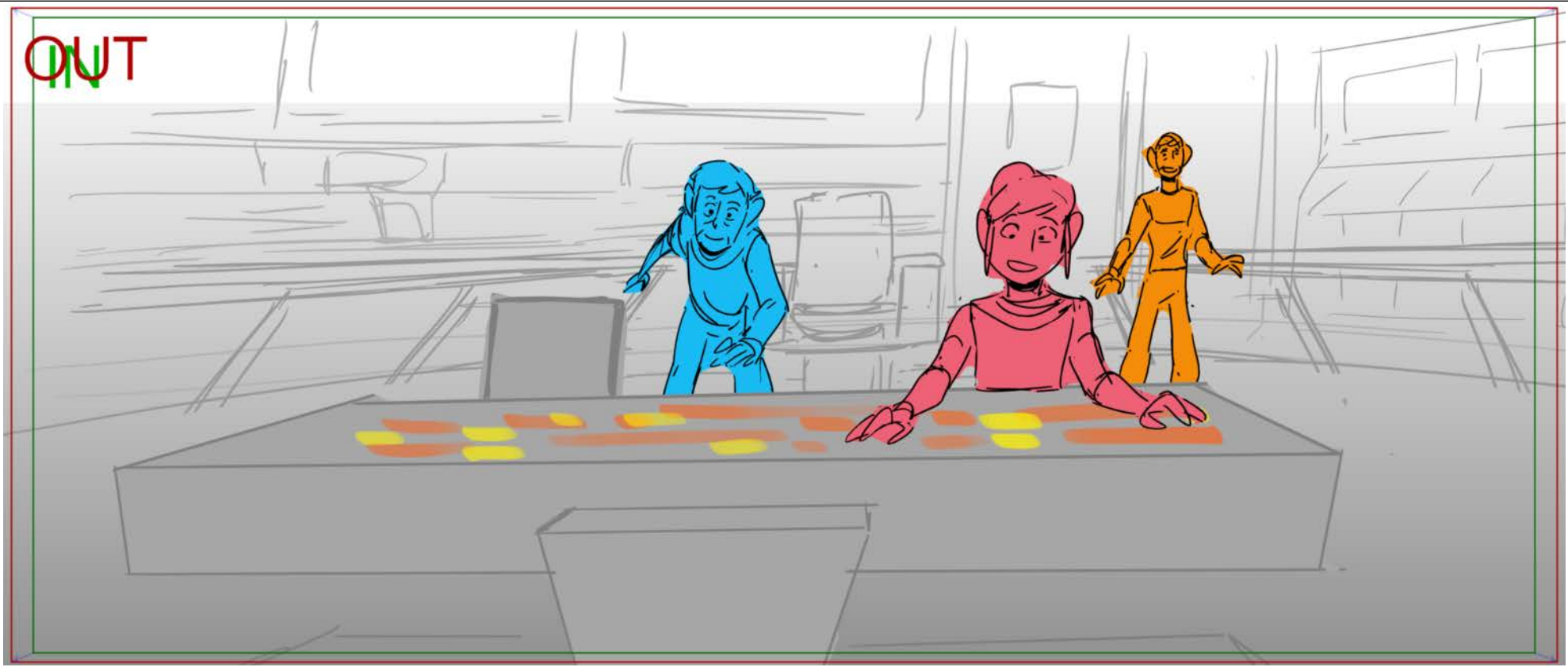

Scene	Duration	Panel	Duration
130	10:00	02D	01:00

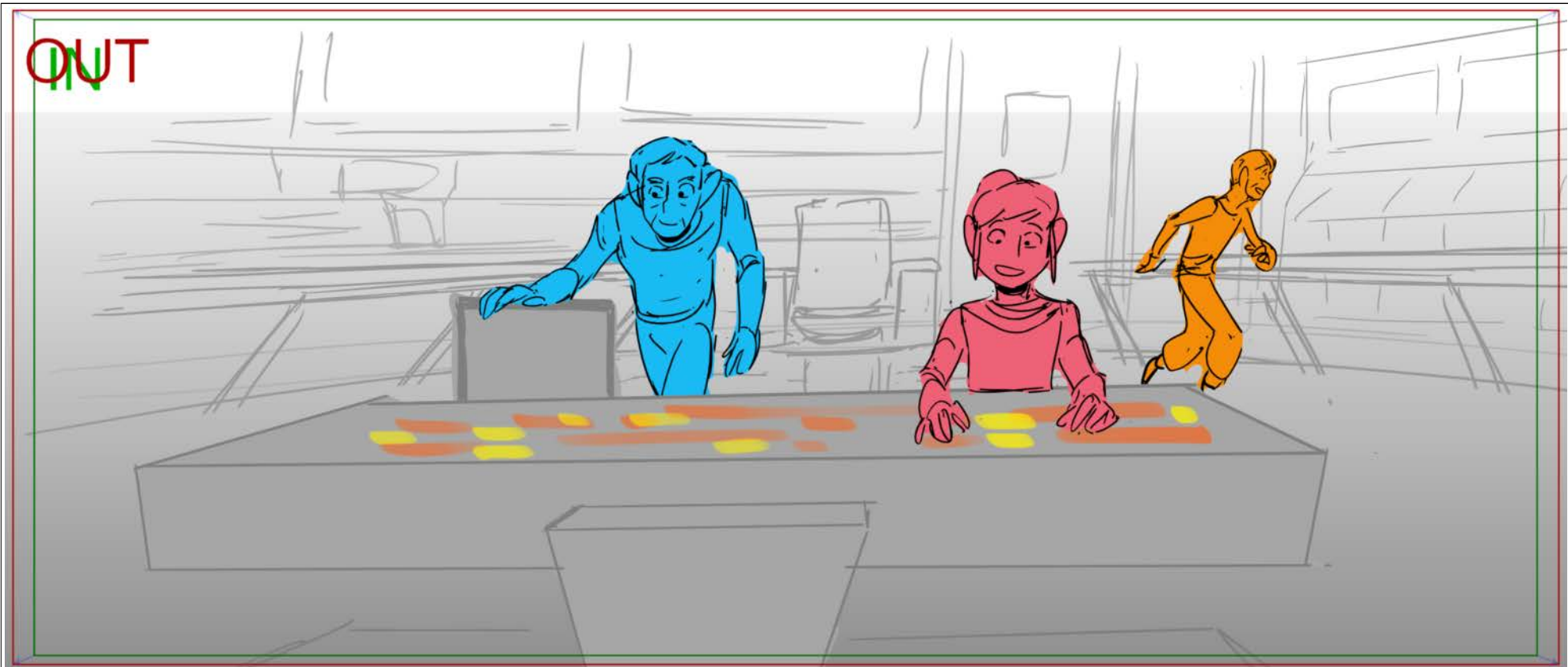

Scene	Duration	Panel	Duration
130	10:00	02E	01:00

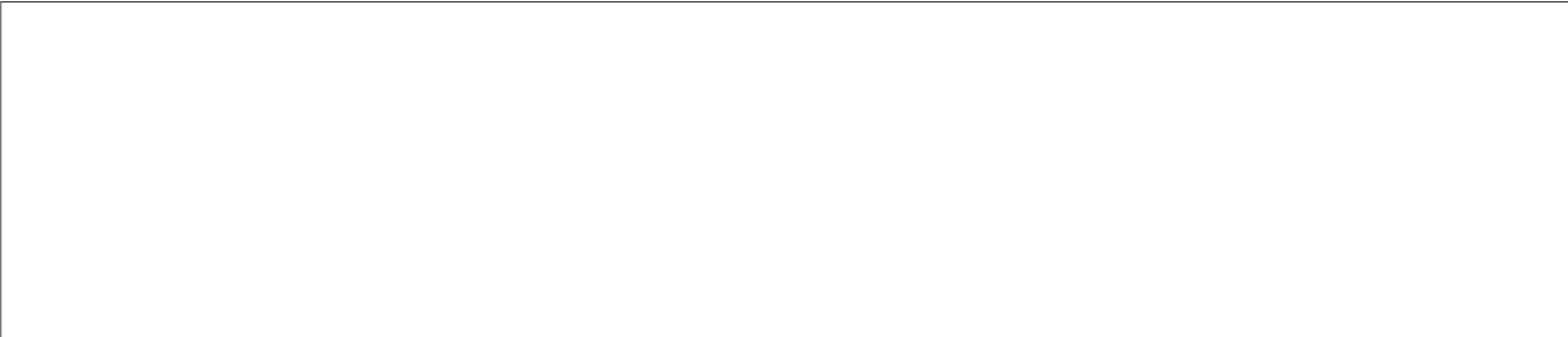
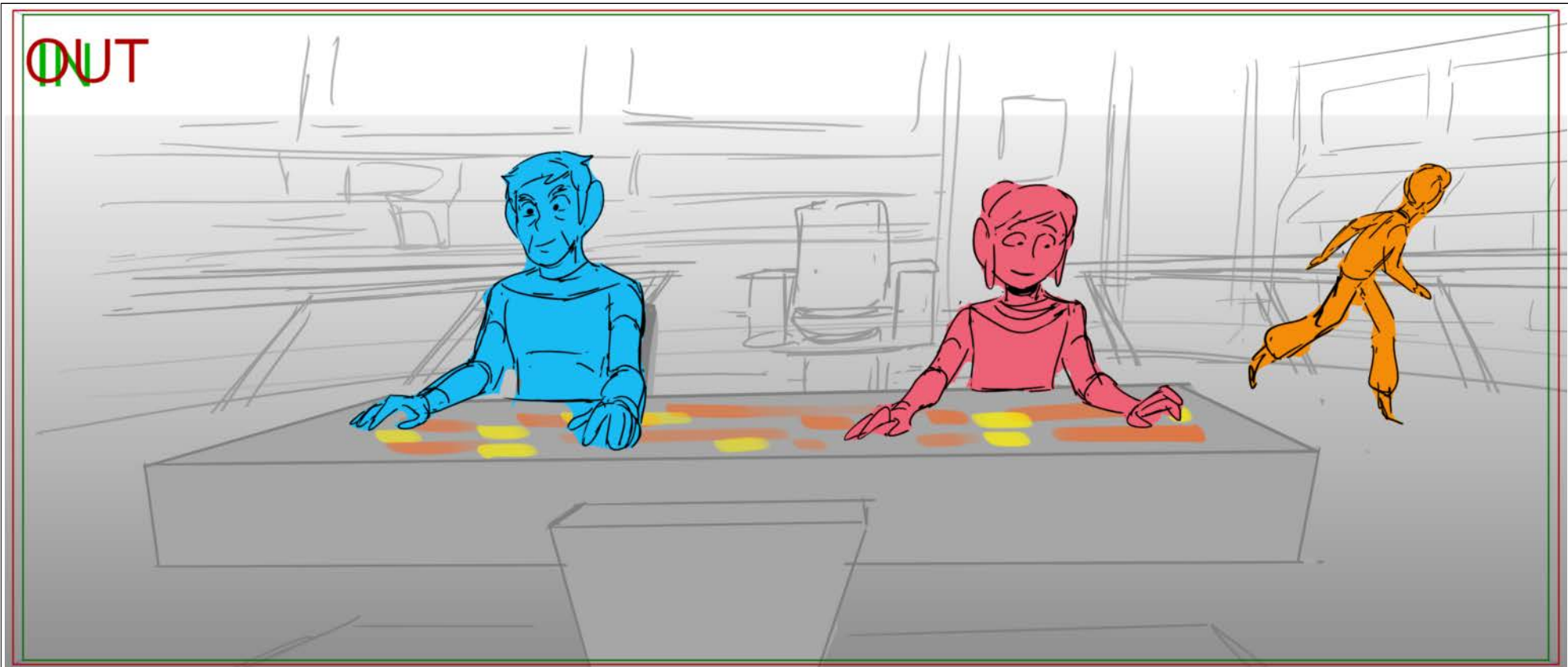

Scene	Duration	Panel	Duration
140	04:00	001	01:00

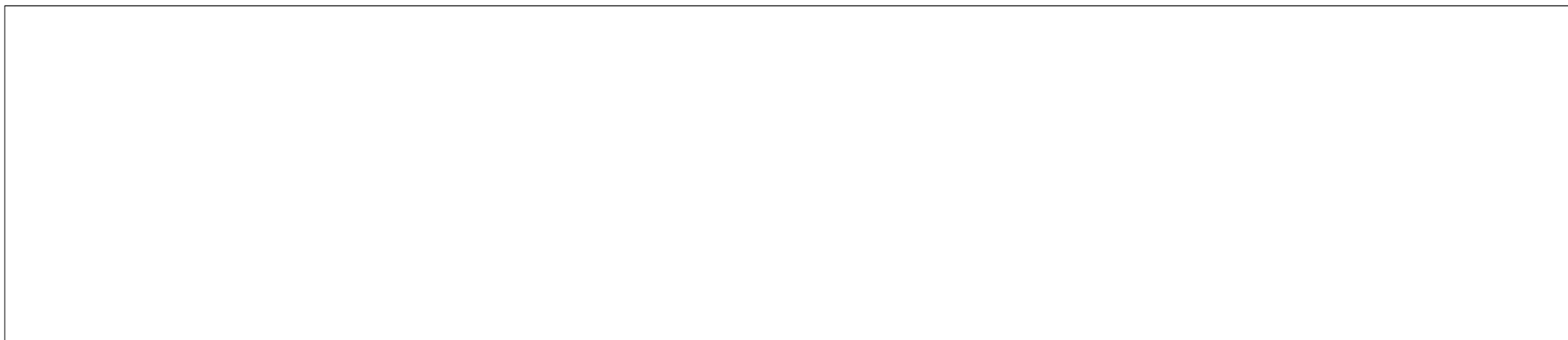
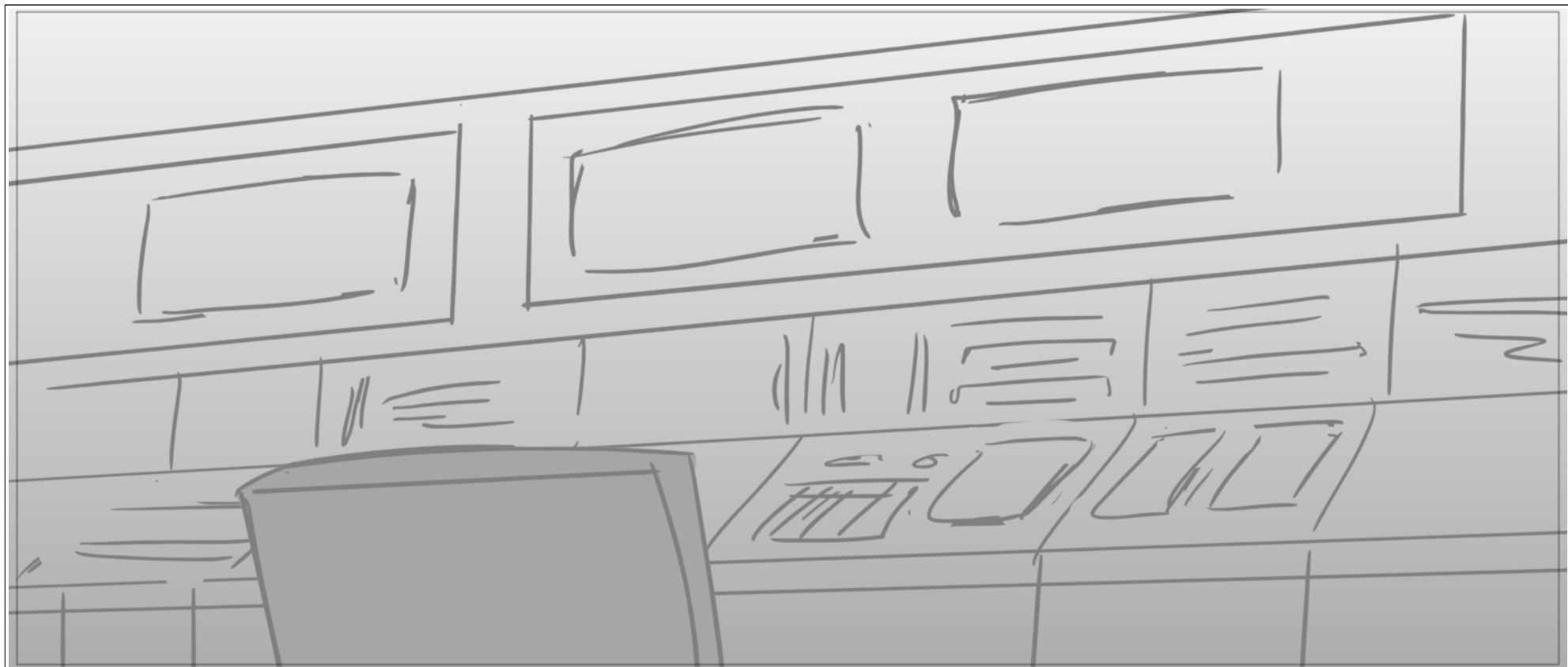

Scene	Duration	Panel	Duration
140	04:00	001A	01:00

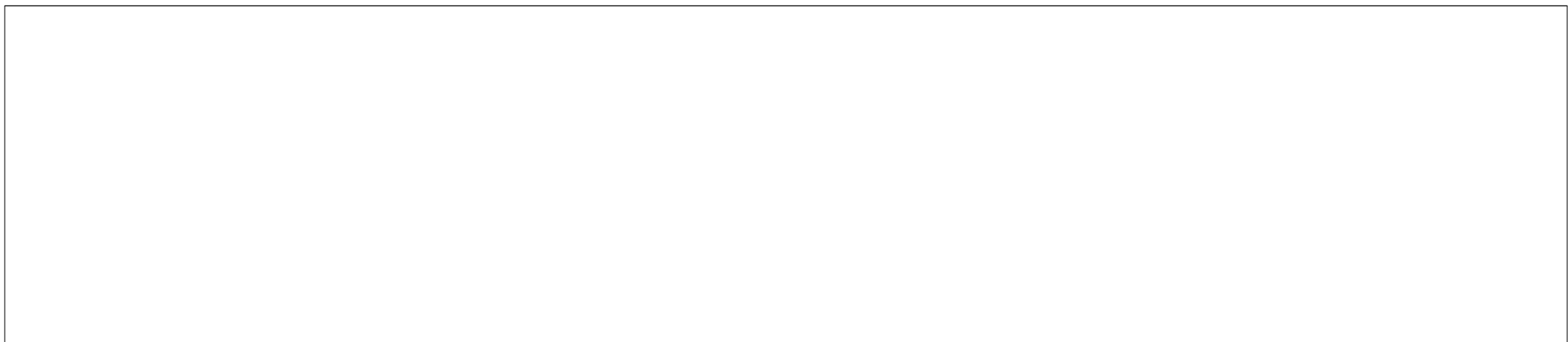

Scene	Duration	Panel	Duration
140	04:00	001B	01:00

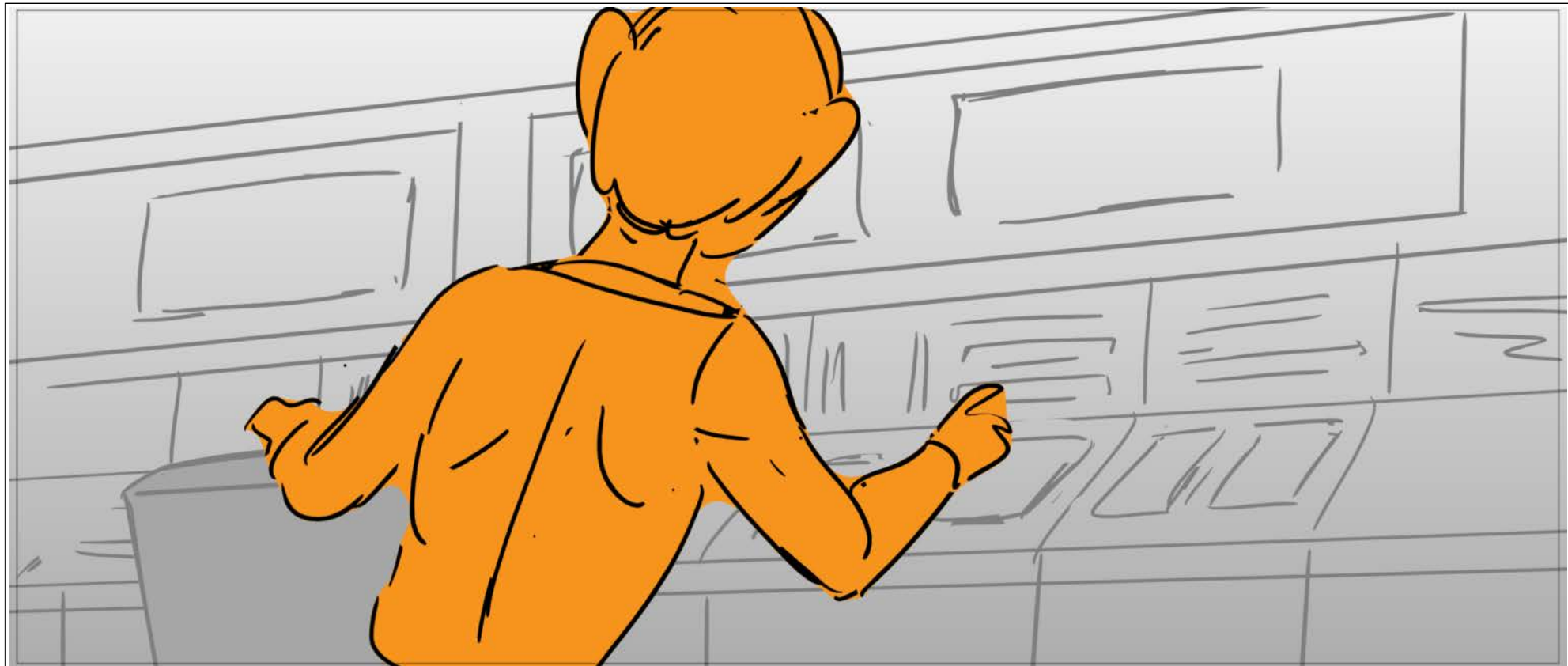

Scene	Duration	Panel	Duration
140	04:00	001C	01:00



Scene	Duration	Panel	Duration
160	04:00	001	01:00

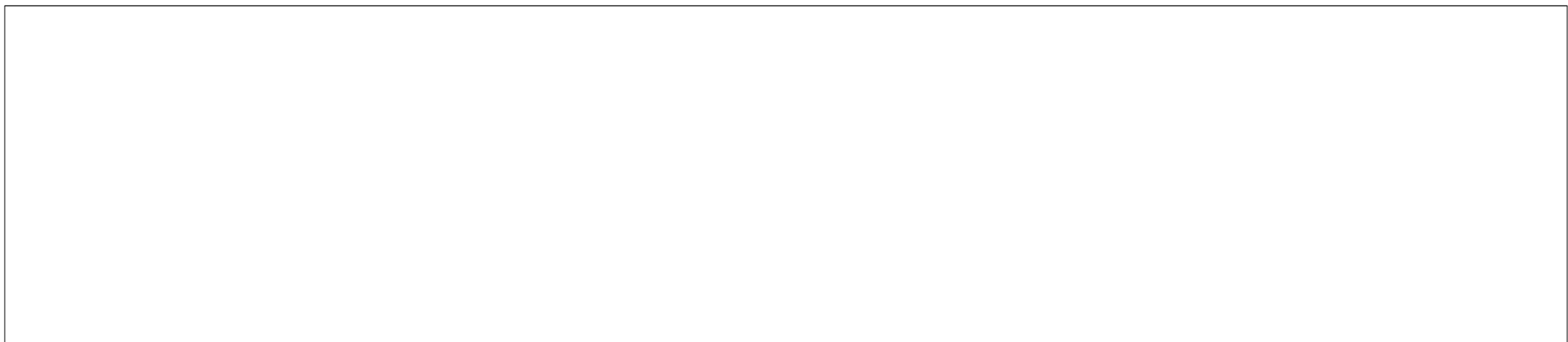
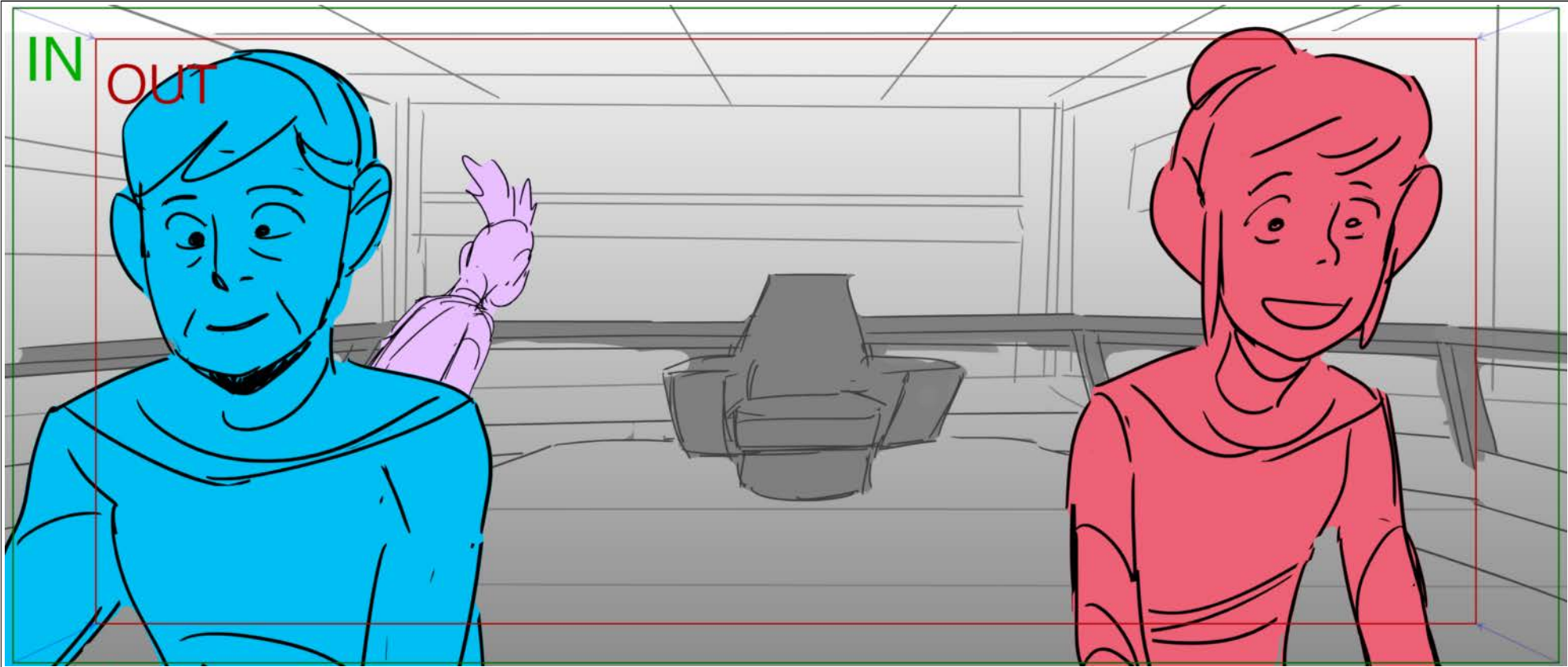

Scene	Duration	Panel	Duration
160	04:00	001A0	01:00

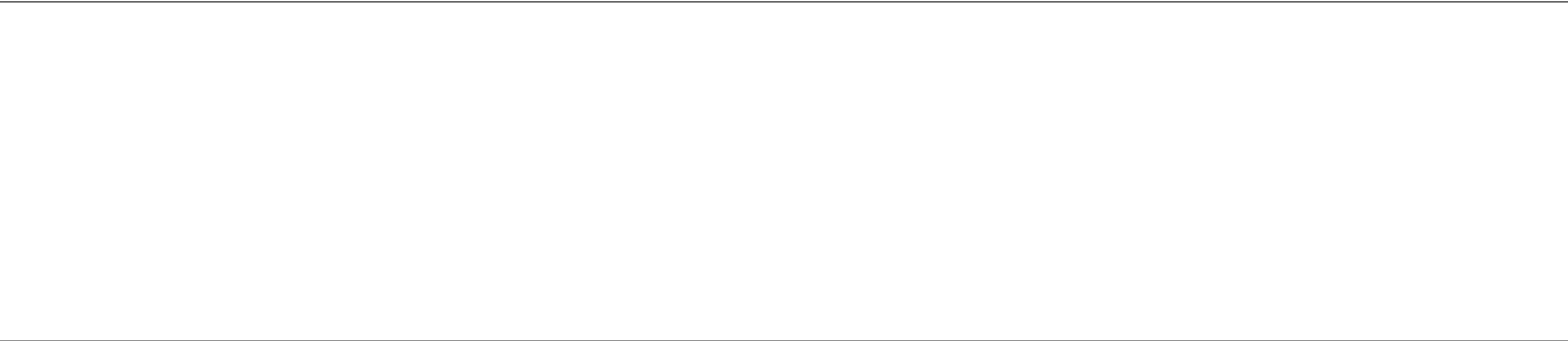

Scene	Duration	Panel	Duration
160	04:00	001A	00:12

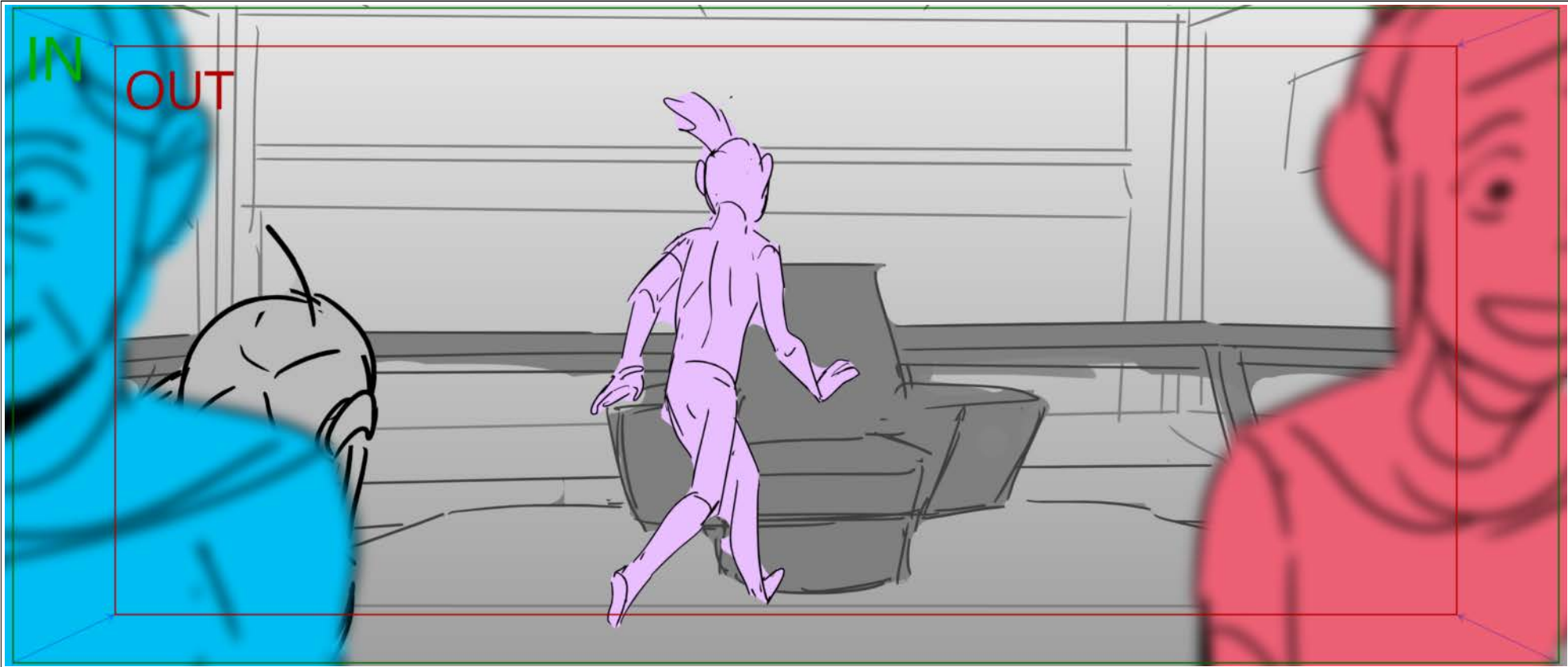

Scene	Duration	Panel	Duration
160	04:00	001B	00:12

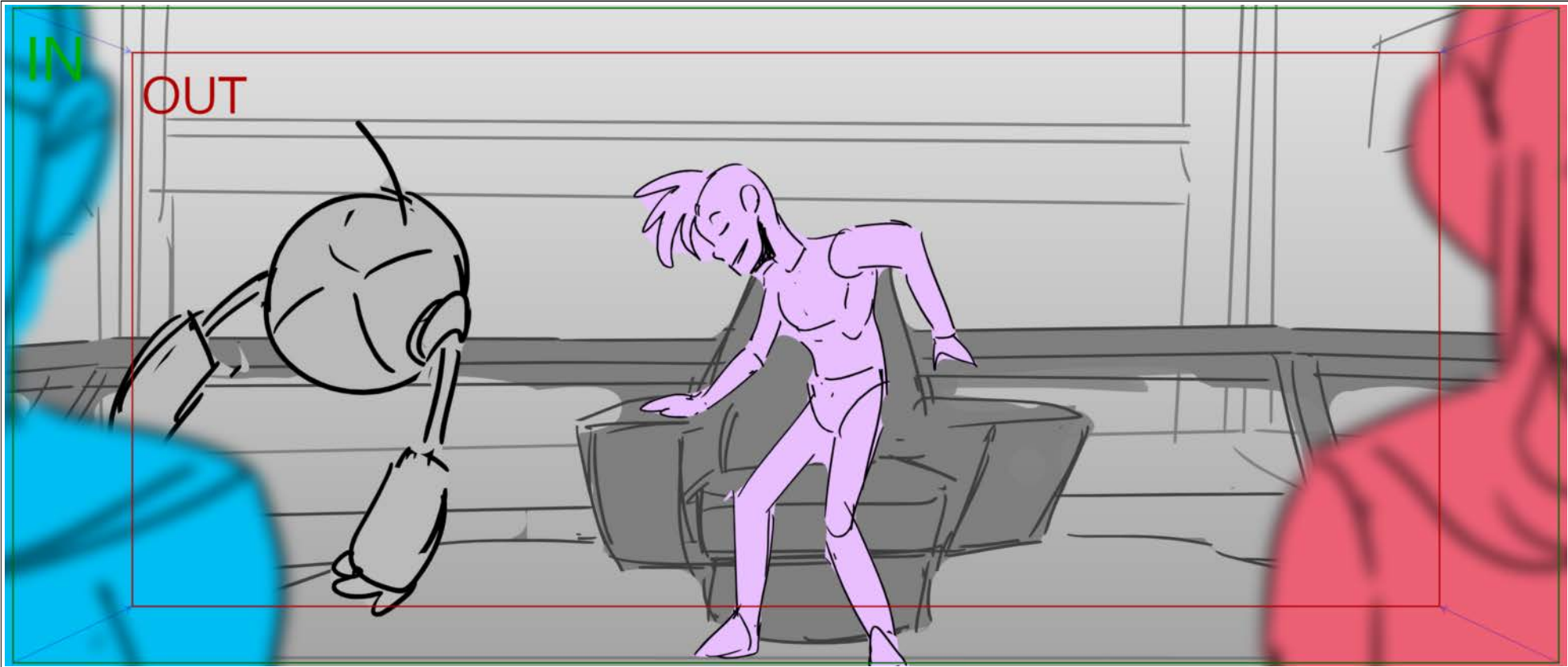

Scene	Duration	Panel	Duration
160	04:00	02A	00:10

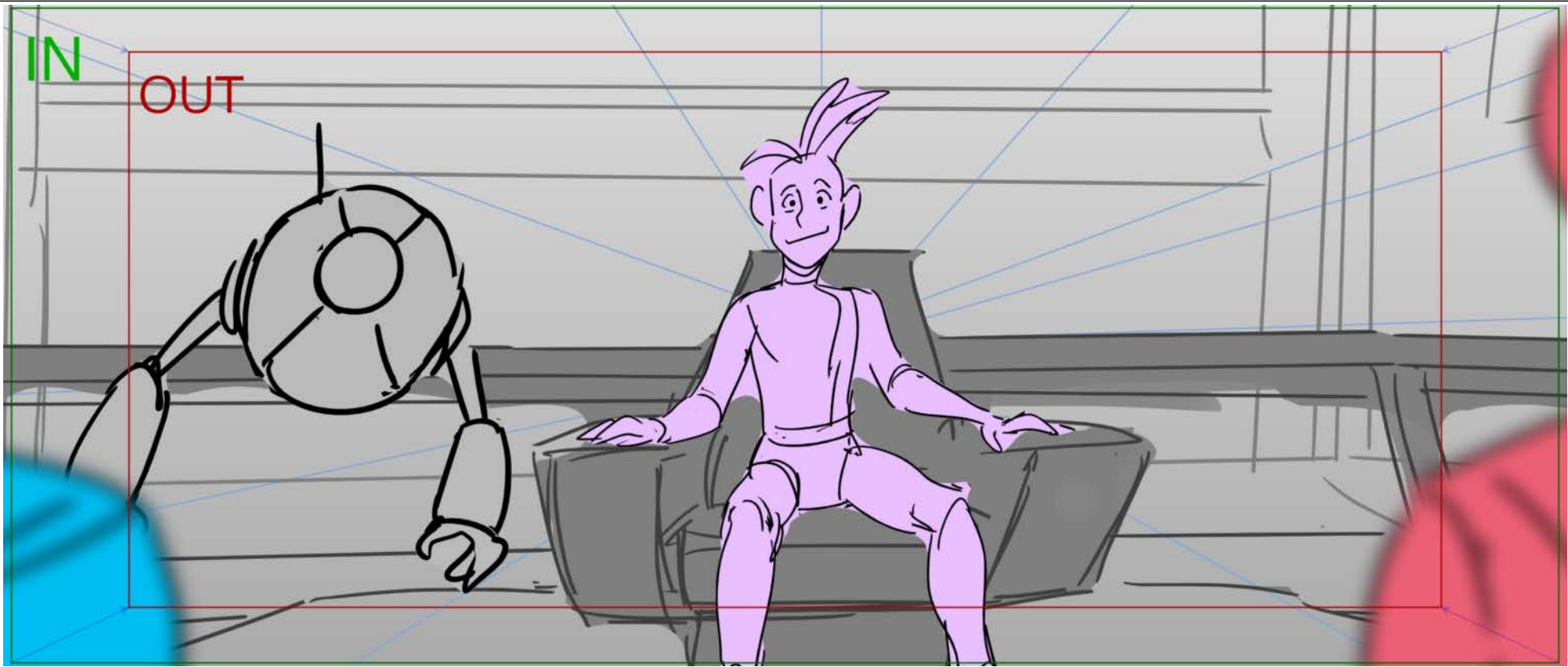

Scene	Duration	Panel	Duration
160	04:00	03A	00:14

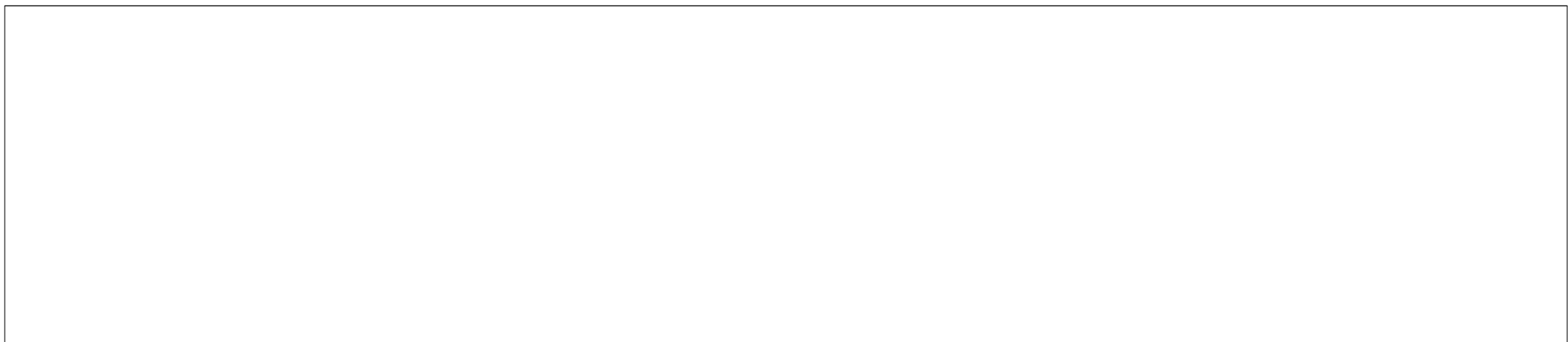
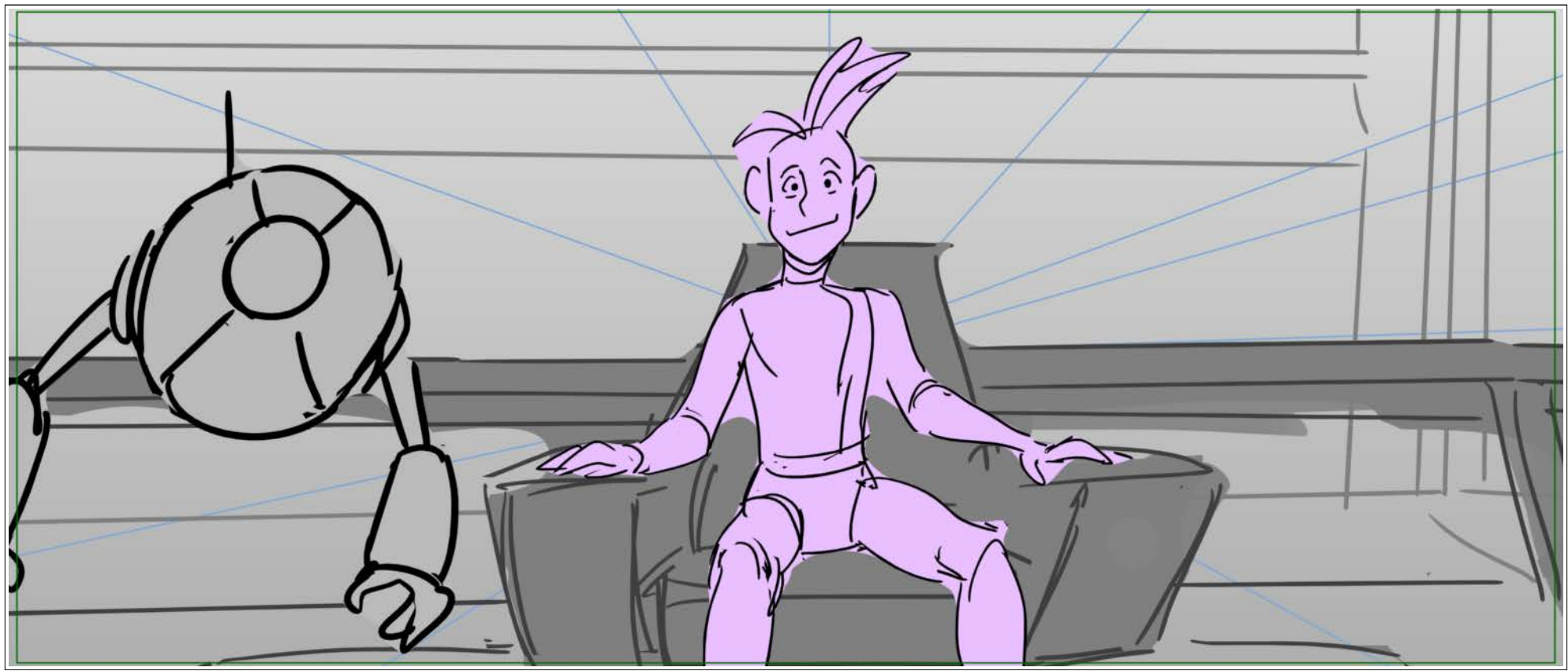

Scene	Duration	Panel	Duration
170	02:04	001	00:08

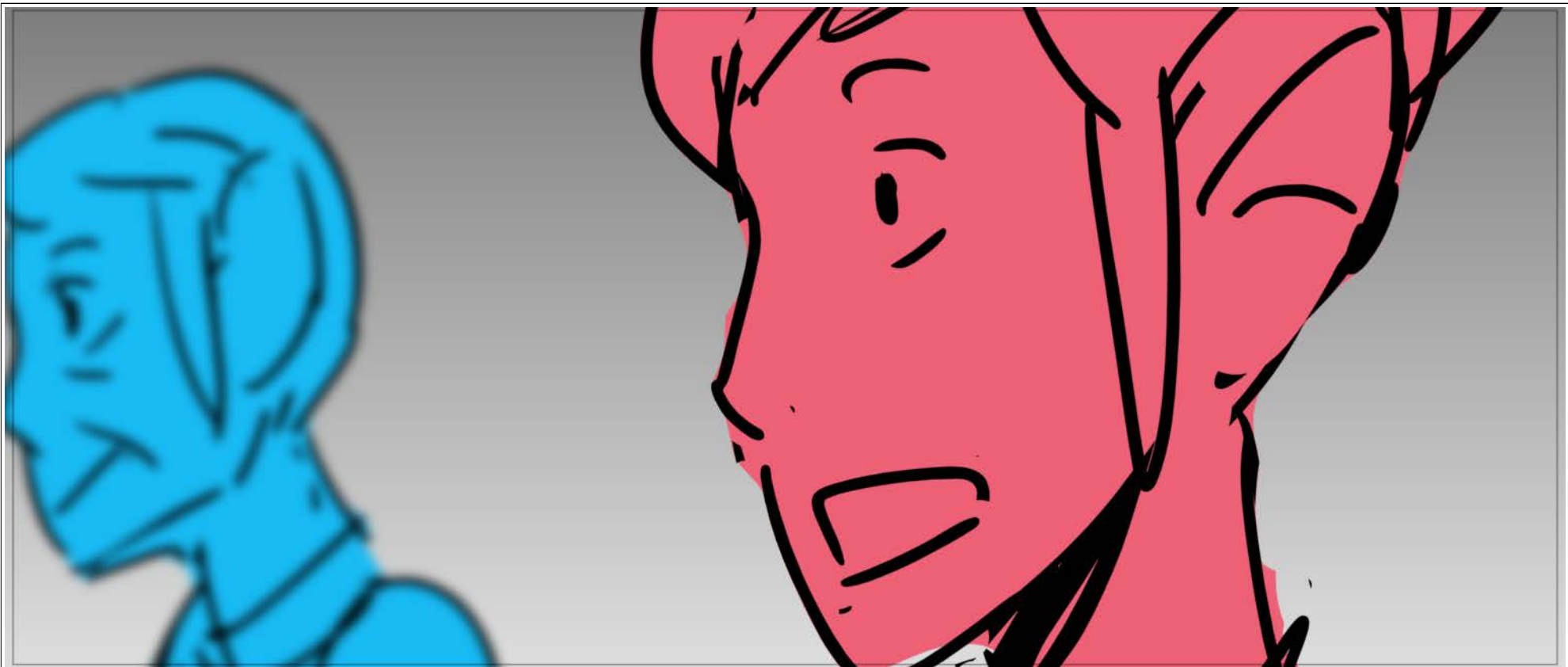

Scene	Duration	Panel	Duration
170	02:04	001_A_0	00:08

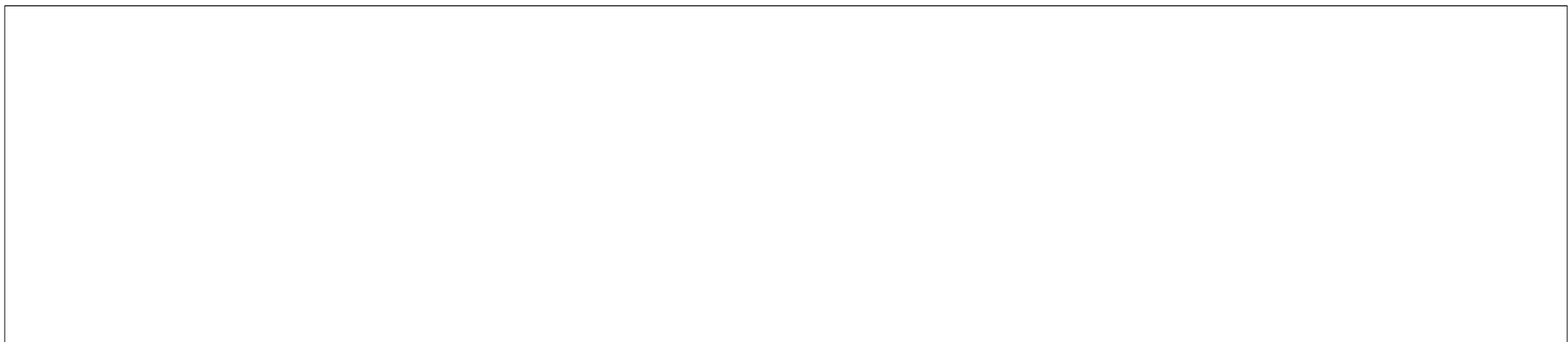

Scene	Duration	Panel	Duration
170	02:04	001_A_0_A	00:08

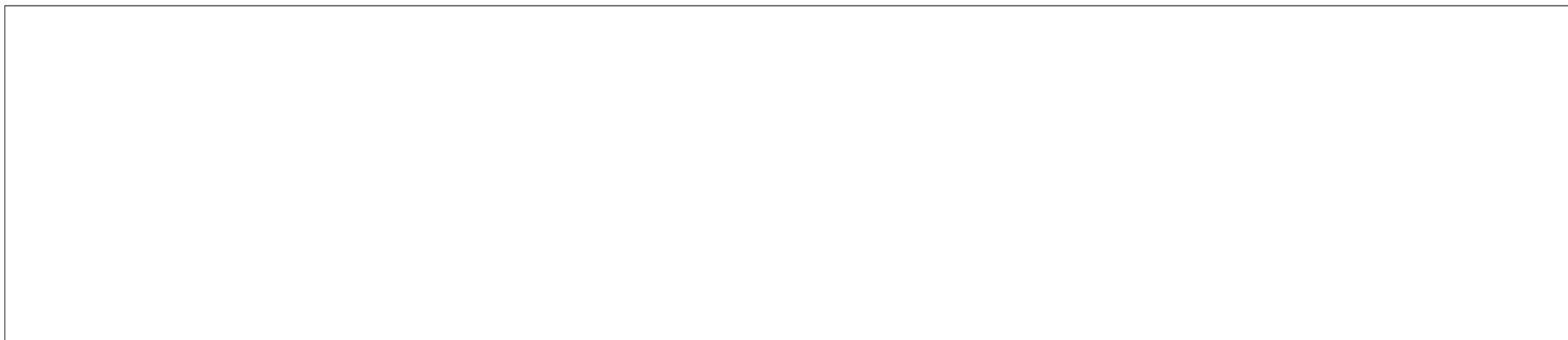

Scene	Duration	Panel	Duration
170	02:04	001_A	00:08

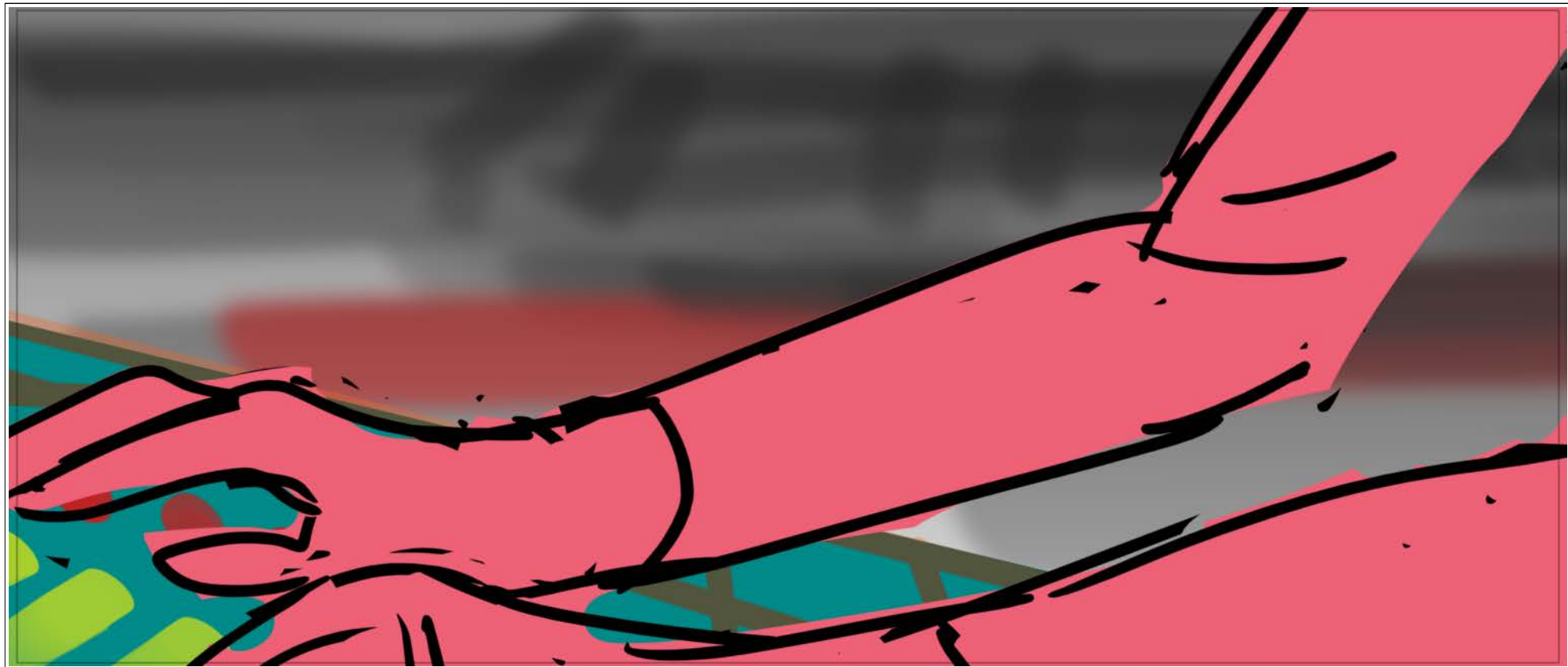

Scene	Duration	Panel	Duration
170	02:04	002	00:06

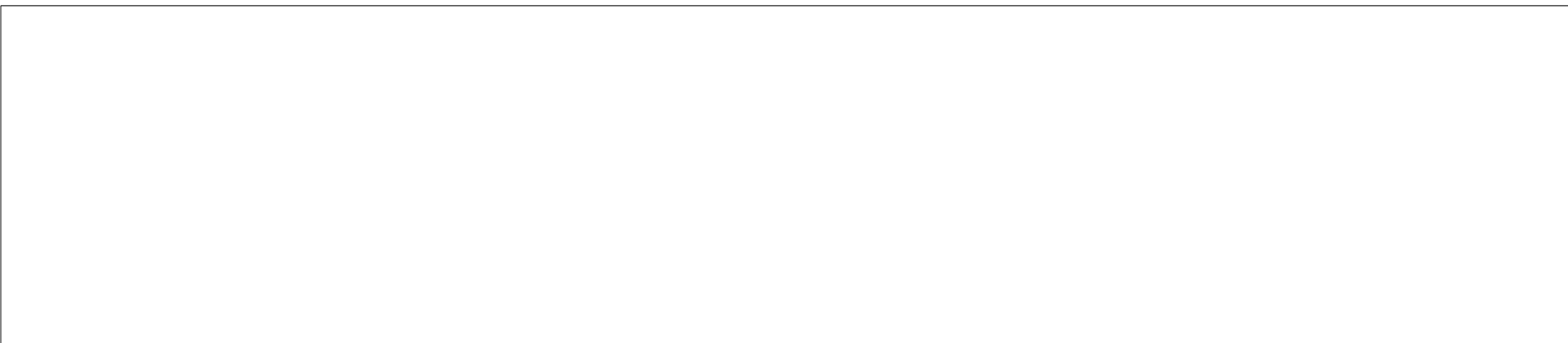
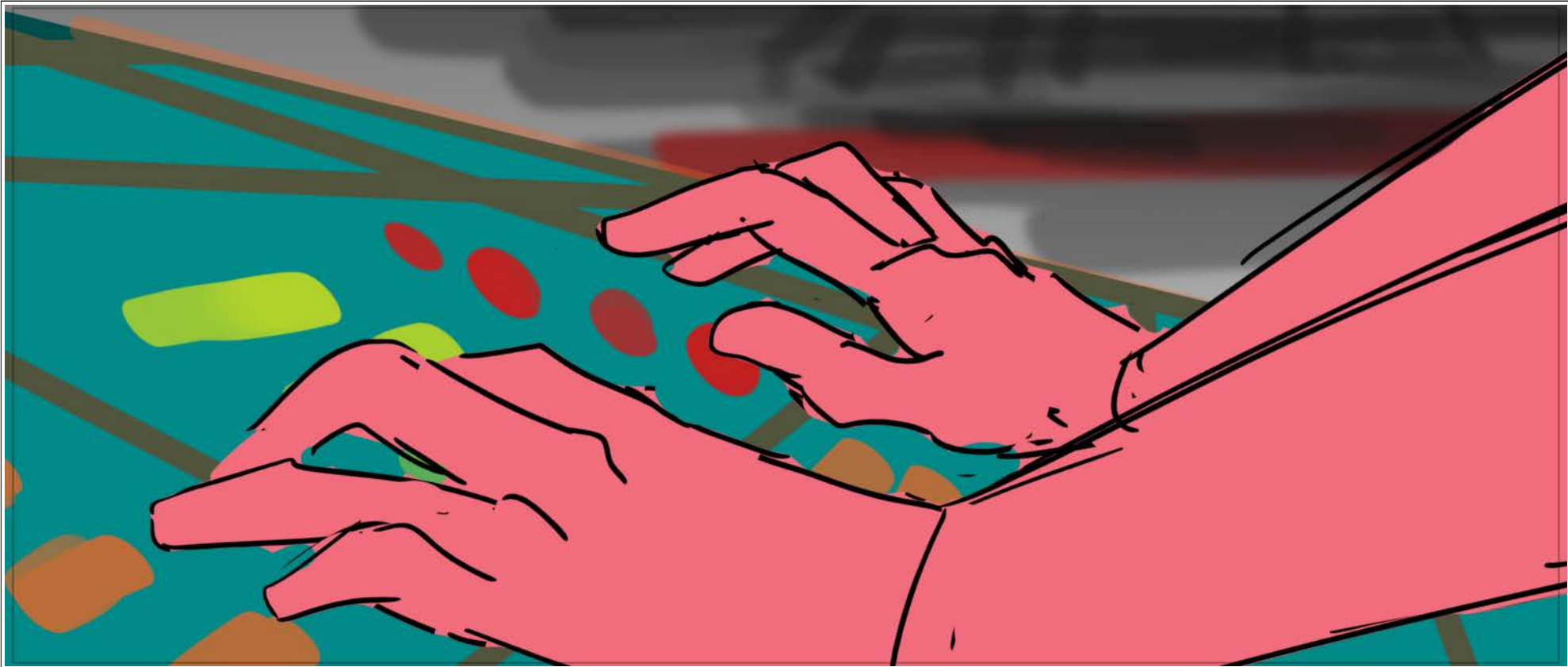

Scene	Duration	Panel	Duration
170	02:04	001A	00:08

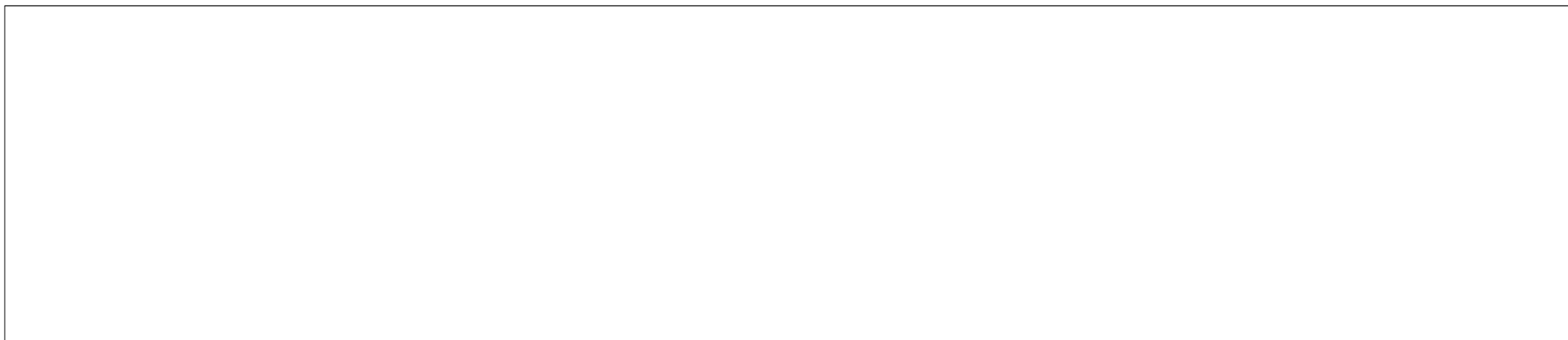
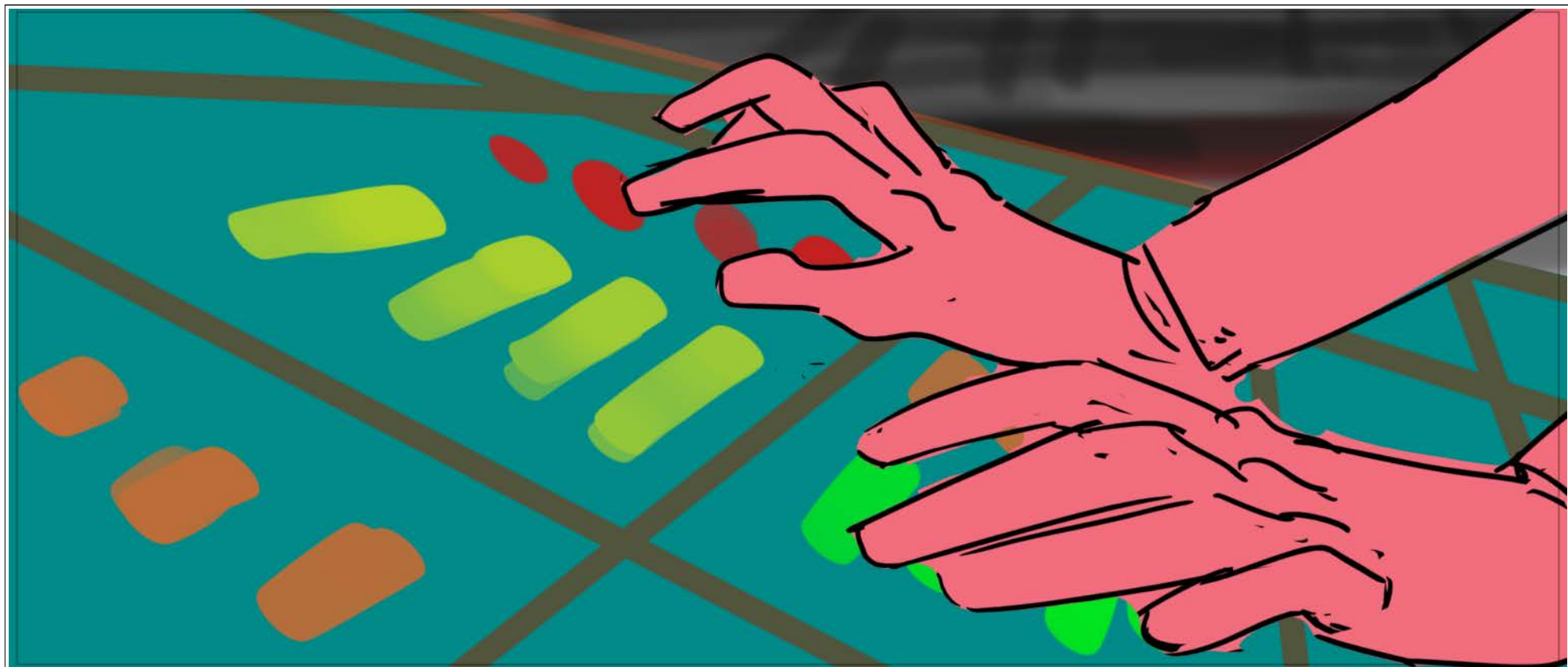

Scene	Duration	Panel	Duration
170	02:04	002A	00:06

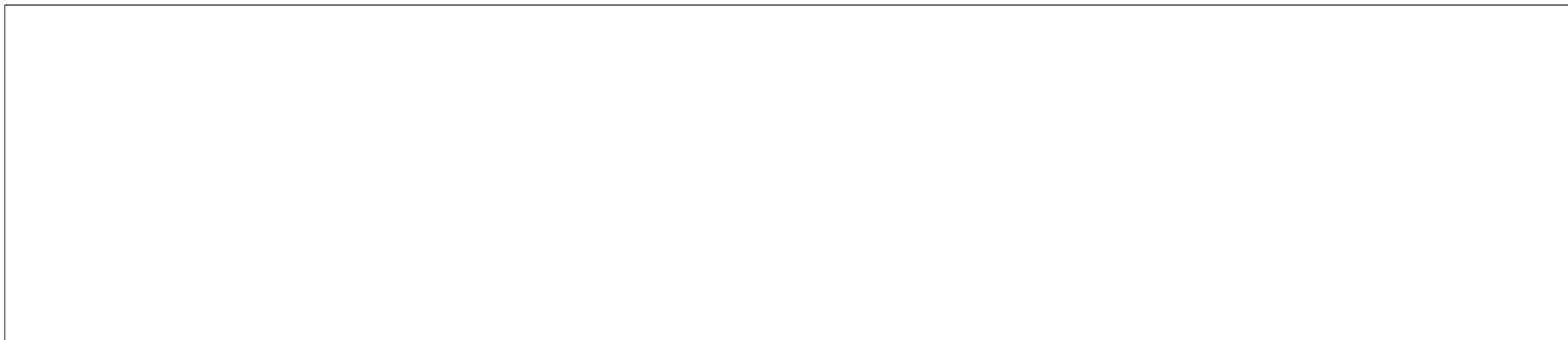
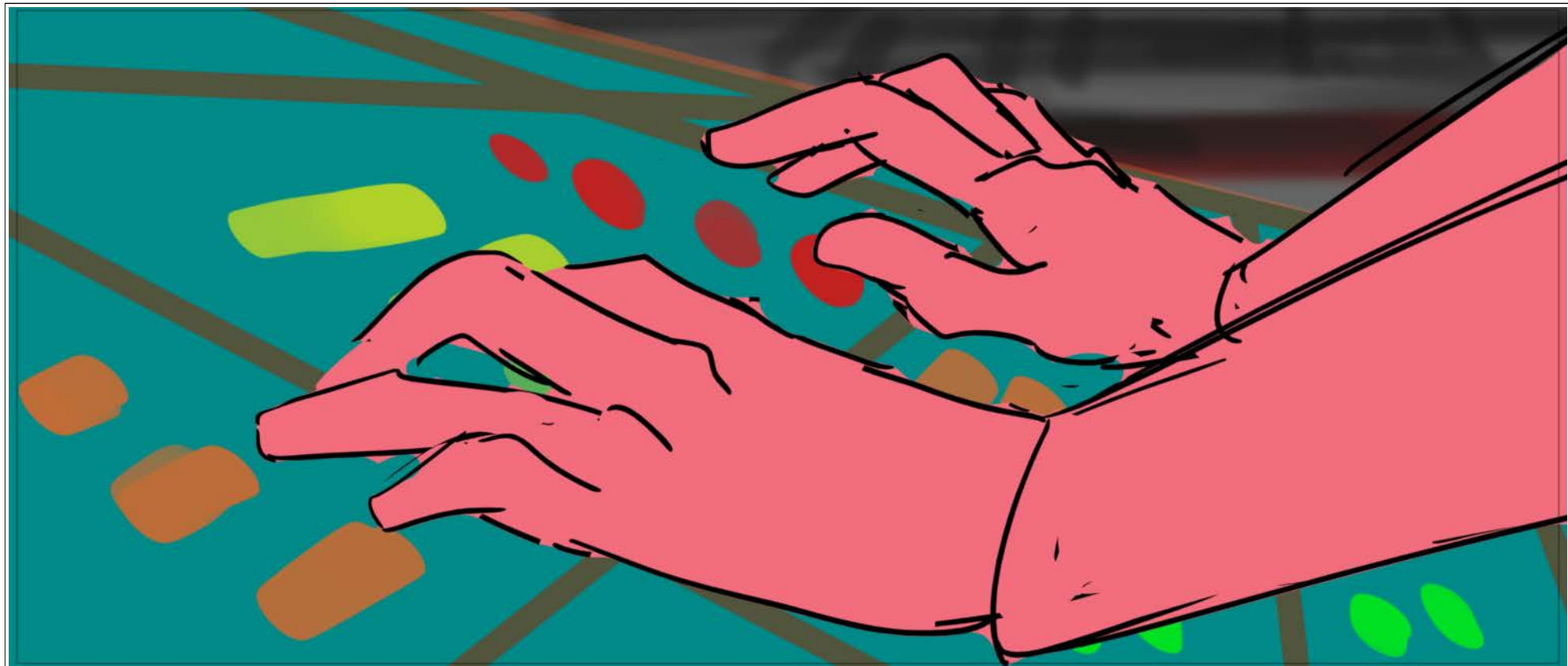

Scene	Duration	Panel	Duration
180	07:00	001	01:00

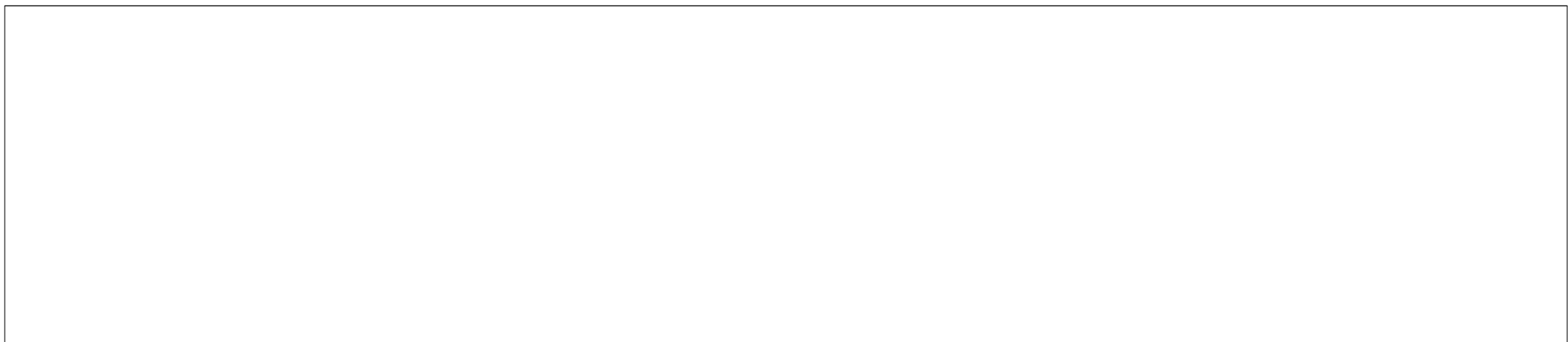

Scene	Duration	Panel	Duration
180	07:00	001A	01:00

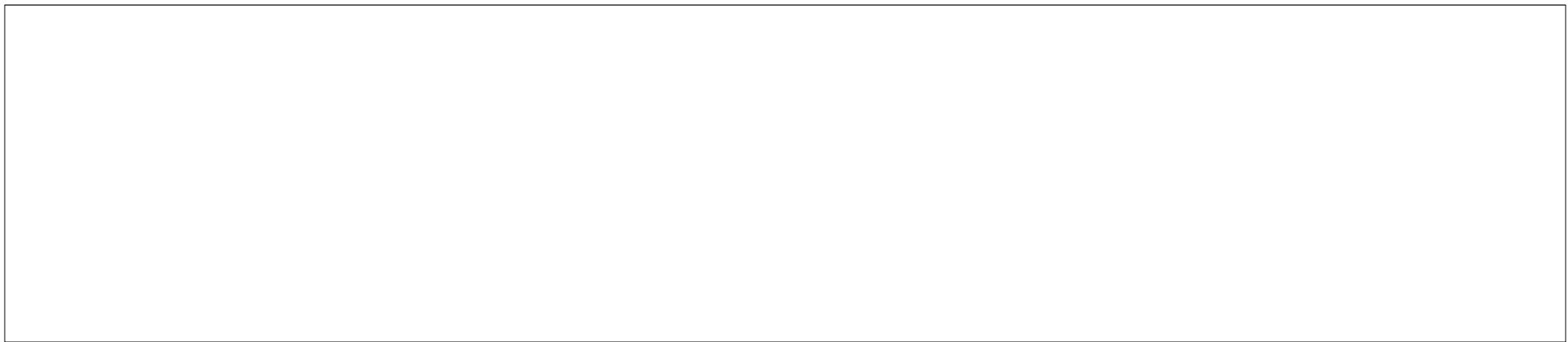

Scene	Duration	Panel	Duration
180	07:00	001B	01:00



Scene	Duration	Panel	Duration
180	07:00	001C	01:00



Scene	Duration	Panel	Duration
180	07:00	001D	01:00

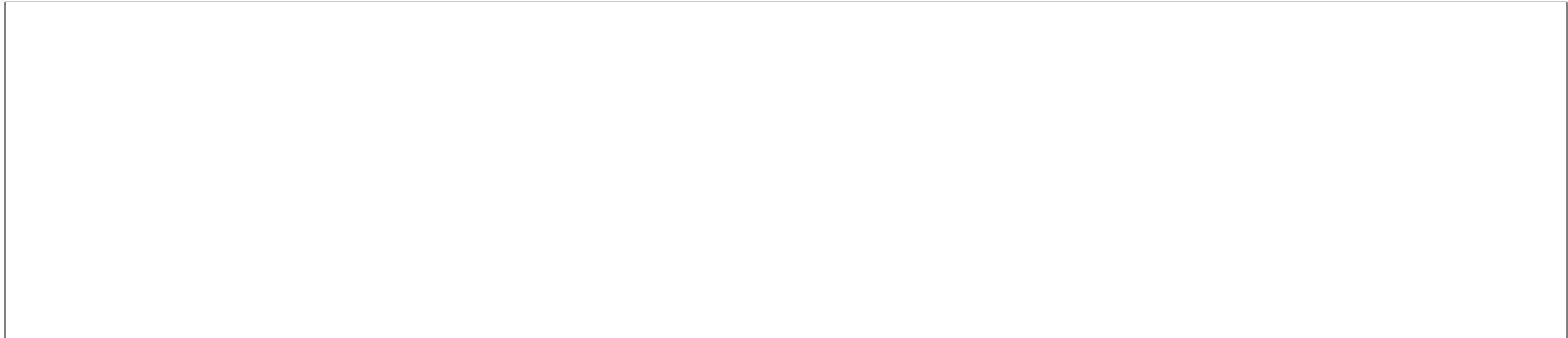

Scene	Duration	Panel	Duration
180	07:00	02D	01:00

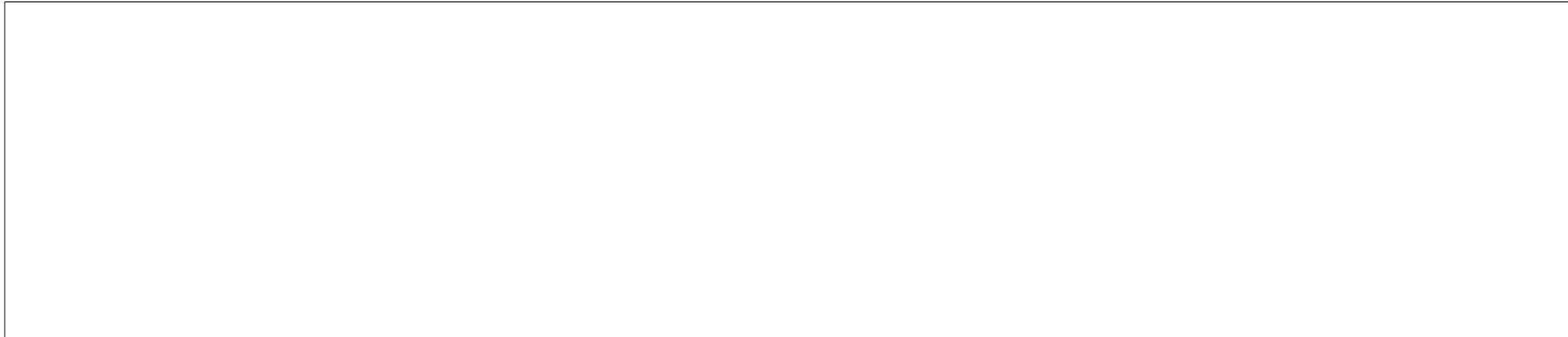

Scene	Duration	Panel	Duration
180	07:00	02E	01:00

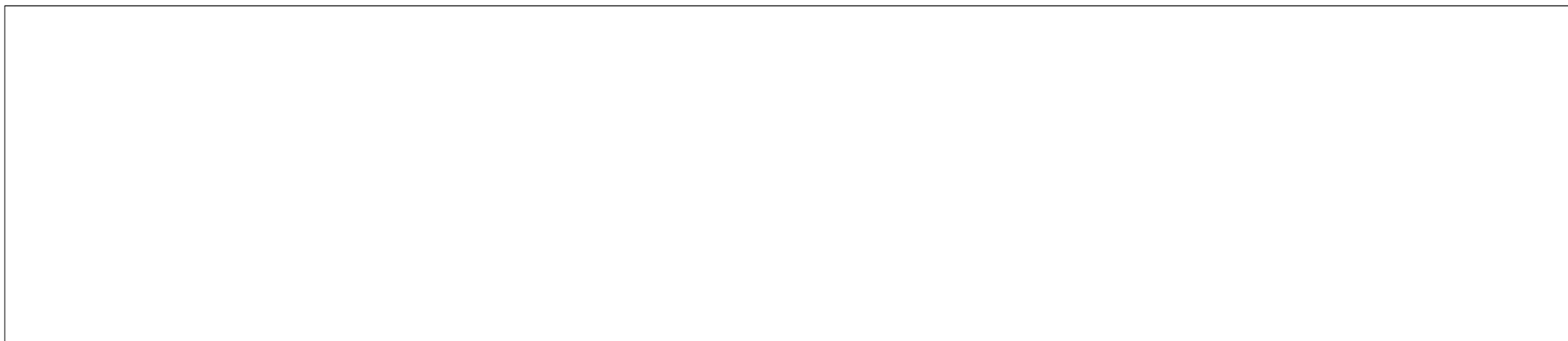
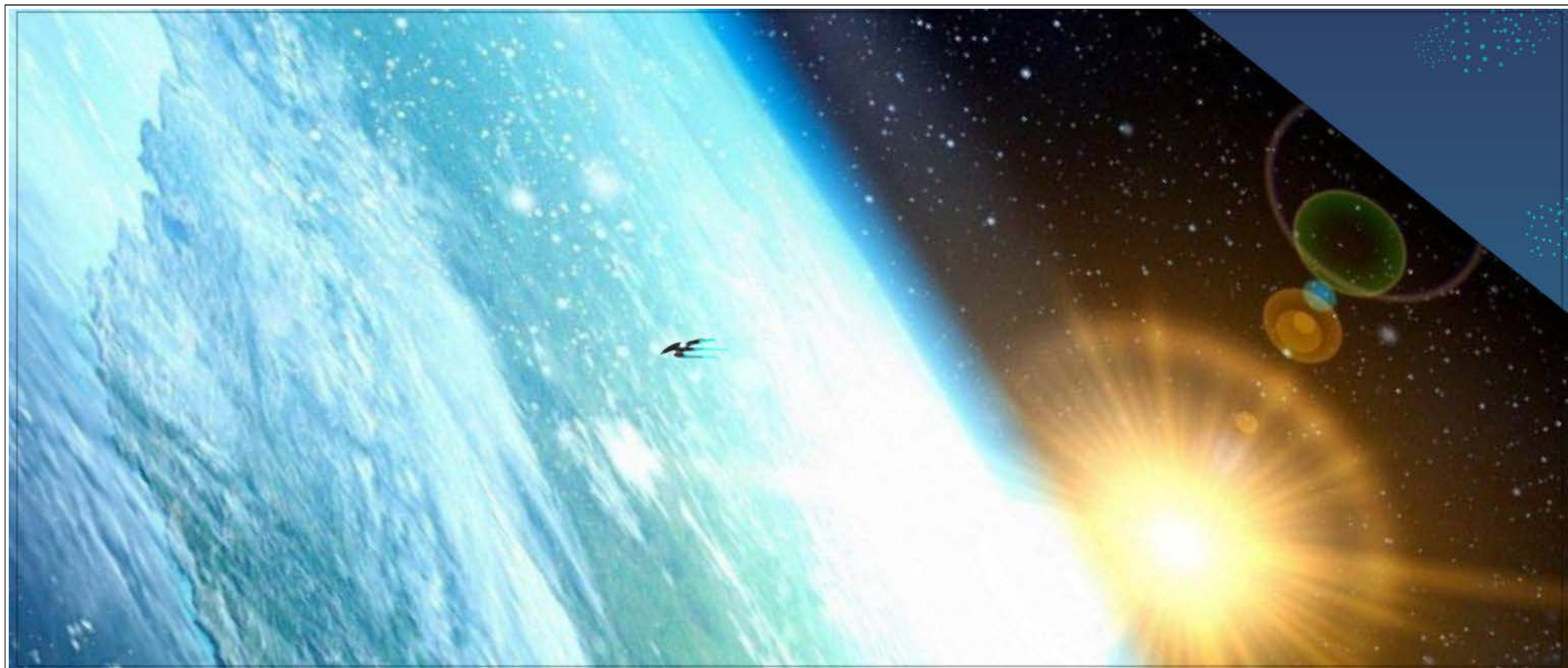

Scene	Duration	Panel	Duration
190	01:00	001	00:10

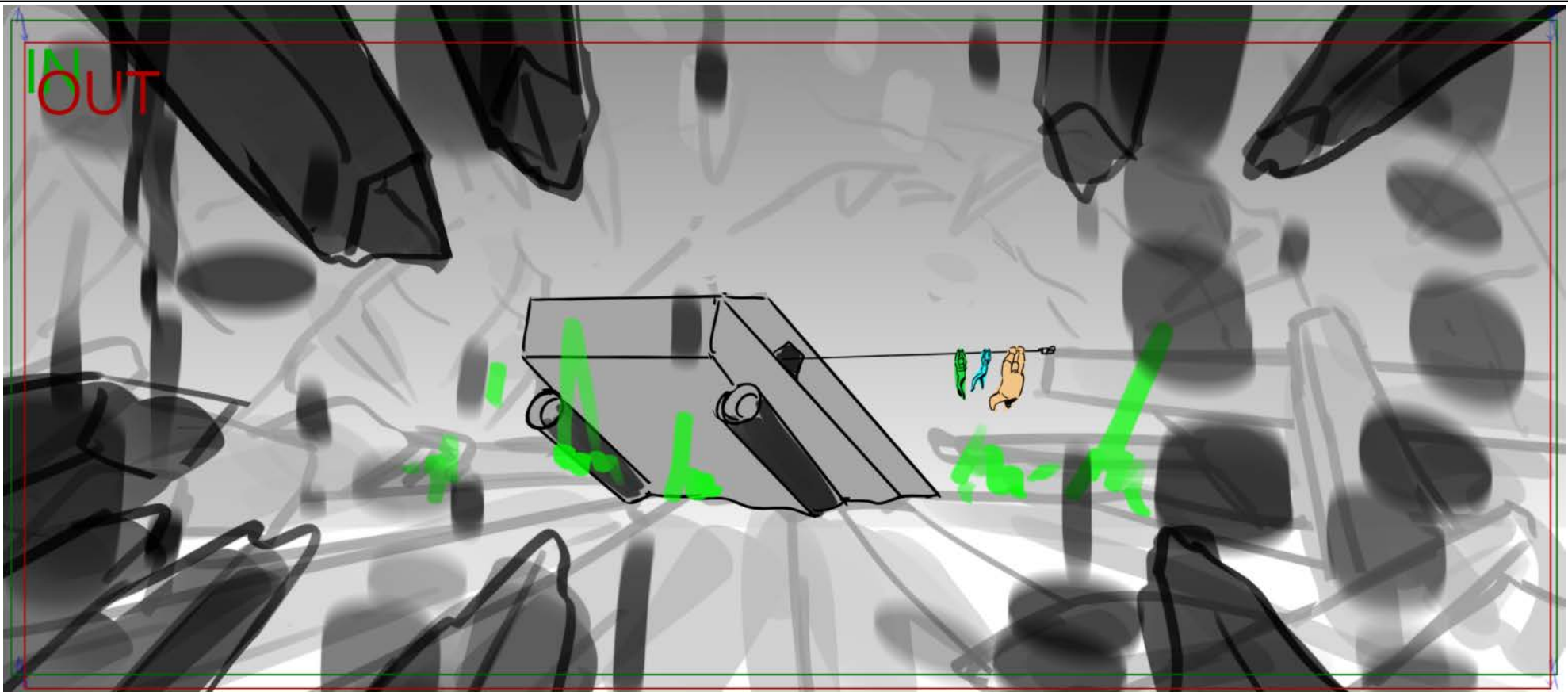

Scene	Duration	Panel	Duration
190	01:00	002	00:07

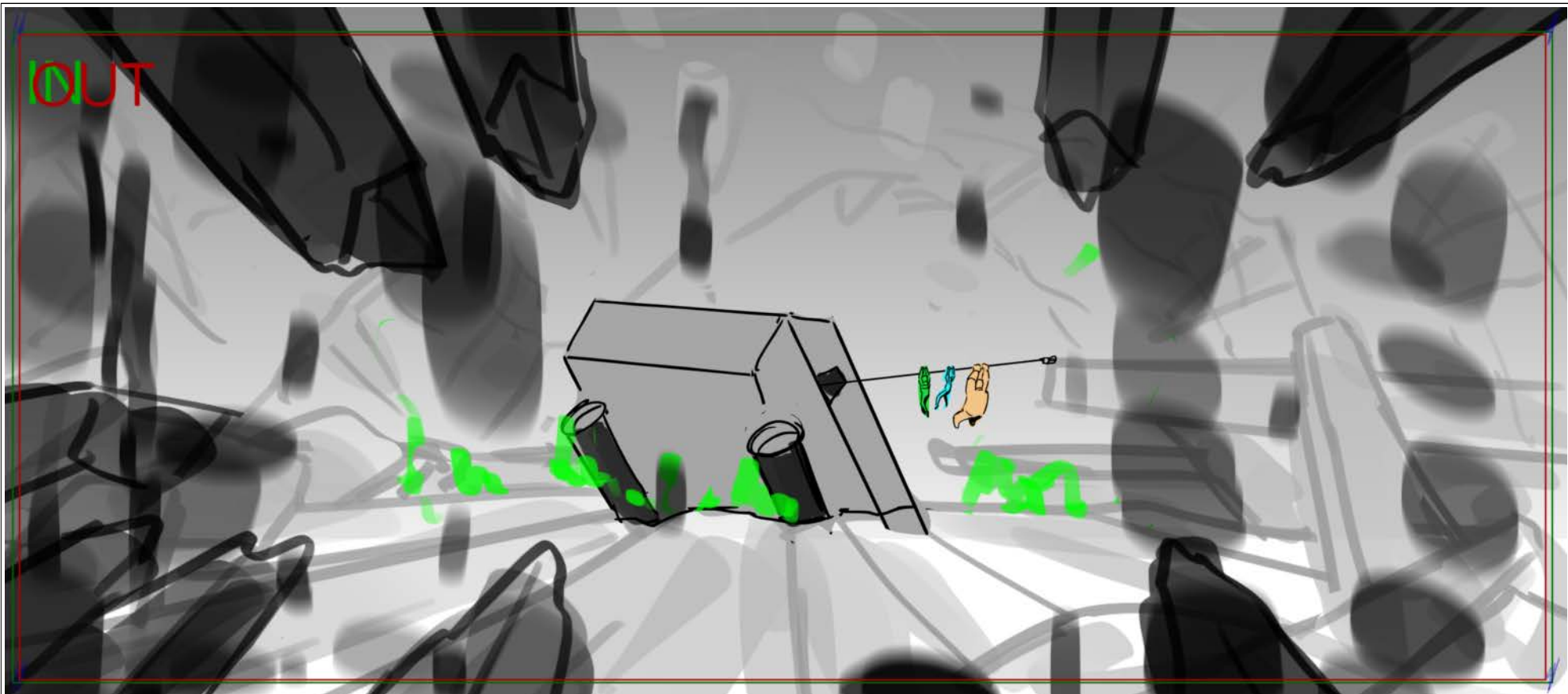

Scene	Duration	Panel	Duration
190	01:00	003	00:07

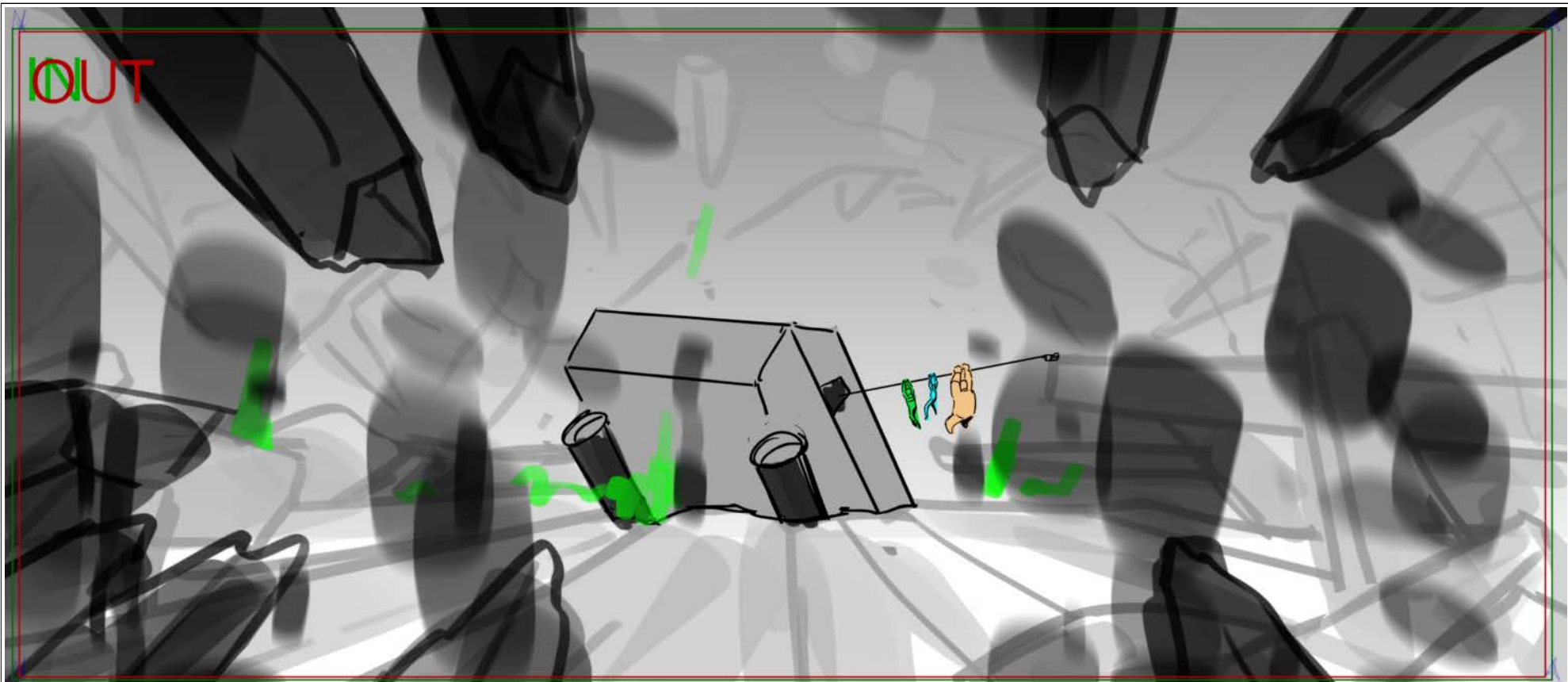

Scene	Duration	Panel	Duration
195	01:16	001	00:10

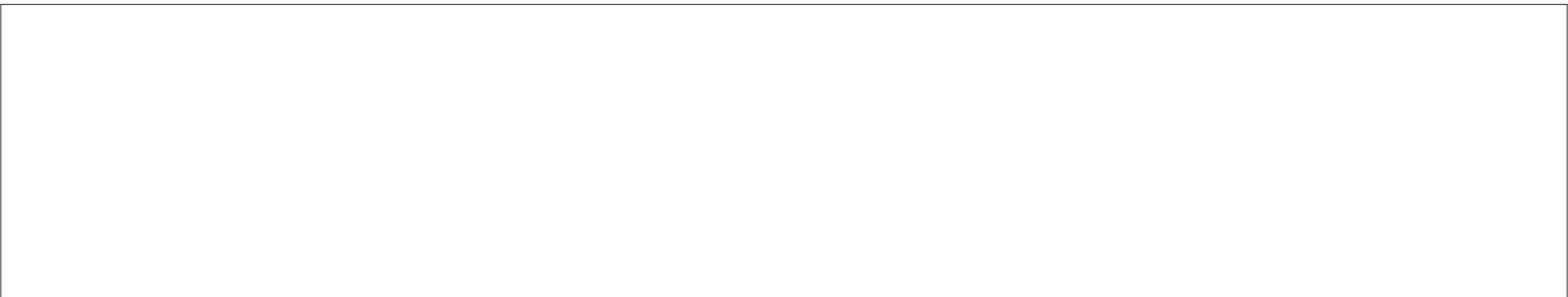
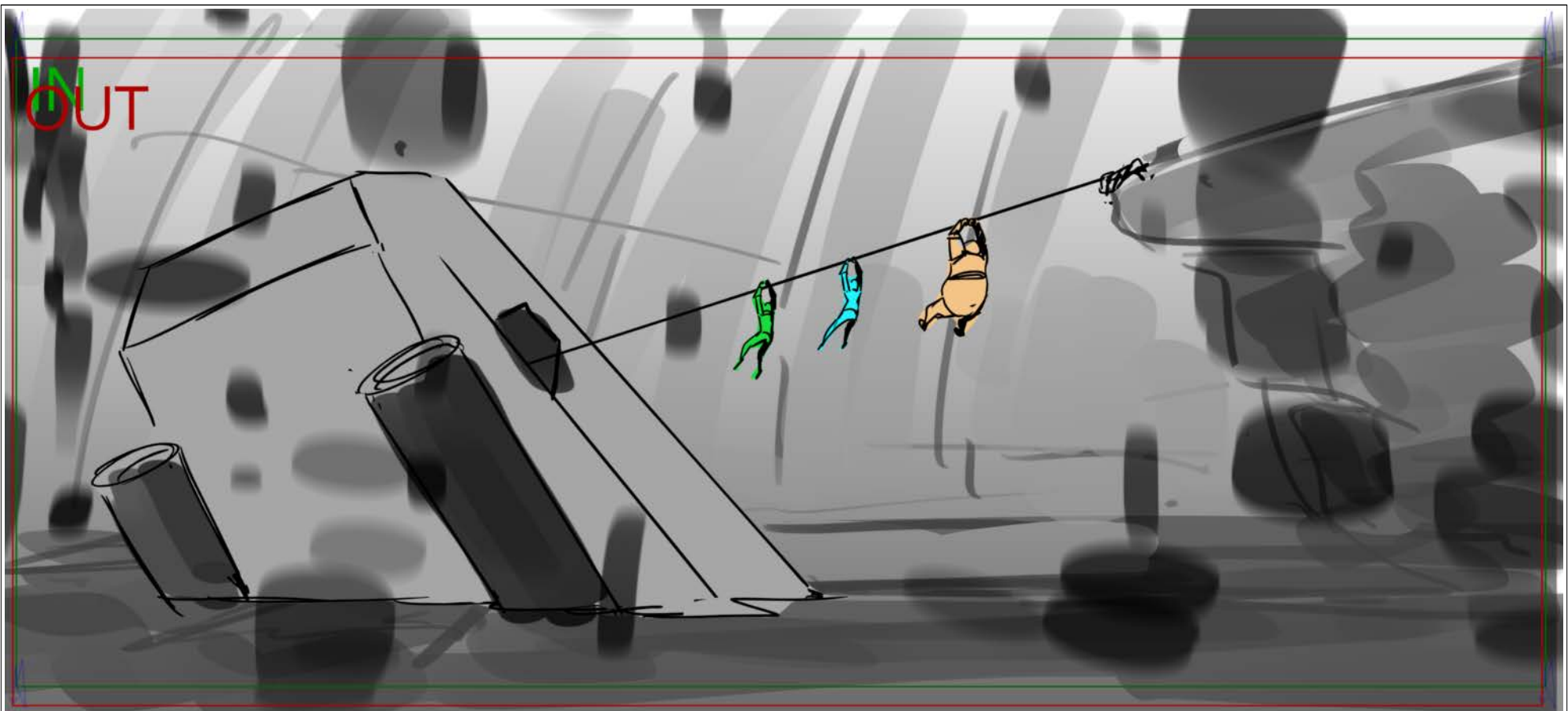

Scene	Duration	Panel	Duration
195	01:16	001A	00:10

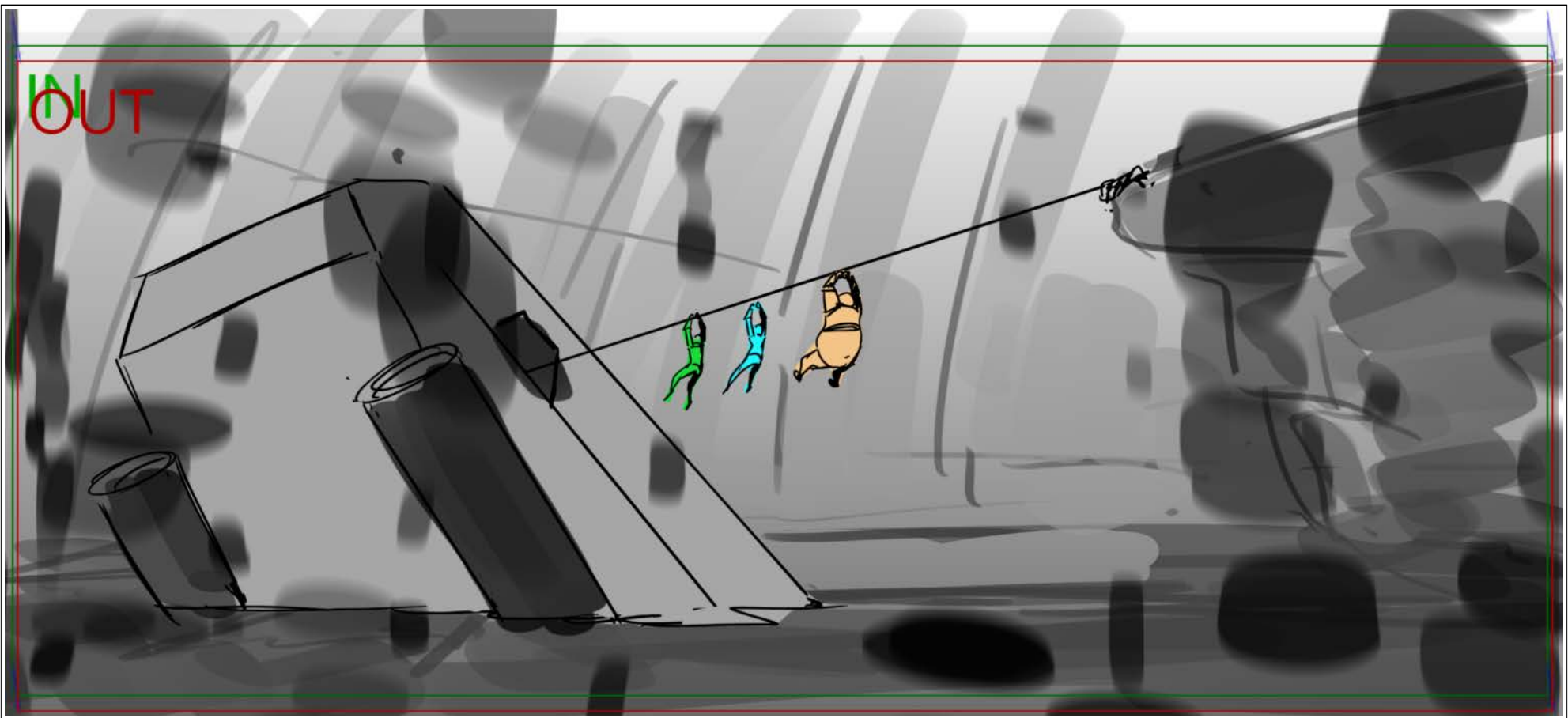

Scene	Duration	Panel	Duration
195	01:16	001B	00:10

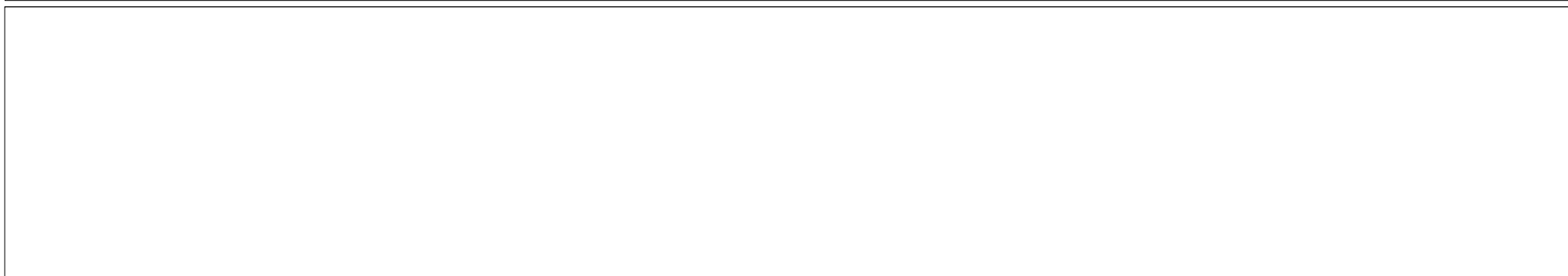
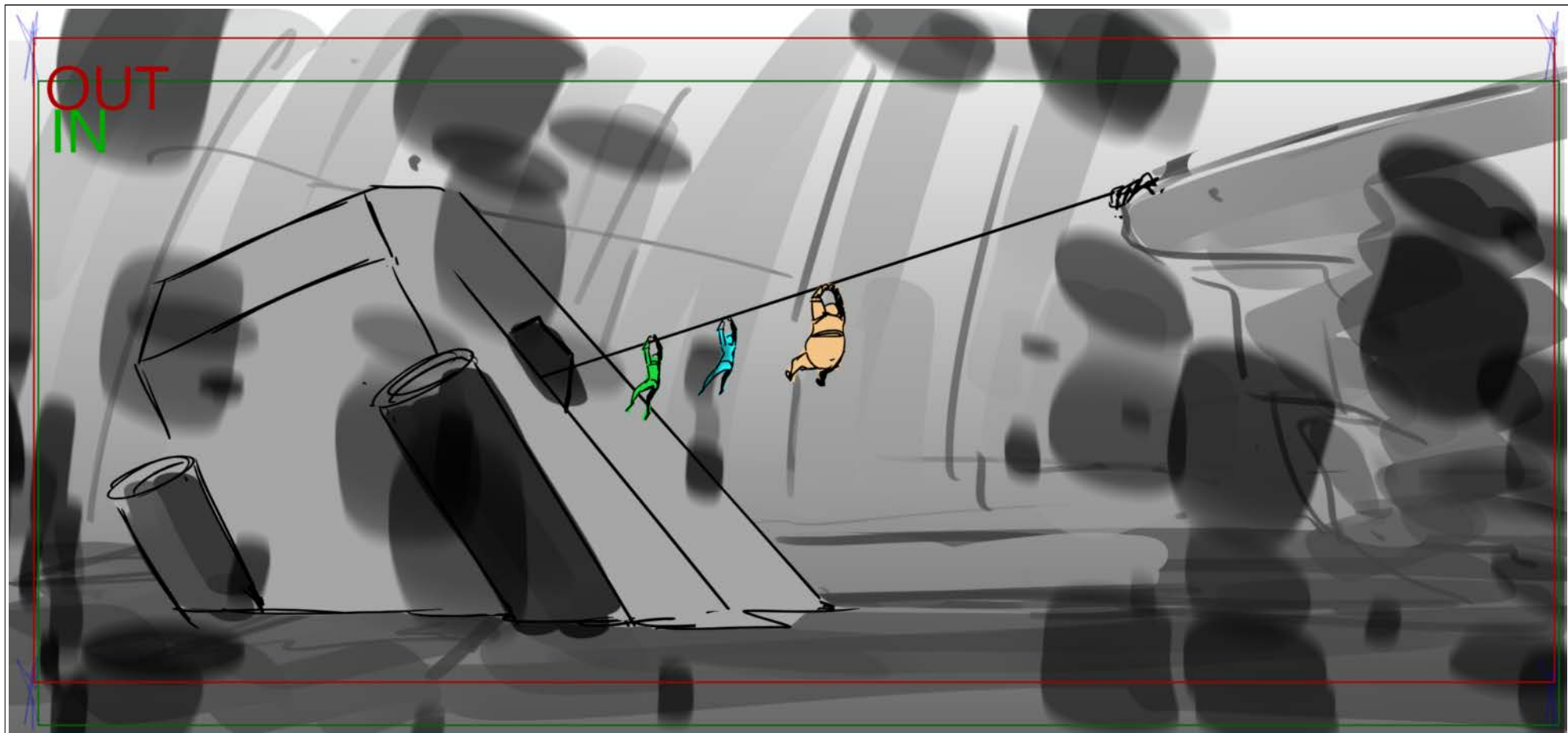

Scene	Duration	Panel	Duration
195	01:16	001C	00:10

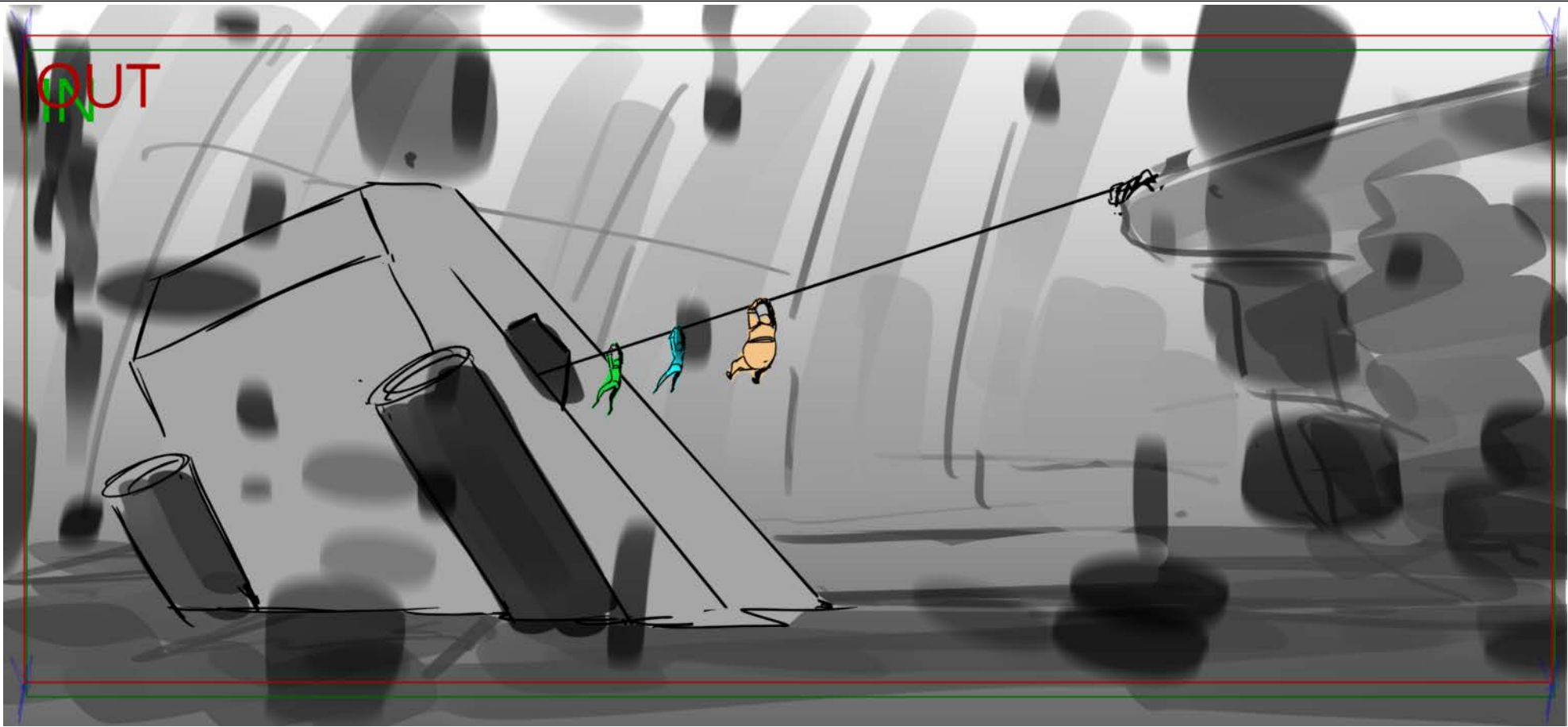

Scene	Duration	Panel	Duration
200	02:15	001	00:12

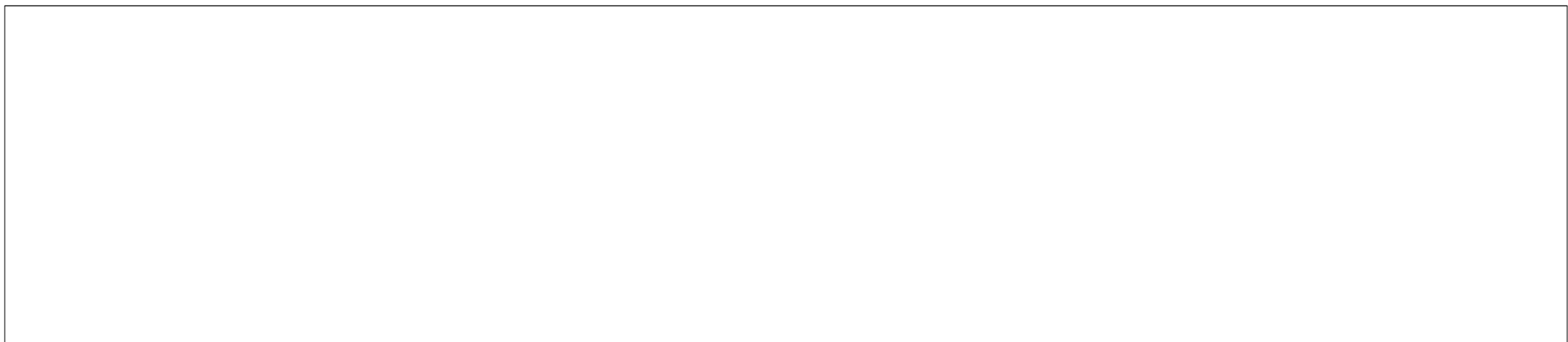
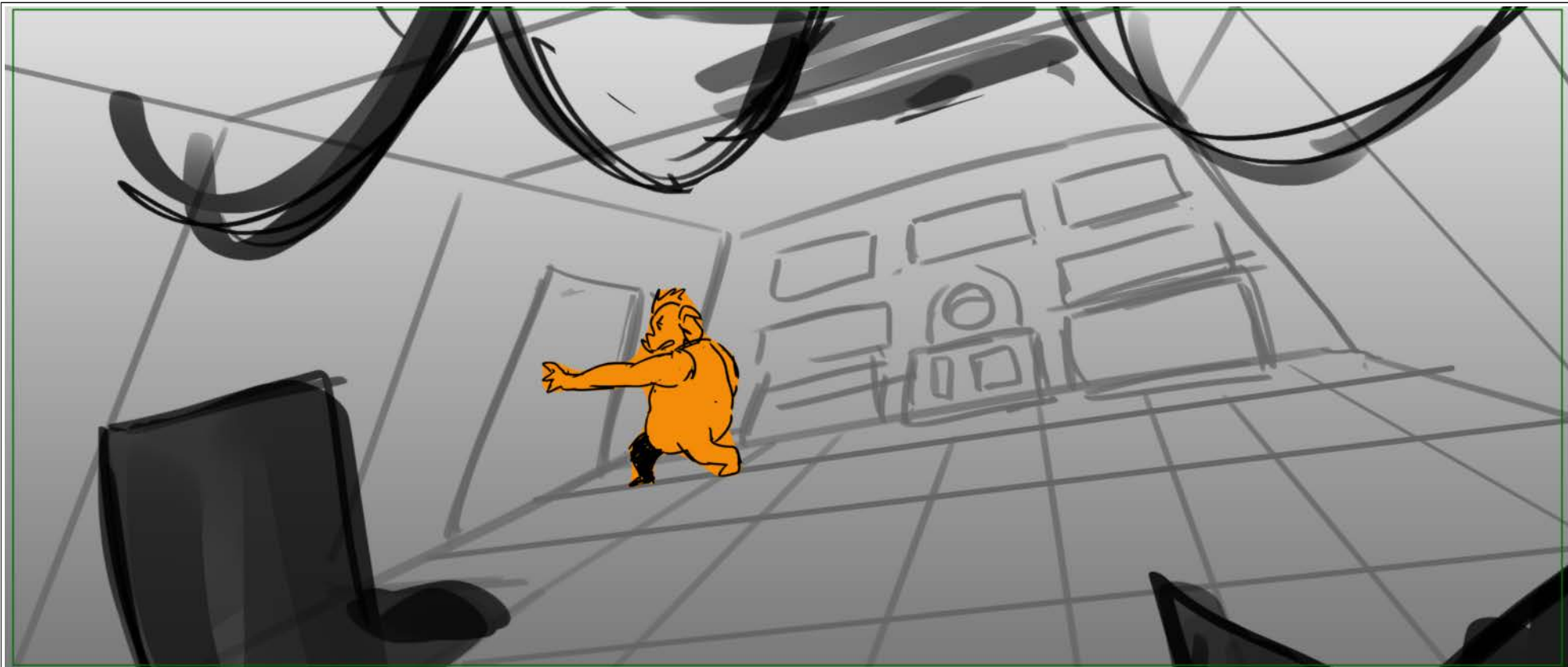

Scene	Duration	Panel	Duration
200	02:15	001A0	00:14

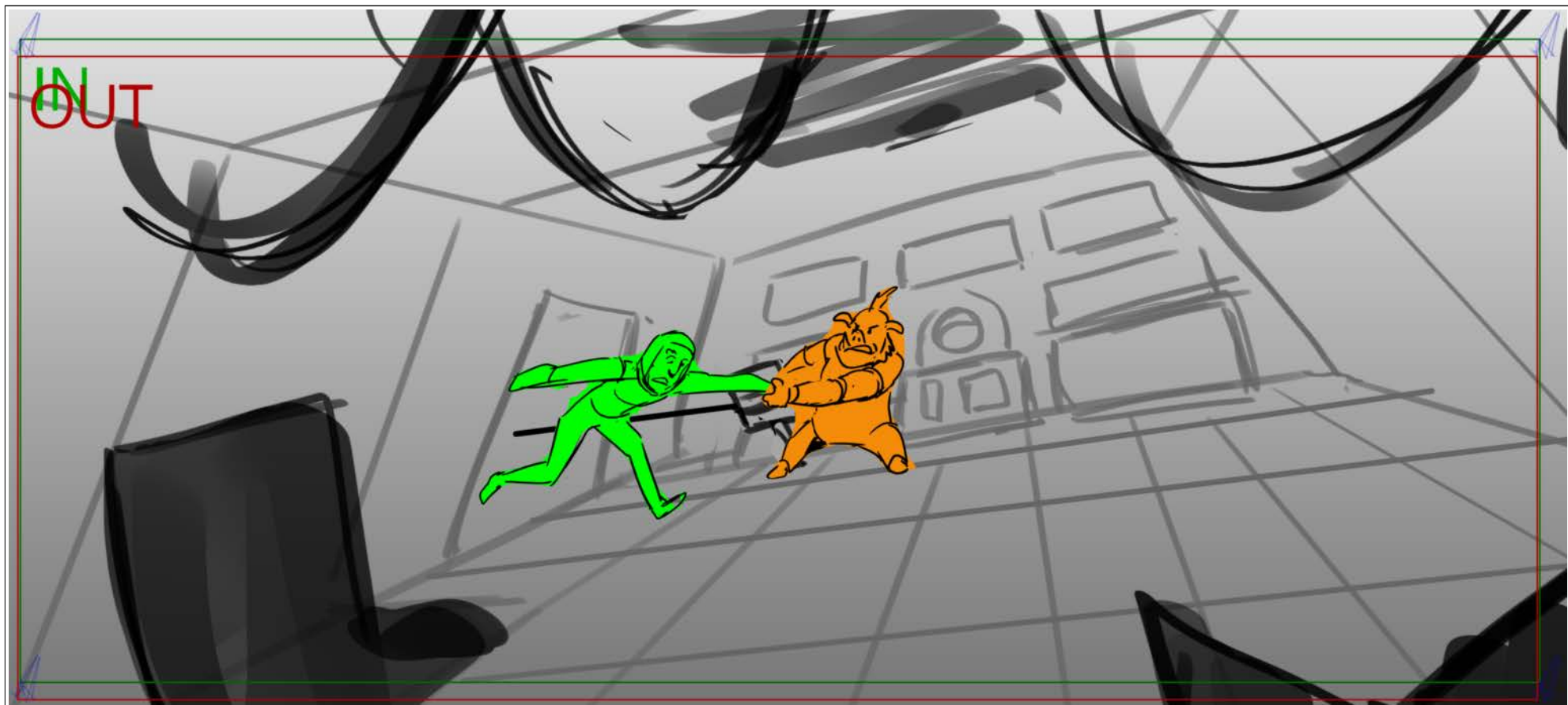

Scene	Duration	Panel	Duration
200	02:15	001A	00:12

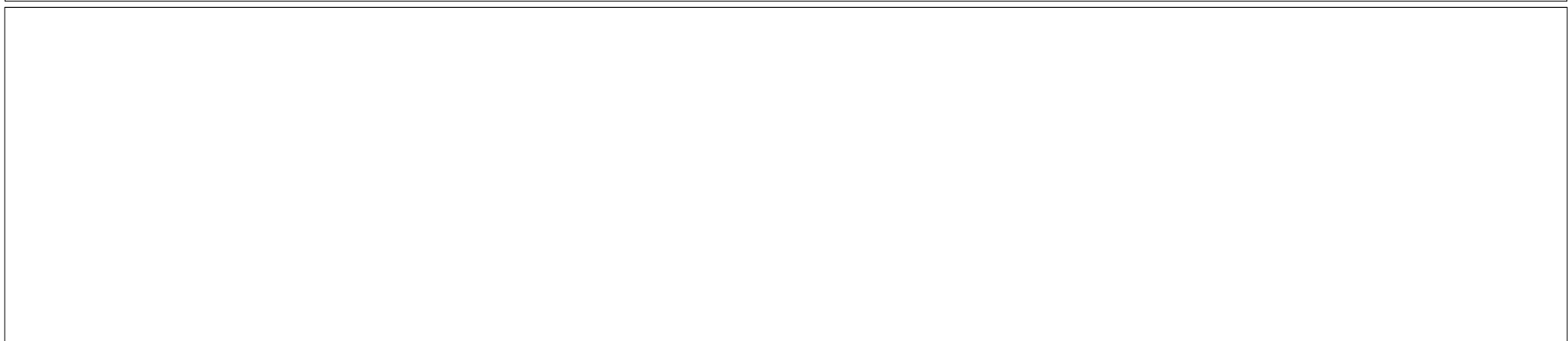
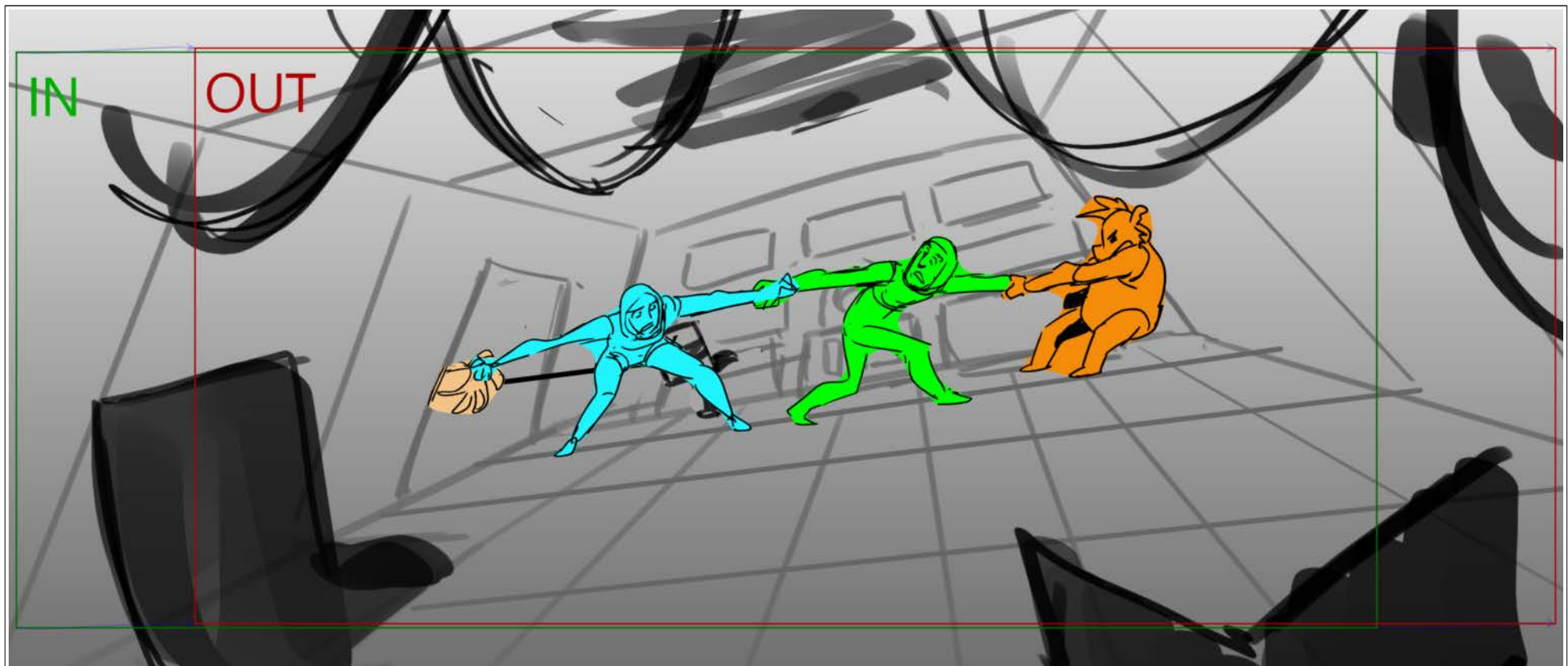

Scene	Duration	Panel	Duration
200	02:15	02A	00:14

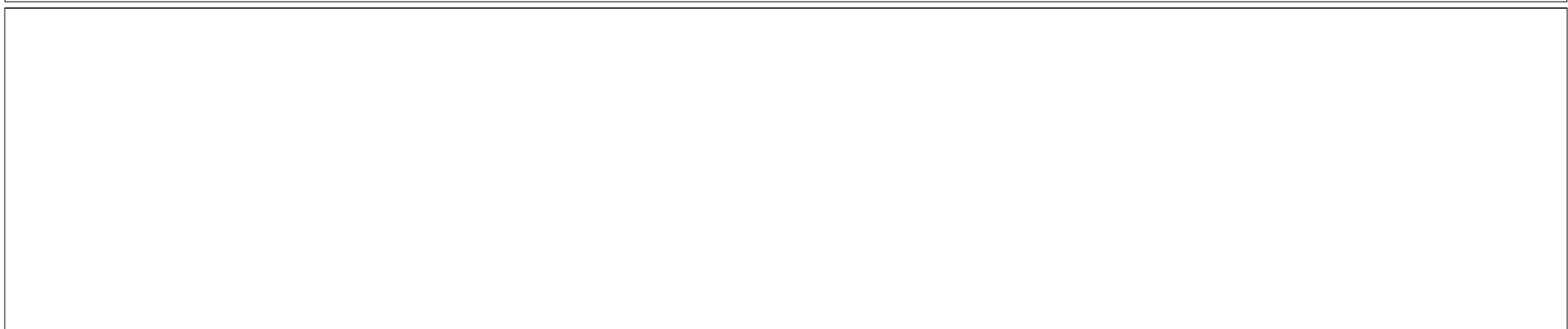
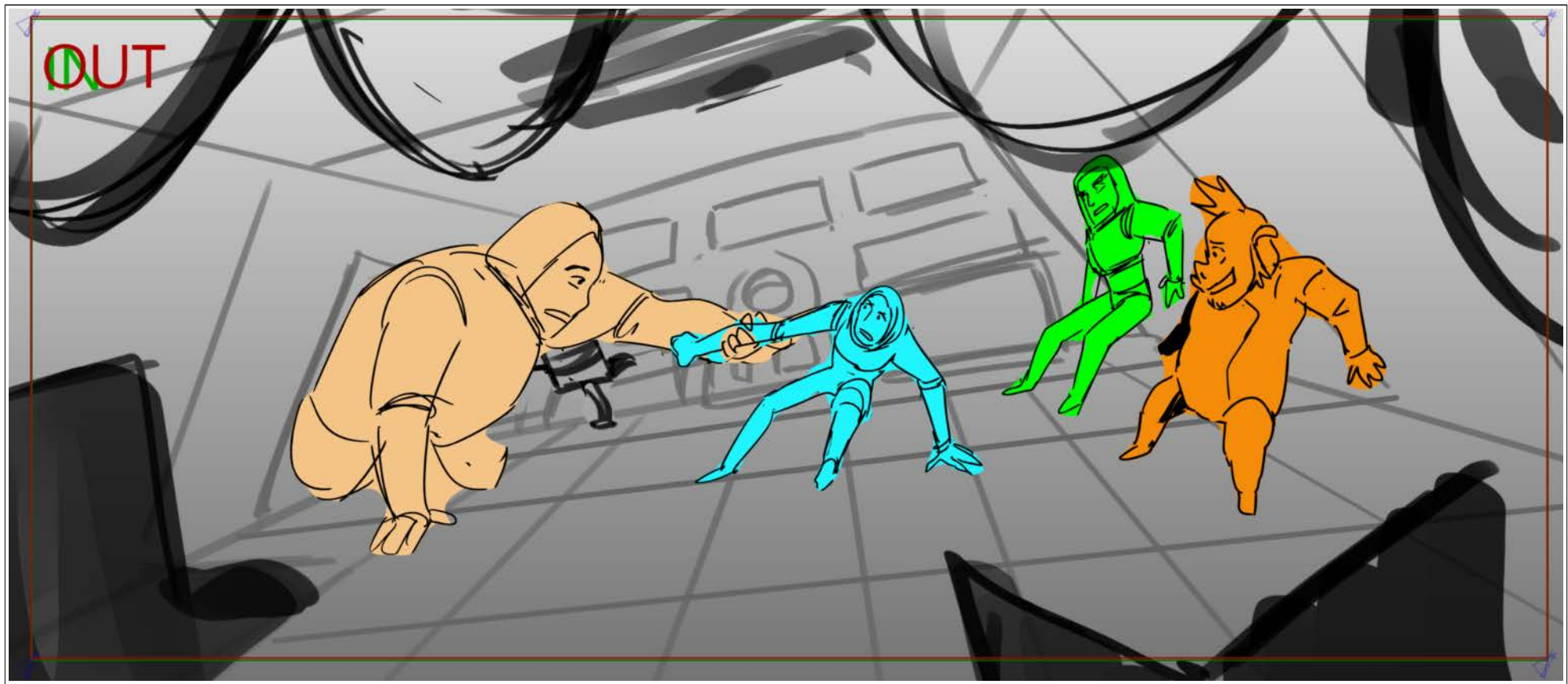

Scene	Duration	Panel	Duration
200	02:15	02B	00:11

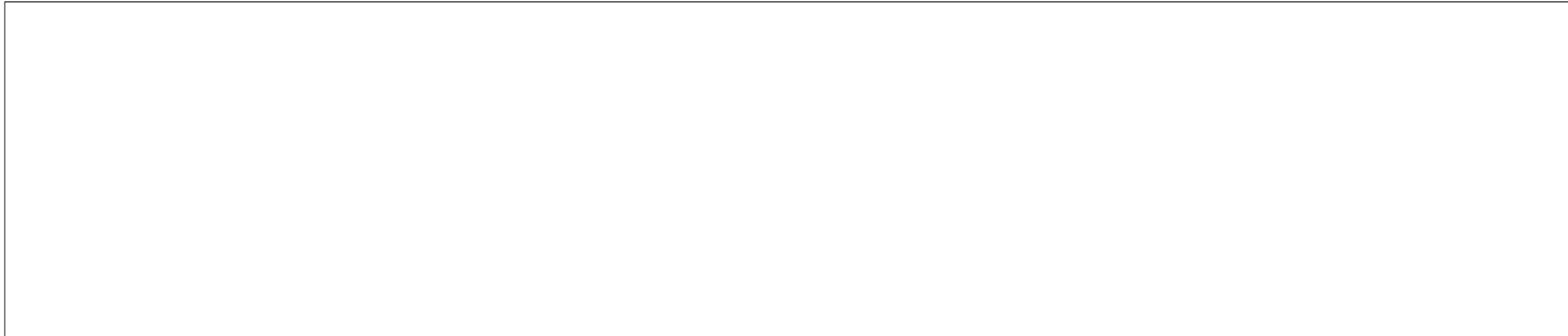
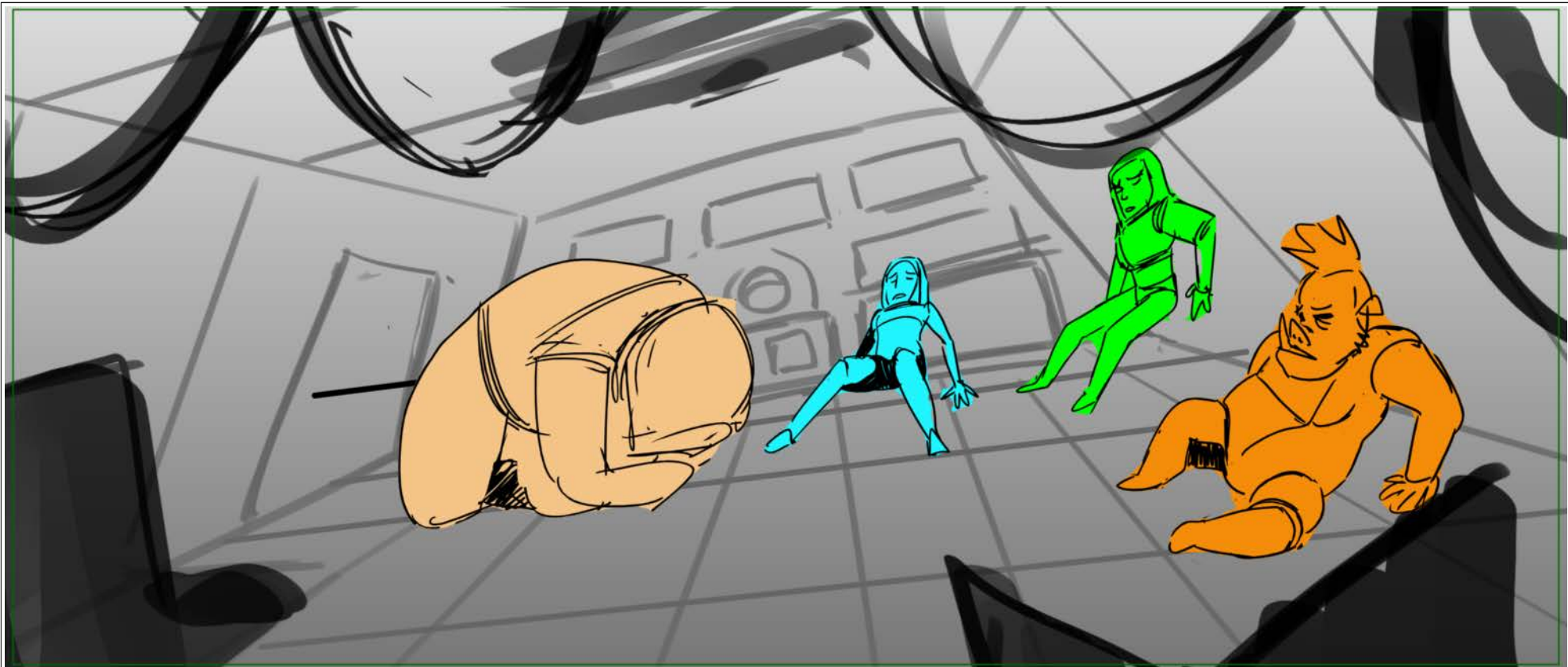

Scene	Duration	Panel	Duration
205	02:01	001	00:16

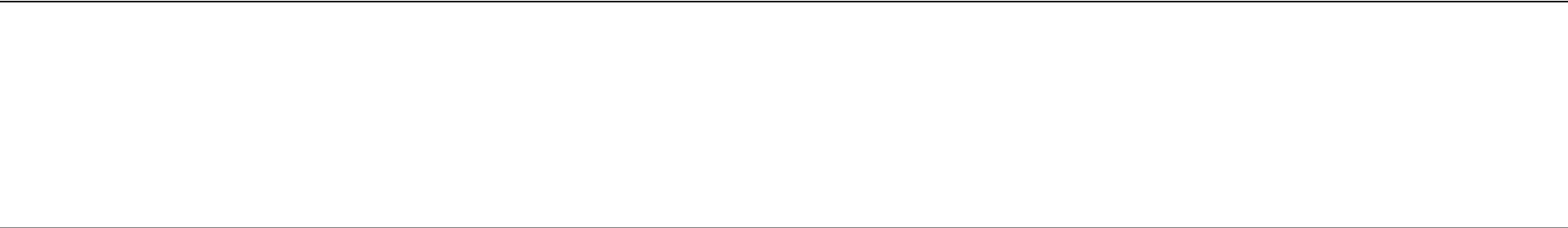
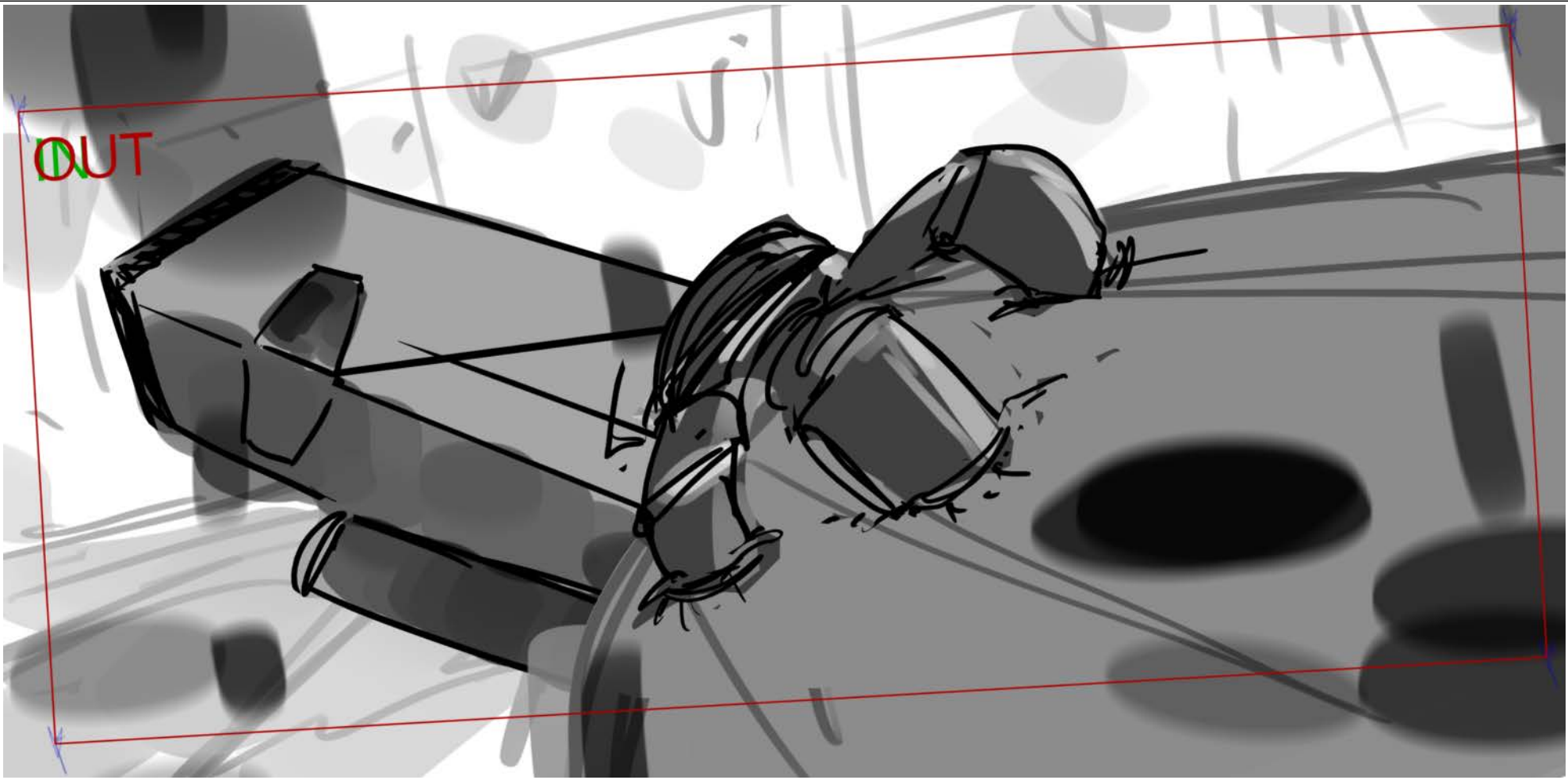

Scene	Duration	Panel	Duration
205	02:01	001A	00:14

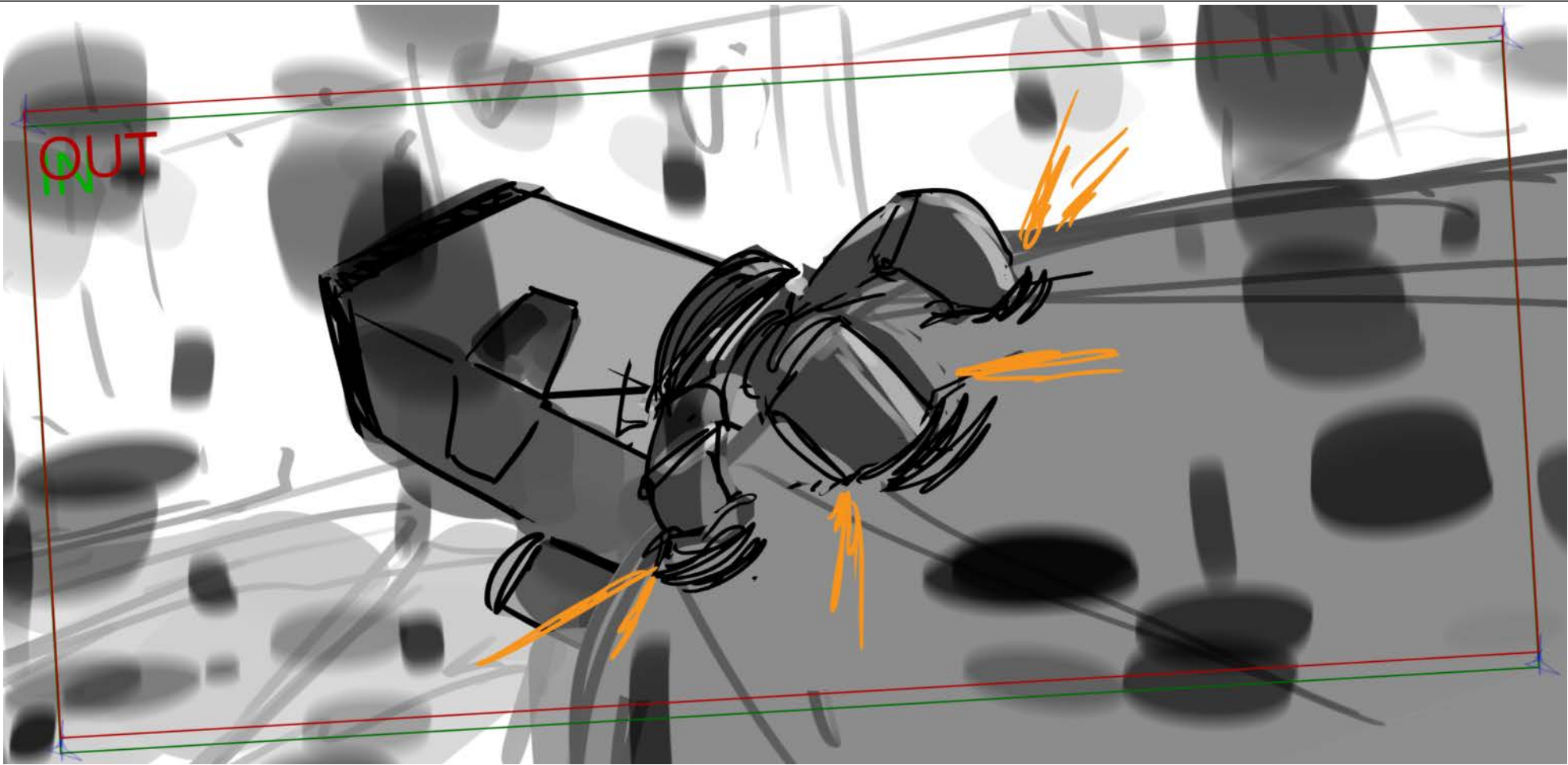

Scene	Duration	Panel	Duration
205	02:01	001B	00:19

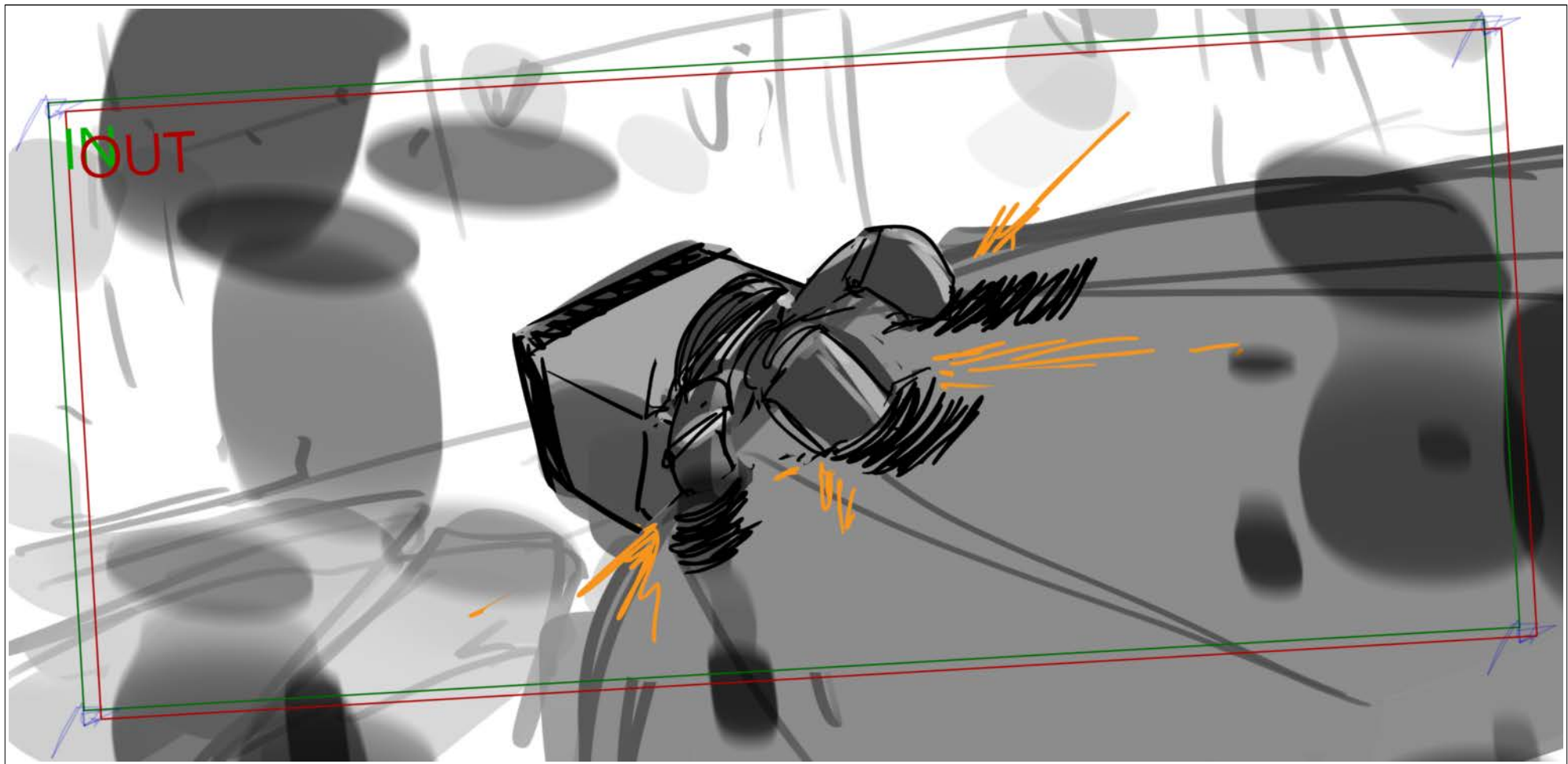

Scene	Duration	Panel	Duration
240	02:06	001A2	00:04

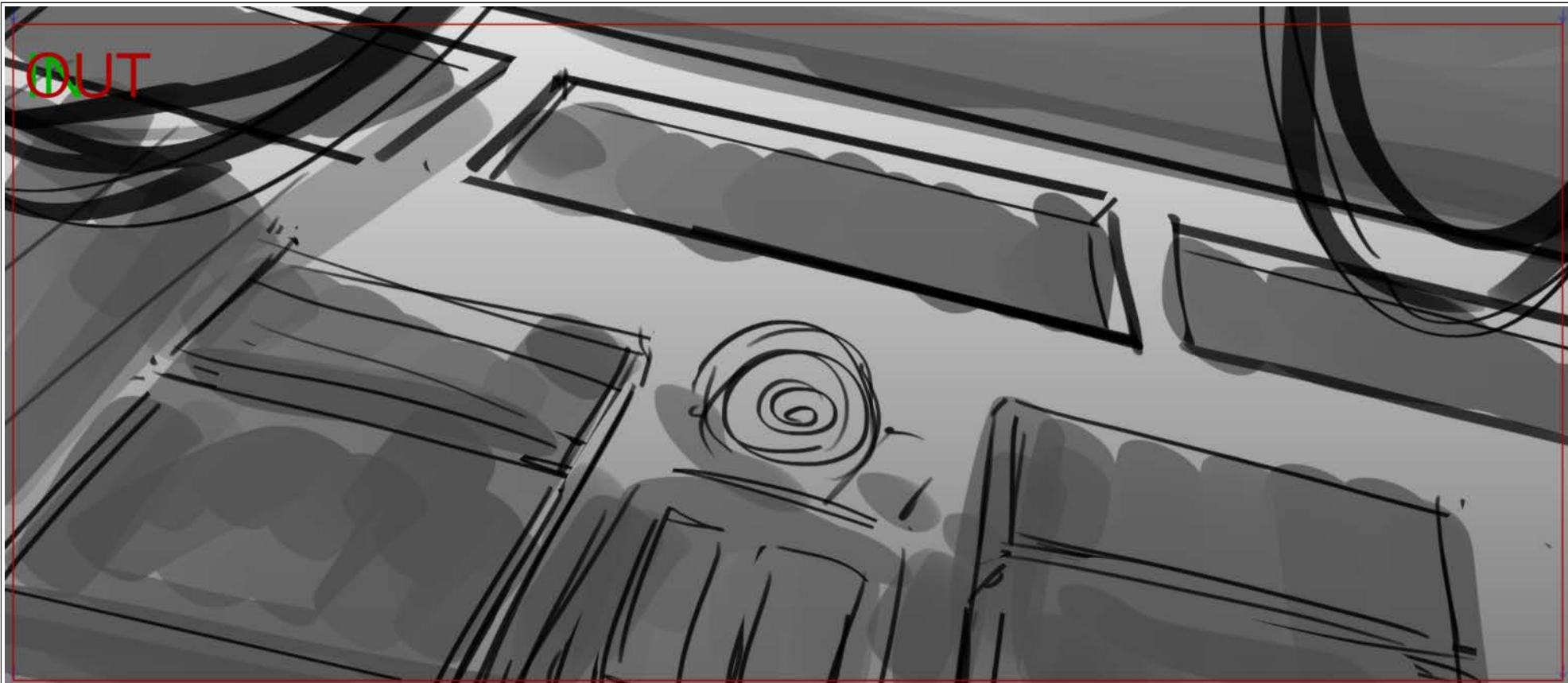

Dialog

ENSIGN GARROVICK (RECORDING)

184 ?This is Ensign Garrovick of the USS Enterprise.

Action Notes

LIGHTS FLICKER, TRANSMISSIONS STARTS

Scene	Duration	Panel	Duration
240	02:06	001	00:03

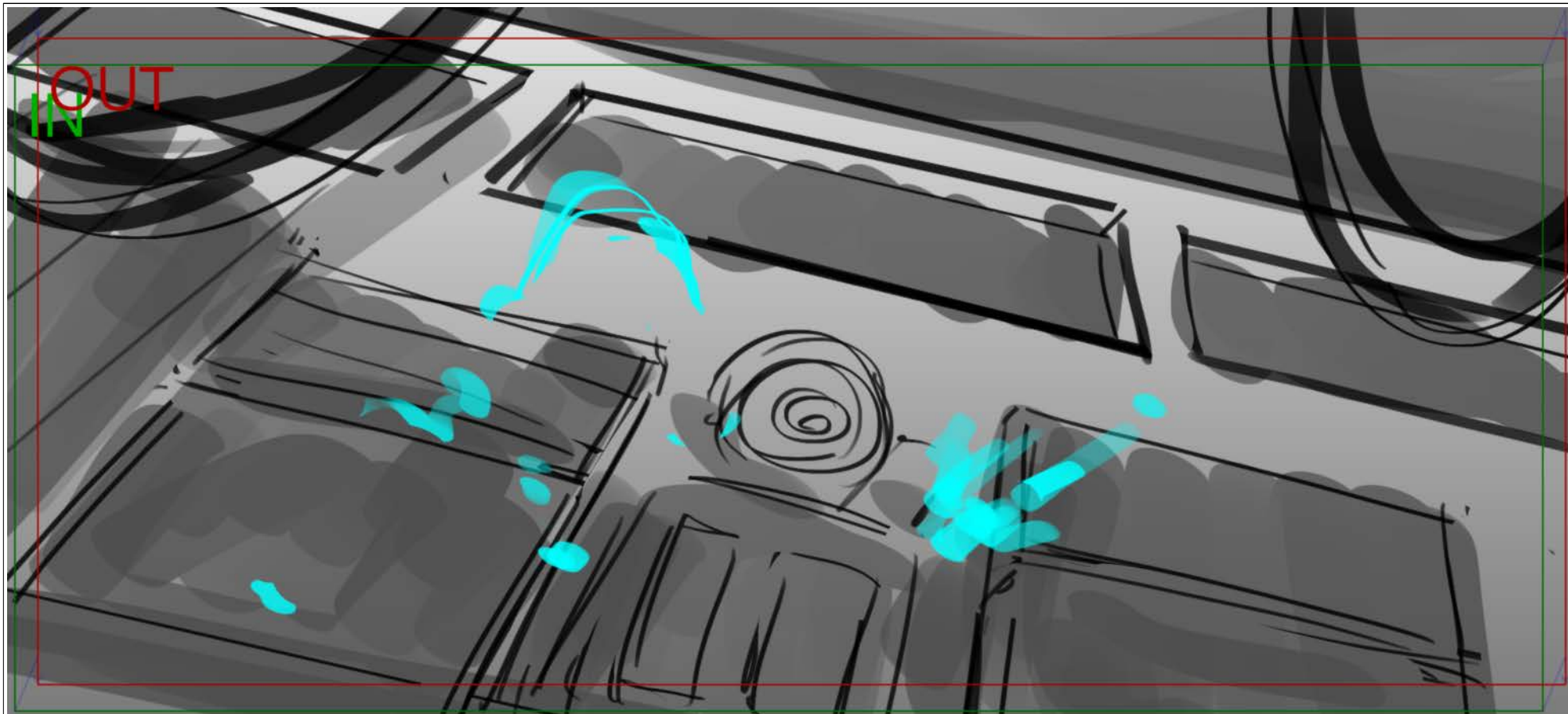

Dialog

ENSIGN GARROVICK (RECORDING)

184 ?This is Ensign Garrovick of the USS Enterprise.

Action Notes

LIGHTS FLICKER, TRANSMISSIONS STARTS

Scene	Duration	Panel	Duration
240	02:06	001A0	00:02

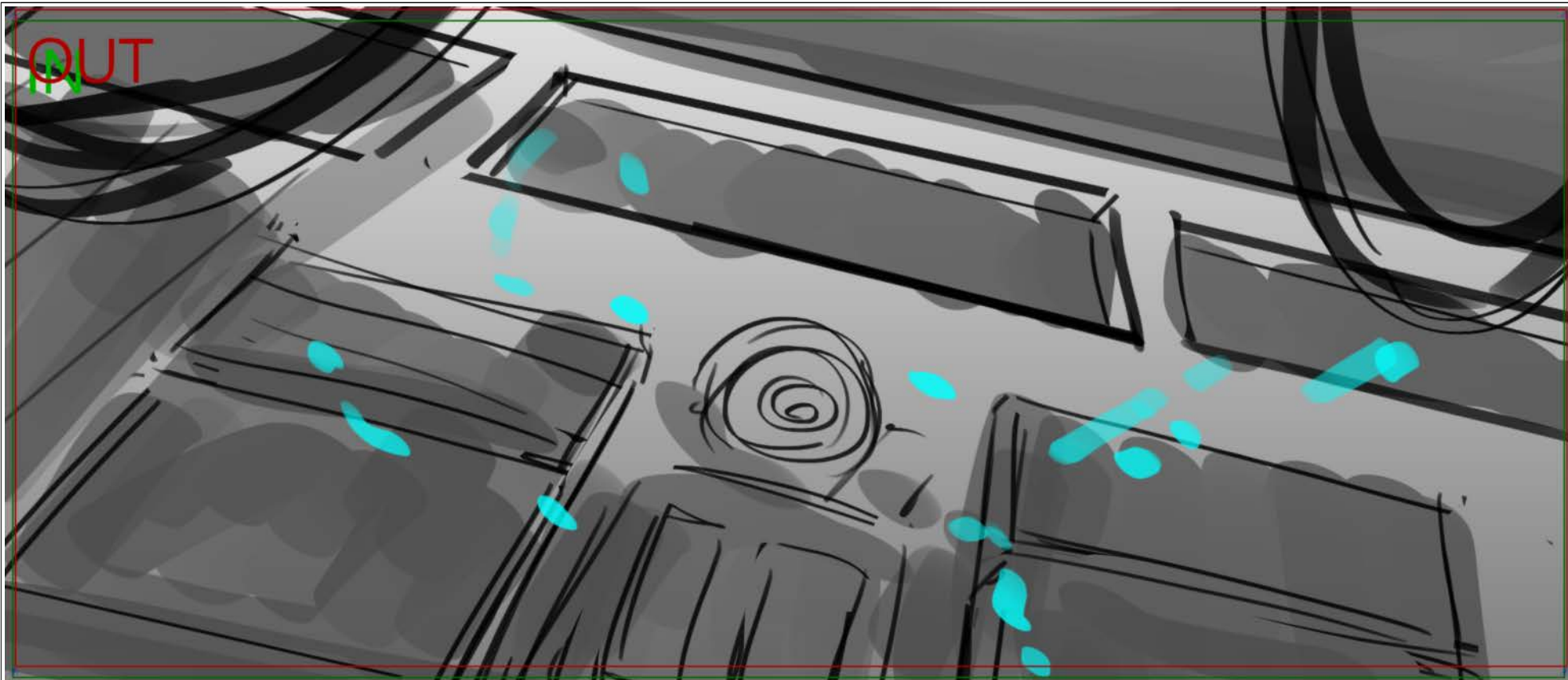

Dialog

ENSIGN GARROVICK (RECORDING)

184 ?This is Ensign Garrovick of the USS Enterprise.

Action Notes

LIGHTS FLICKER, TRANSMISSIONS STARTS

Scene	Duration	Panel	Duration
240	02:06	001A1	00:07

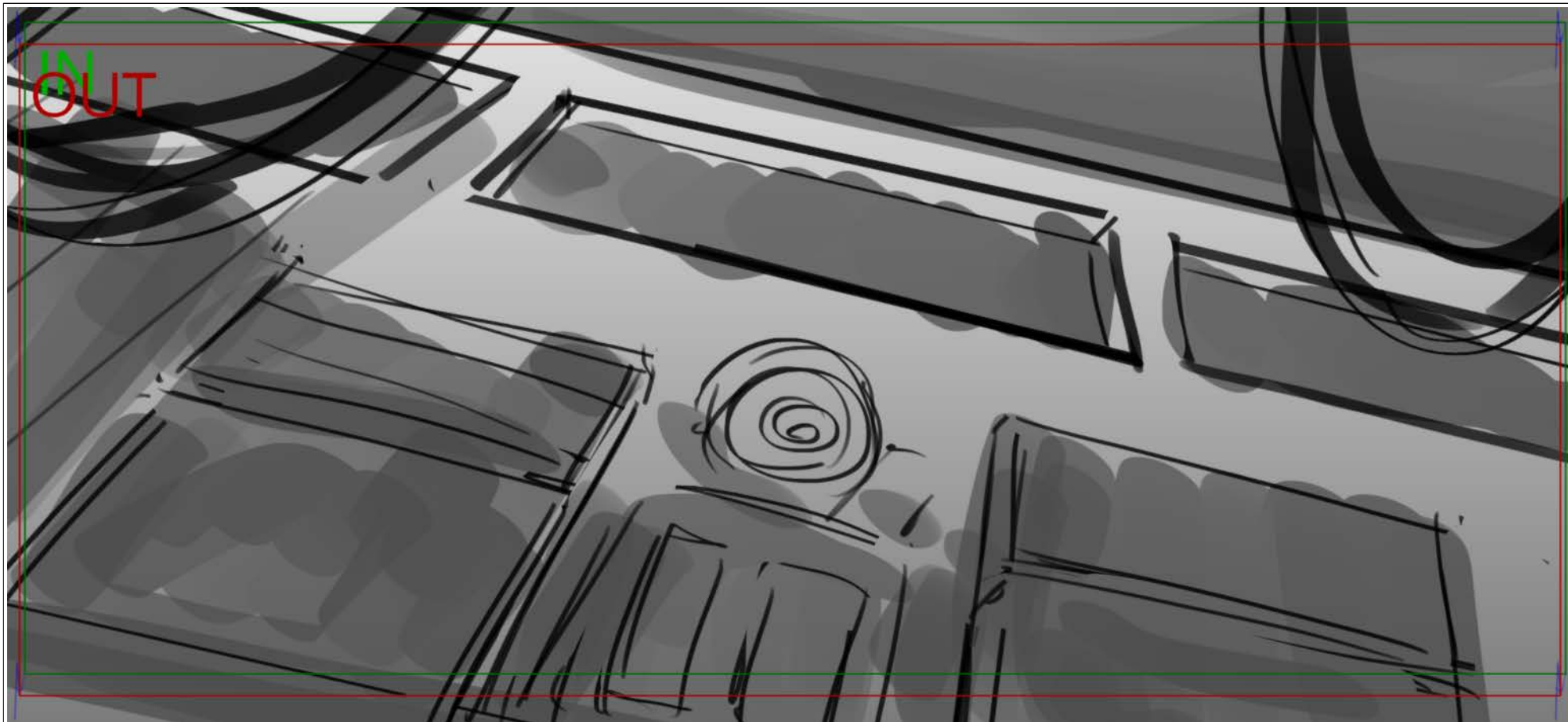

Dialog

ENSIGN GARROVICK (RECORDING)

184 ?This is Ensign Garrovick of the USS Enterprise.

Action Notes

LIGHTS FLICKER, TRANSMISSIONS STARTS

Scene	Duration	Panel	Duration
240	02:06	001I	00:02

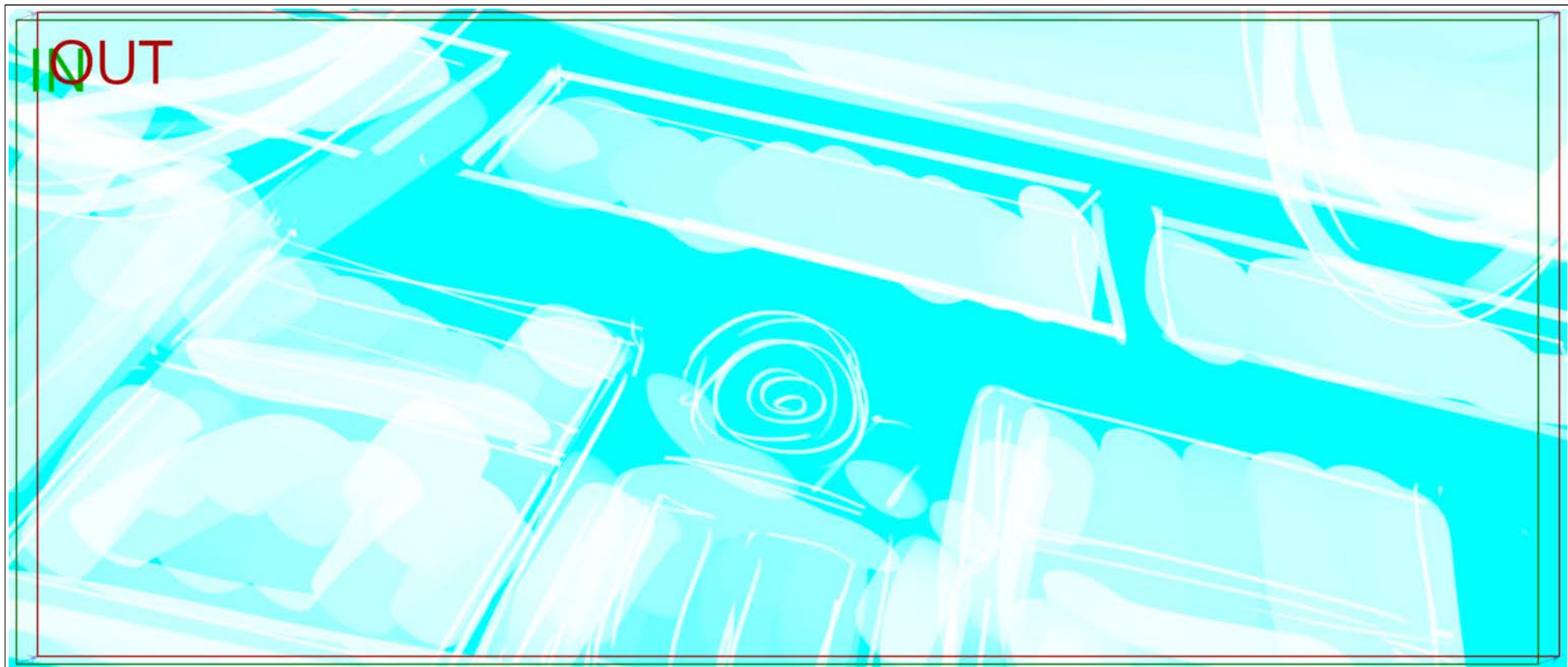

Dialog

ENSIGN GARROVICK (RECORDING)

184 ?This is Ensign Garrovick of the USS Enterprise.

Scene	Duration	Panel	Duration
240	02:06	001A	00:02

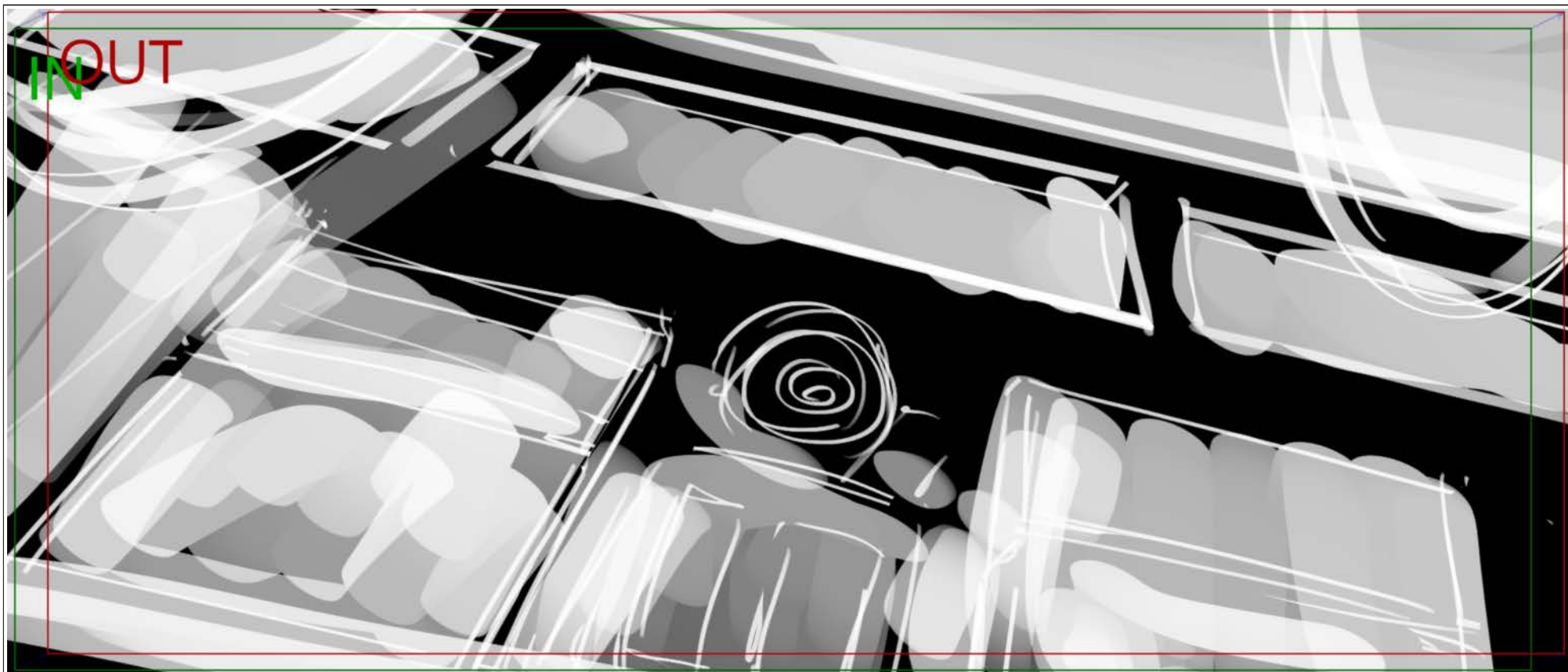

Dialog

ENSIGN GARROVICK (RECORDING)

184 ?This is Ensign Garrovick of the USS Enterprise.

Scene	Duration	Panel	Duration
240	02:06	001A3	00:07

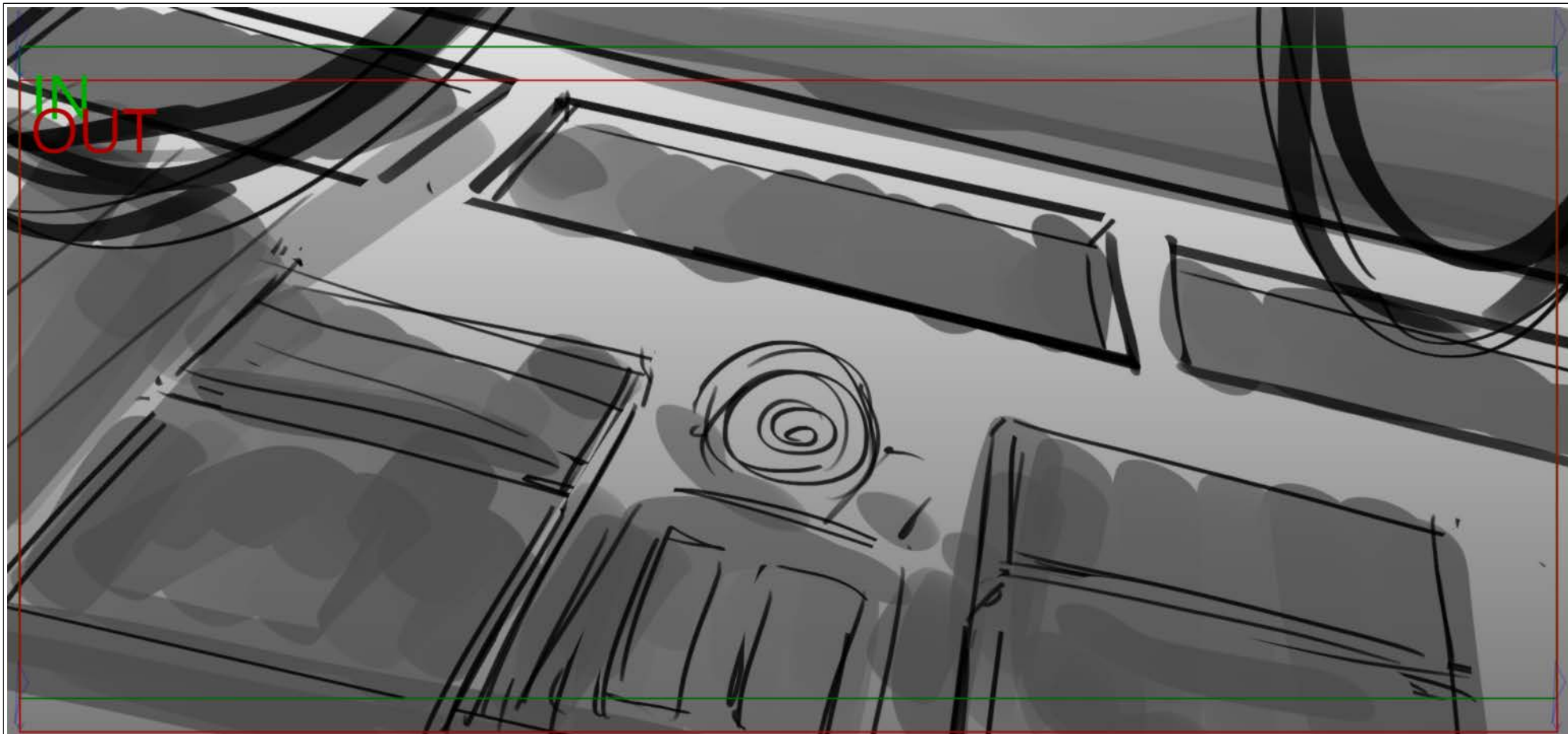

Dialog

ENSIGN GARROVICK (RECORDING)

184 ?This is Ensign Garrovick of the USS Enterprise.

Action Notes

LIGHTS FLICKER, TRANSMISSIONS STARTS

Scene	Duration	Panel	Duration
240	02:06	001A4	00:02

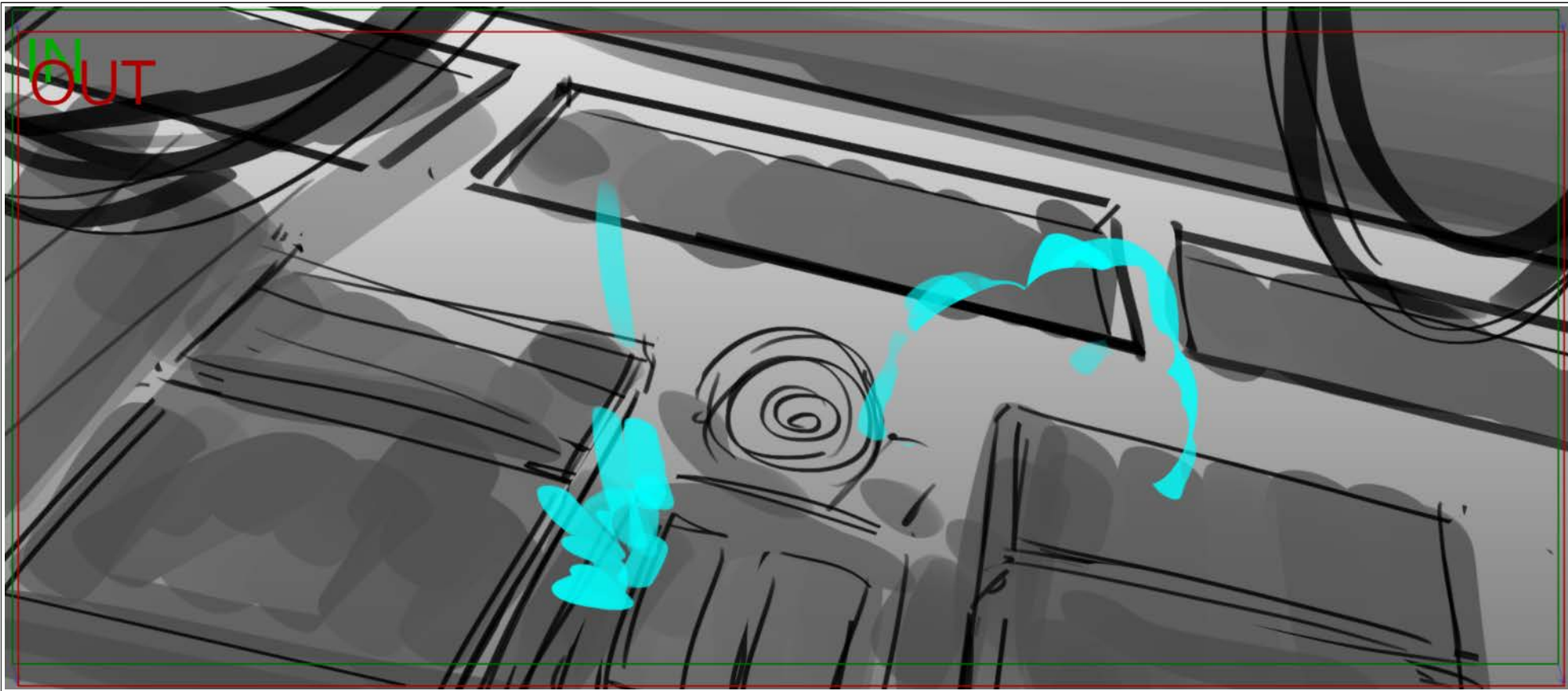

Dialog

ENSIGN GARROVICK (RECORDING)

184 ?This is Ensign Garrovick of the USS Enterprise.aaaaaa

Action Notes

LIGHTS FLICKER, TRANSMISSIONS STARTS

Scene	Duration	Panel	Duration
240	02:06	001A5	00:01

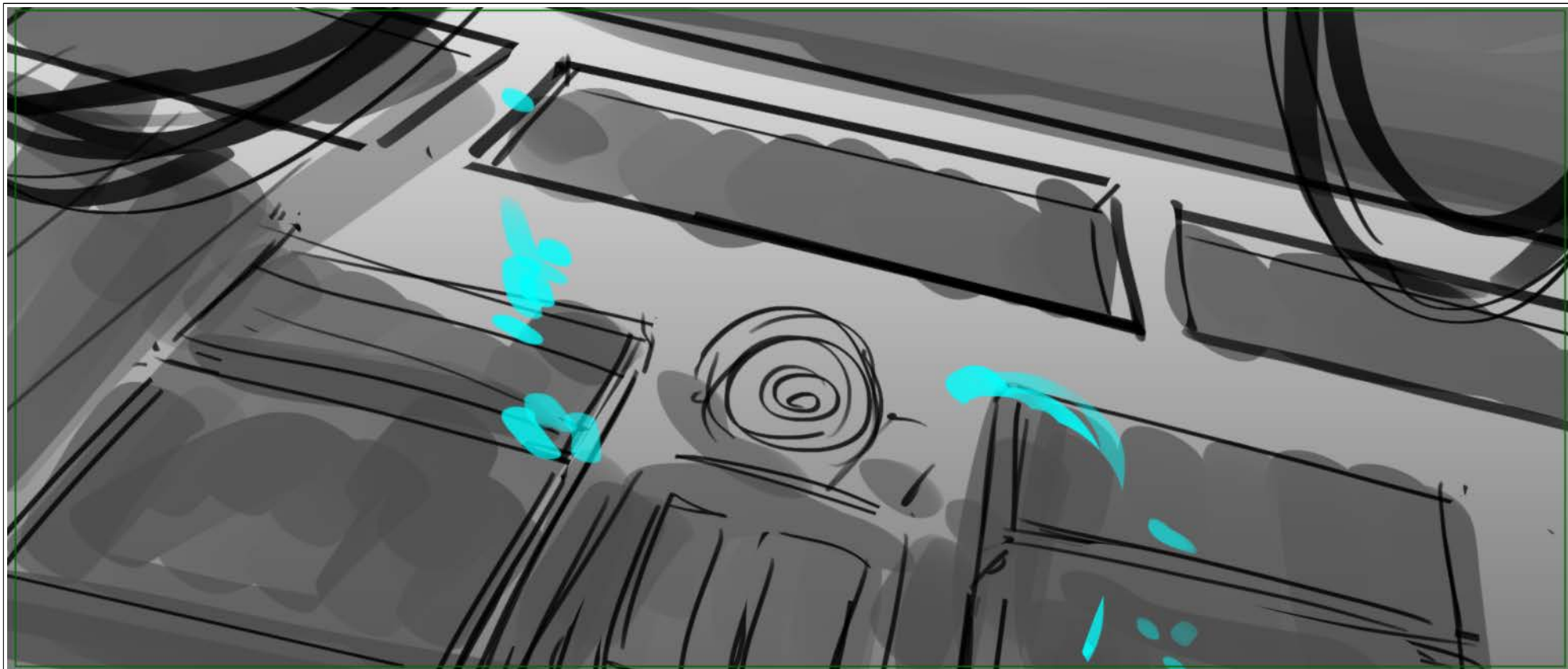

Action Notes

LIGHTS FLICKER, TRANSMISSIONS STARTS

Scene	Duration	Panel	Duration
240	02:06	001A6	00:04

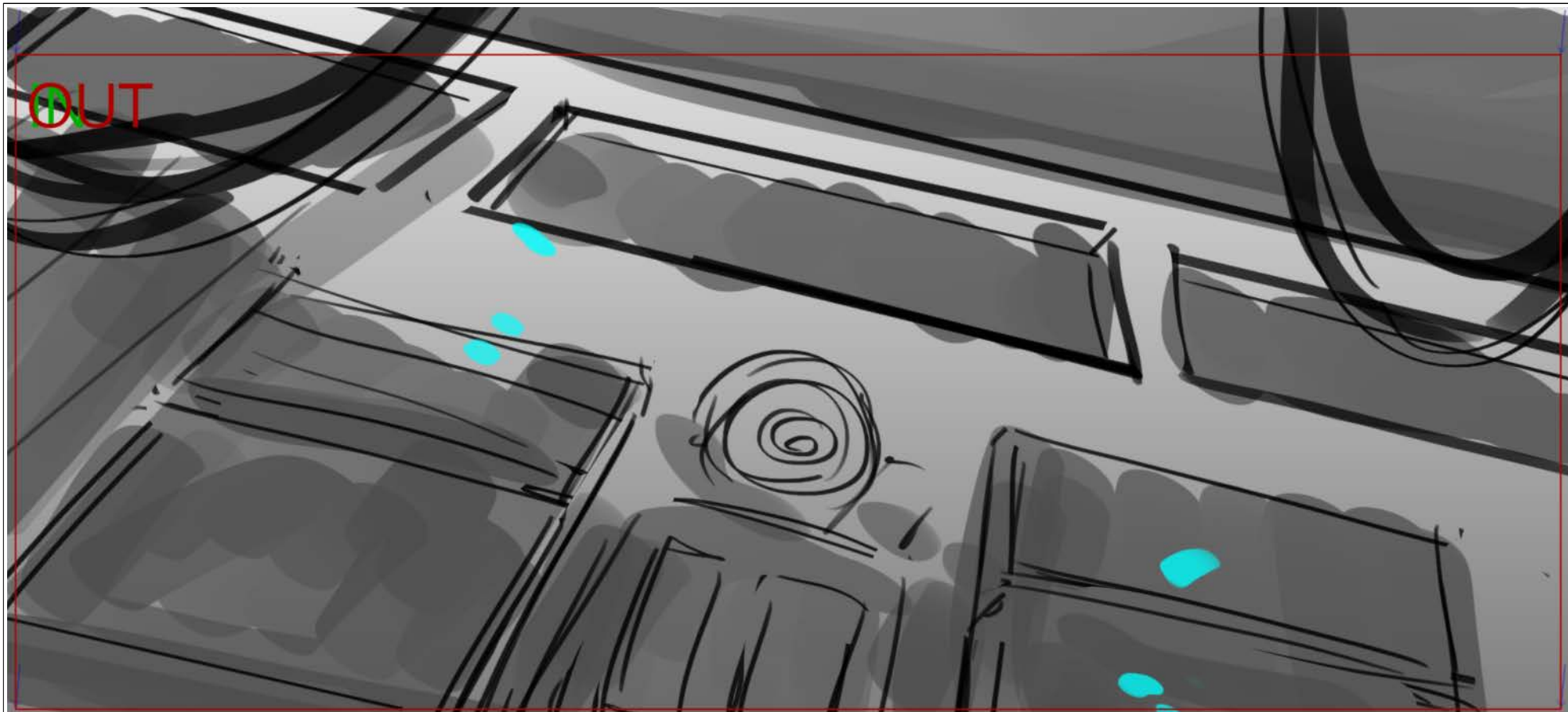

Action Notes

LIGHTS FLICKER, TRANSMISSIONS STARTS

Scene	Duration	Panel	Duration
240	02:06	001A7	00:04

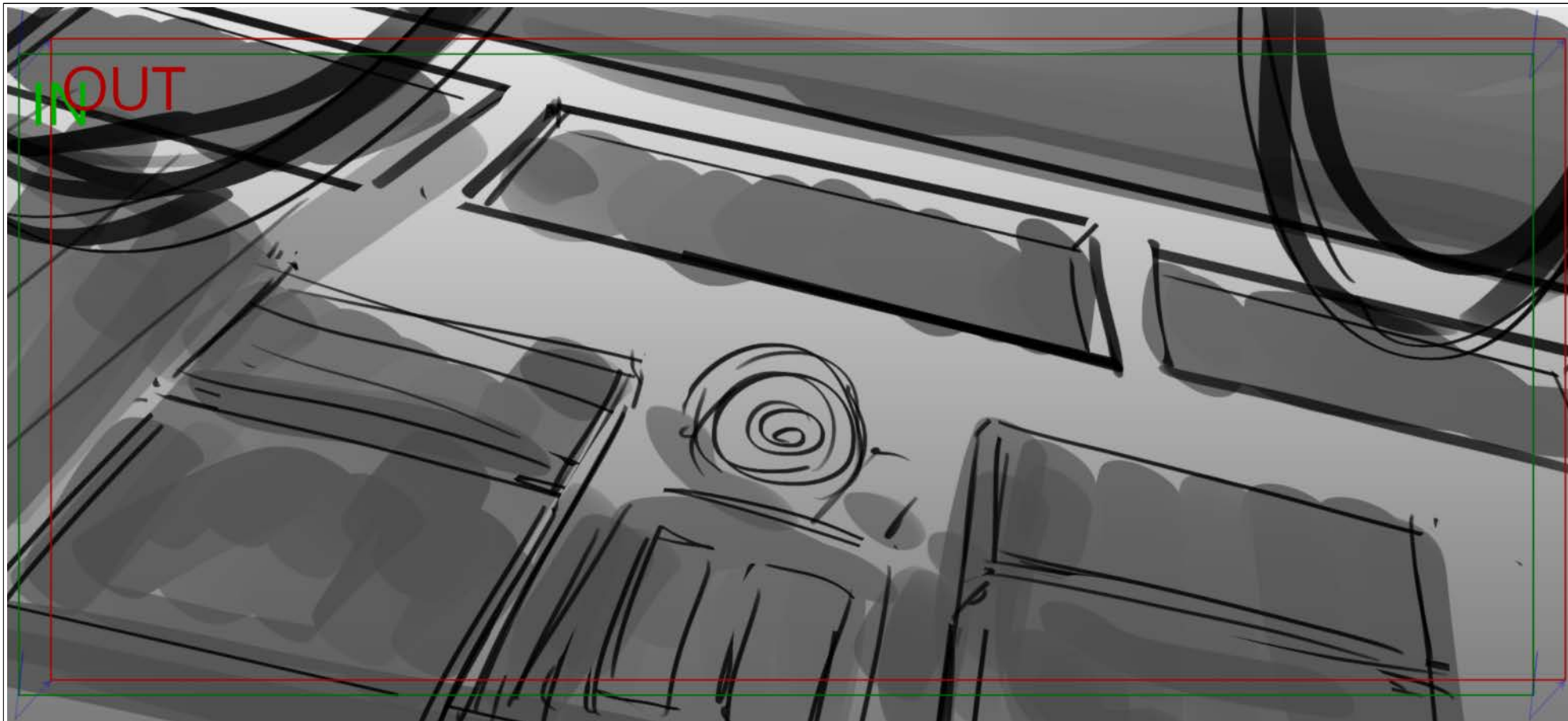

Action Notes

LIGHTS FLICKER, TRANSMISSIONS STARTS

Scene	Duration	Panel	Duration
240	02:06	001E	00:02

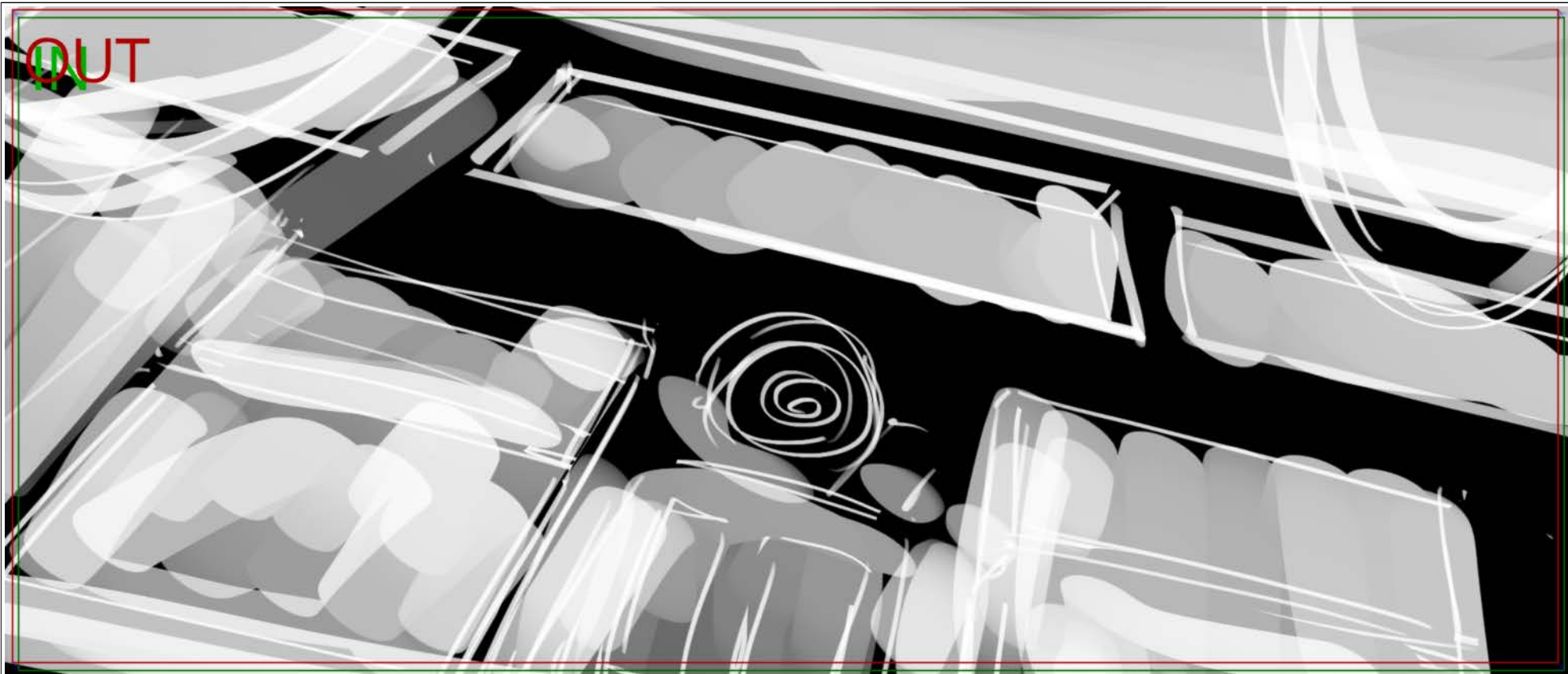

Dialog

ENSIGN GARROVICK (RECORDING)

184 ?This is Ensign Garrovick of the USS Enterprise.

Scene	Duration	Panel	Duration
240	02:06	001G	00:02

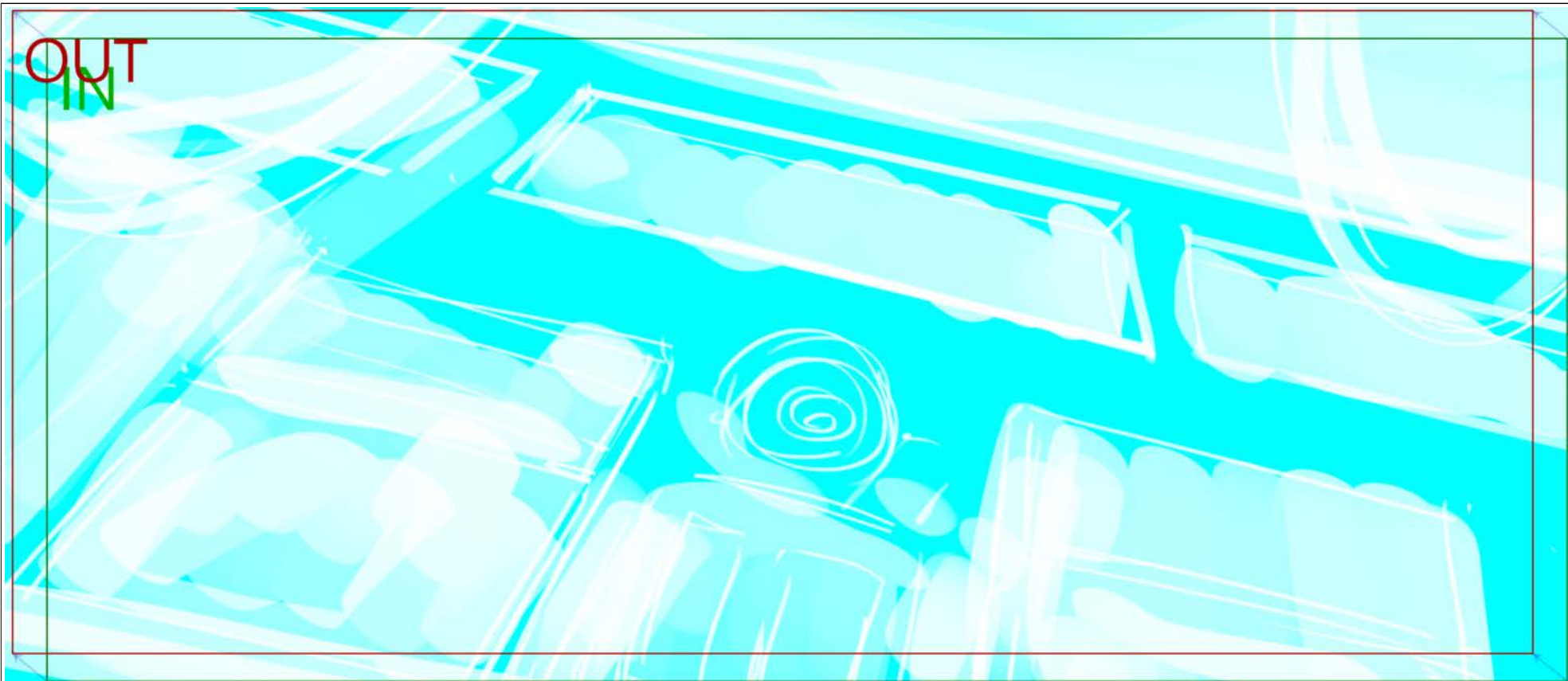

Dialog

ENSIGN GARROVICK (RECORDING)

184 ?This is Ensign Garrovick of the USS Enterprise.

Scene	Duration	Panel	Duration
240	02:06	001A8	00:04

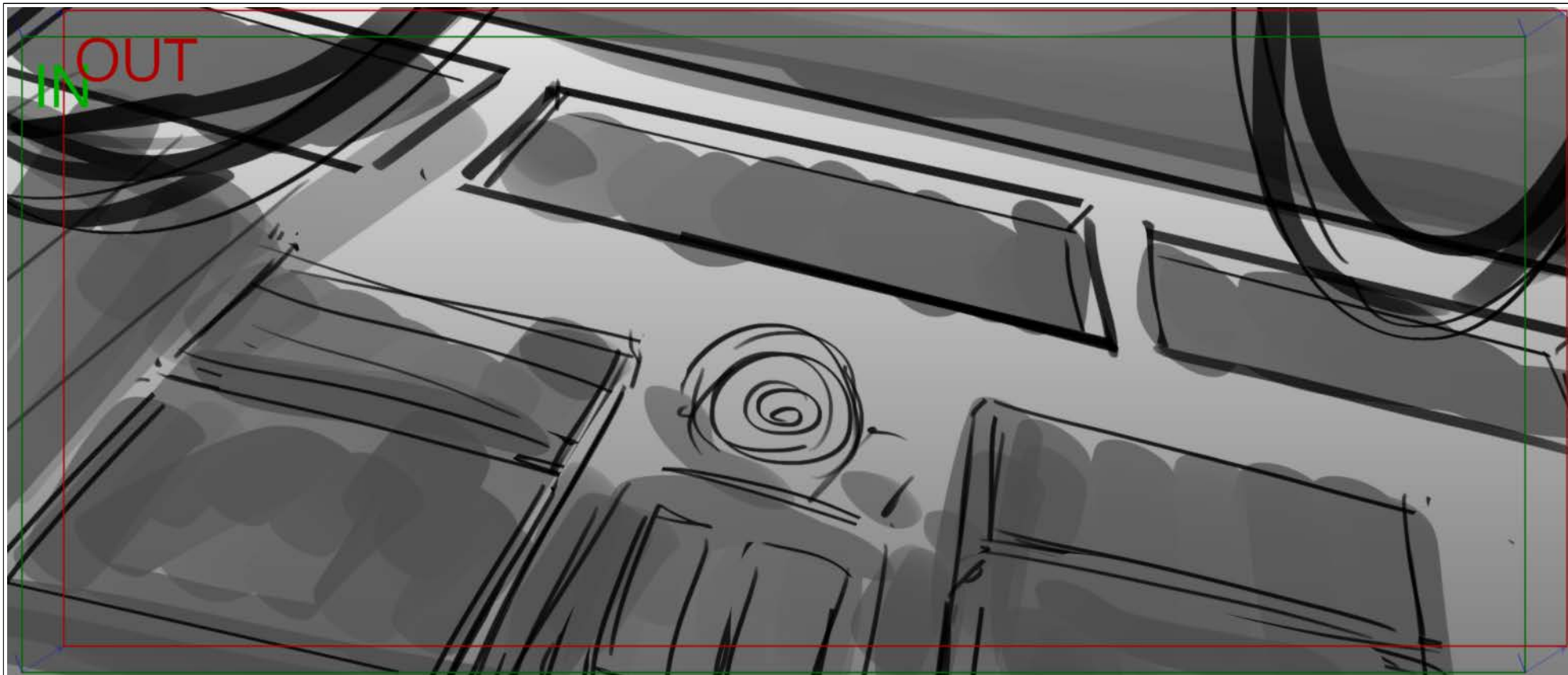

Action Notes

LIGHTS FLICKER, TRANSMISSIONS STARTS

Scene	Duration	Panel	Duration
240	02:06	001F	00:02

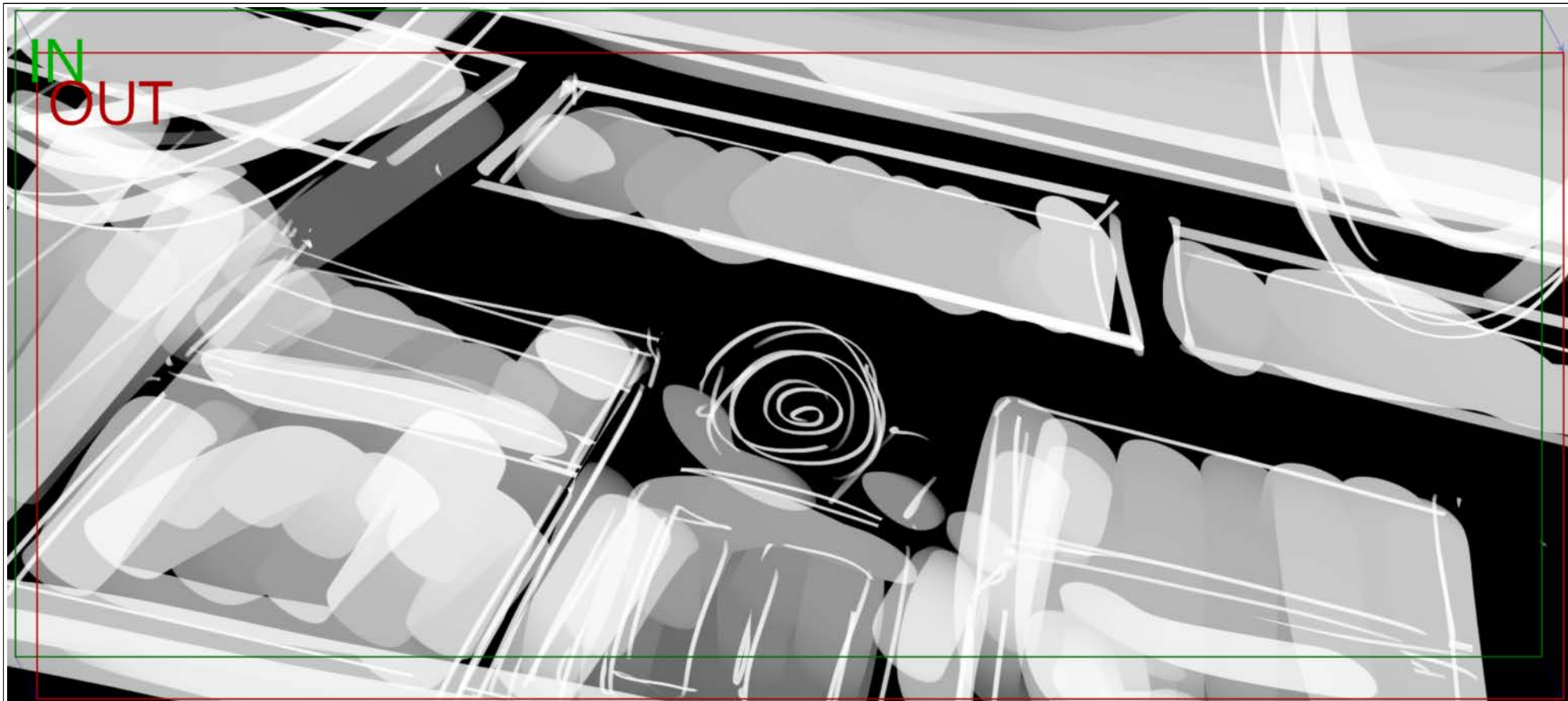

Dialog

ENSIGN GARROVICK (RECORDING)

184 ?This is Ensign Garrovick of the USS Enterprise.

Scene	Duration	Panel	Duration
240	02:06	001H	00:02

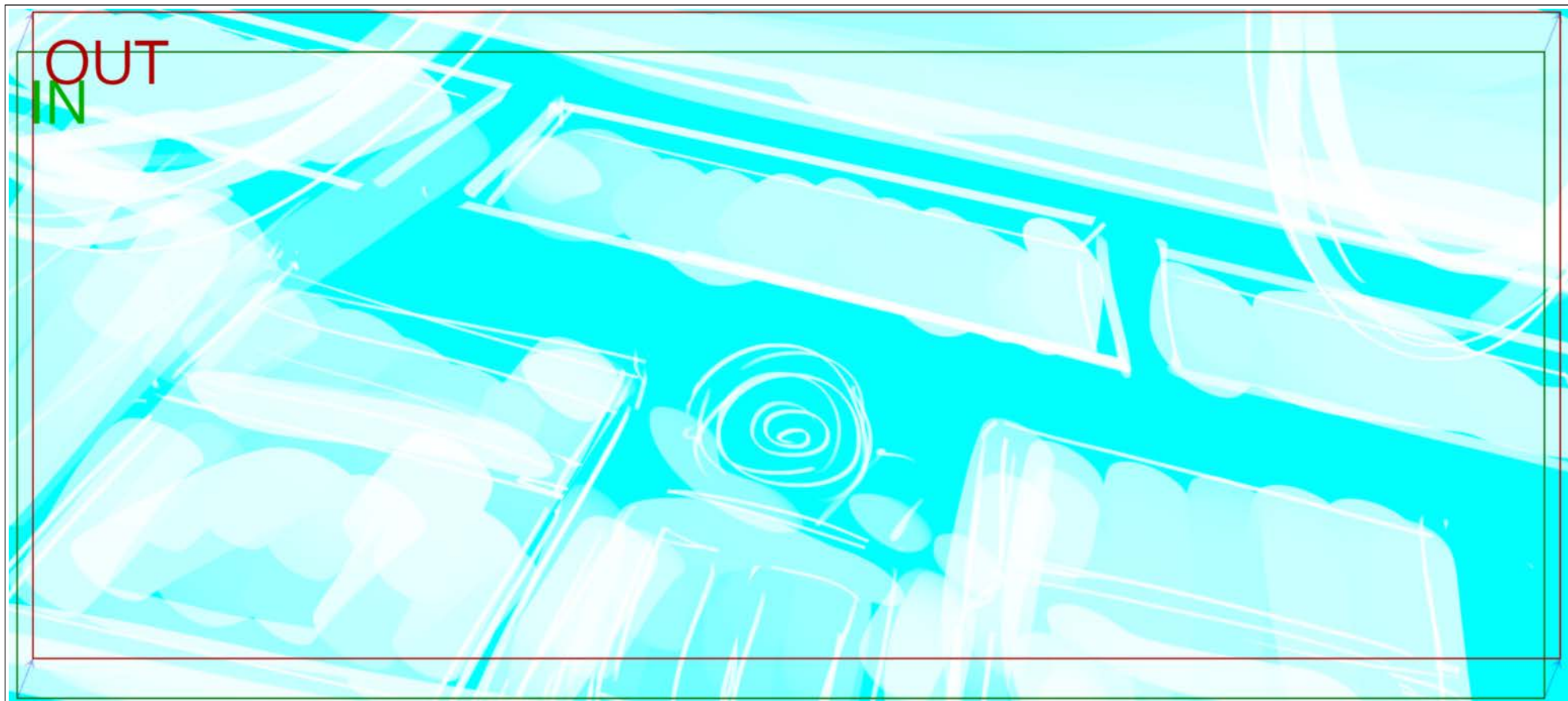

Dialog

ENSIGN GARROVICK (RECORDING)

184 ?This is Ensign Garrovick of the USS Enterprise.

Scene	Duration	Panel	Duration
240	02:06	001A9	00:04

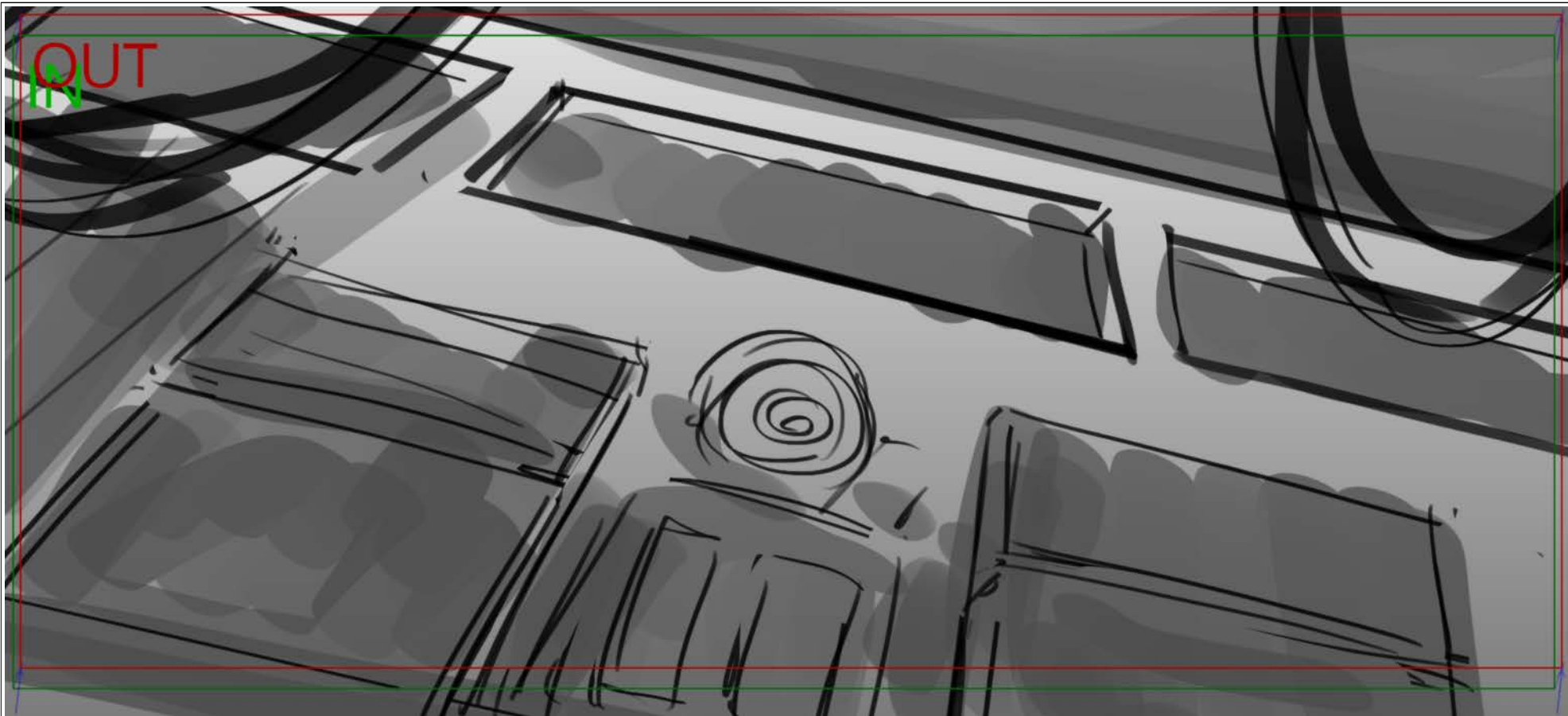

Action Notes

LIGHTS FLICKER, TRANSMISSIONS STARTS

Scene	Duration	Panel	Duration
250	00:19	001	00:19



Dialog

This'll be my final call to Starfleet hoping you'll come...

Scene	Duration	Panel	Duration
260	01:00	001	01:00

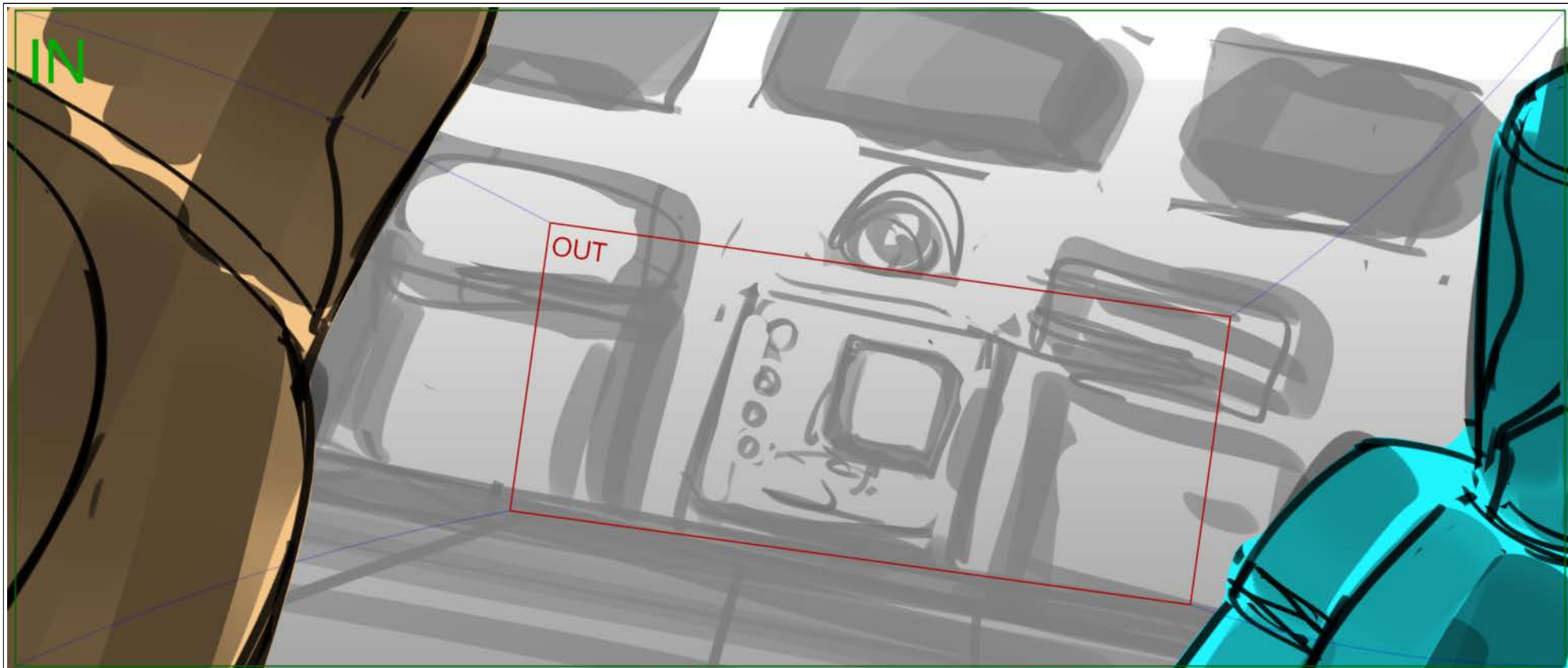

Dialog
though I've long given up that anyone'll hear it. Heh.

Scene	Duration	Panel	Duration
270	01:05	001	00:09

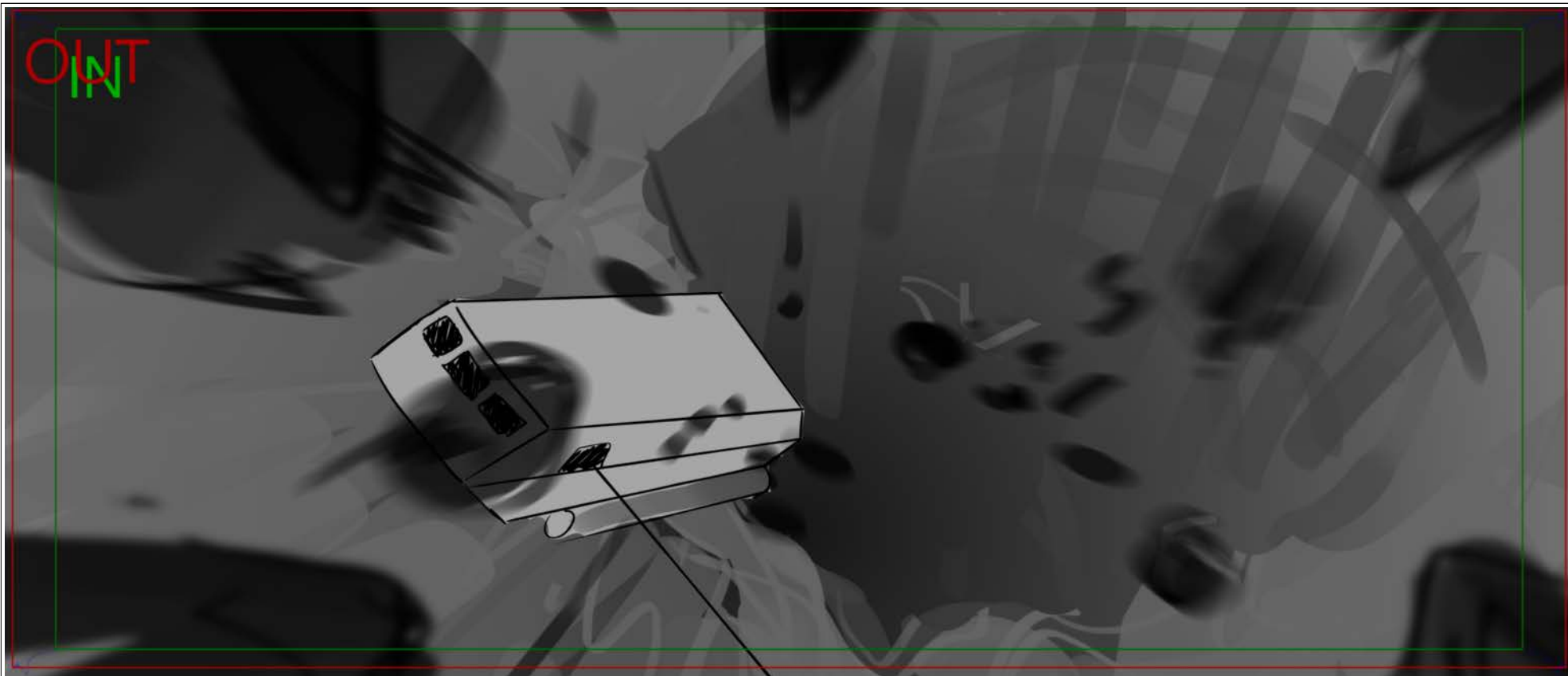

Dialog

Hope?s a funny thing, isn?t it...??

Scene	Duration	Panel	Duration
270	01:05	002	00:08

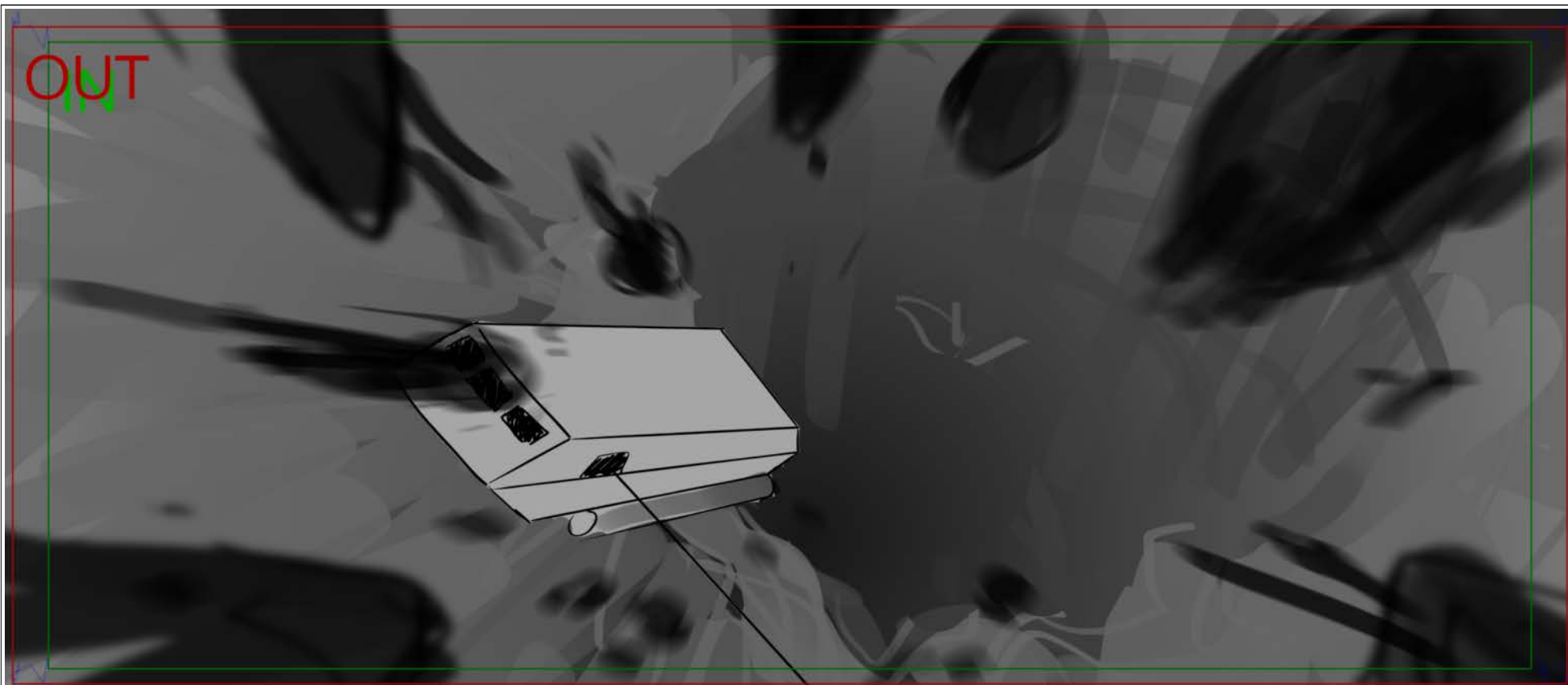

Dialog

Hope?s a funny thing, isn?t it...??

Scene	Duration	Panel	Duration
270	01:05	003	00:07

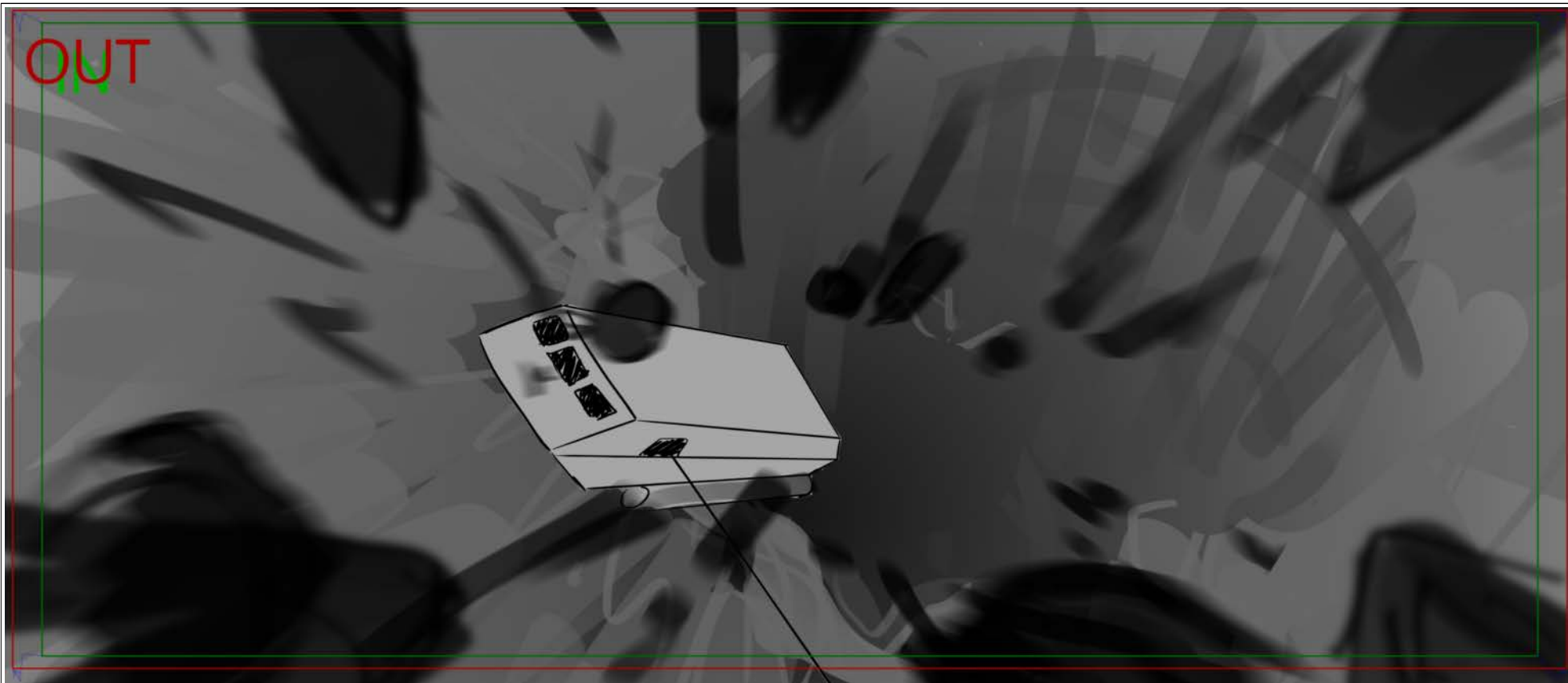

Dialog

Hope?s a funny thing, isn?t it...??

Scene	Duration	Panel	Duration
270	01:05	004	00:05



Dialog

Hope?s a funny thing, isn?t it...??

Scene	Duration	Panel	Duration
280	04:00	001B	01:00

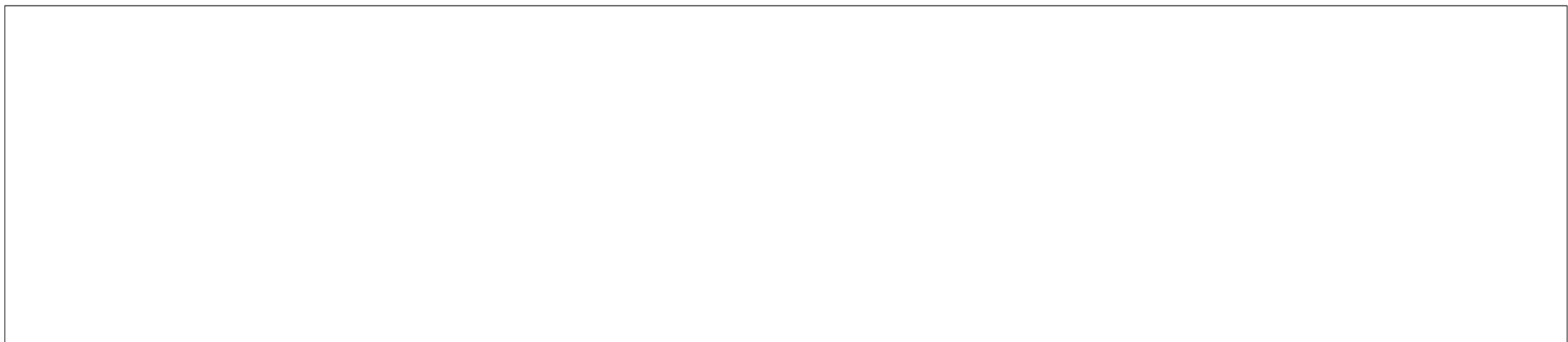
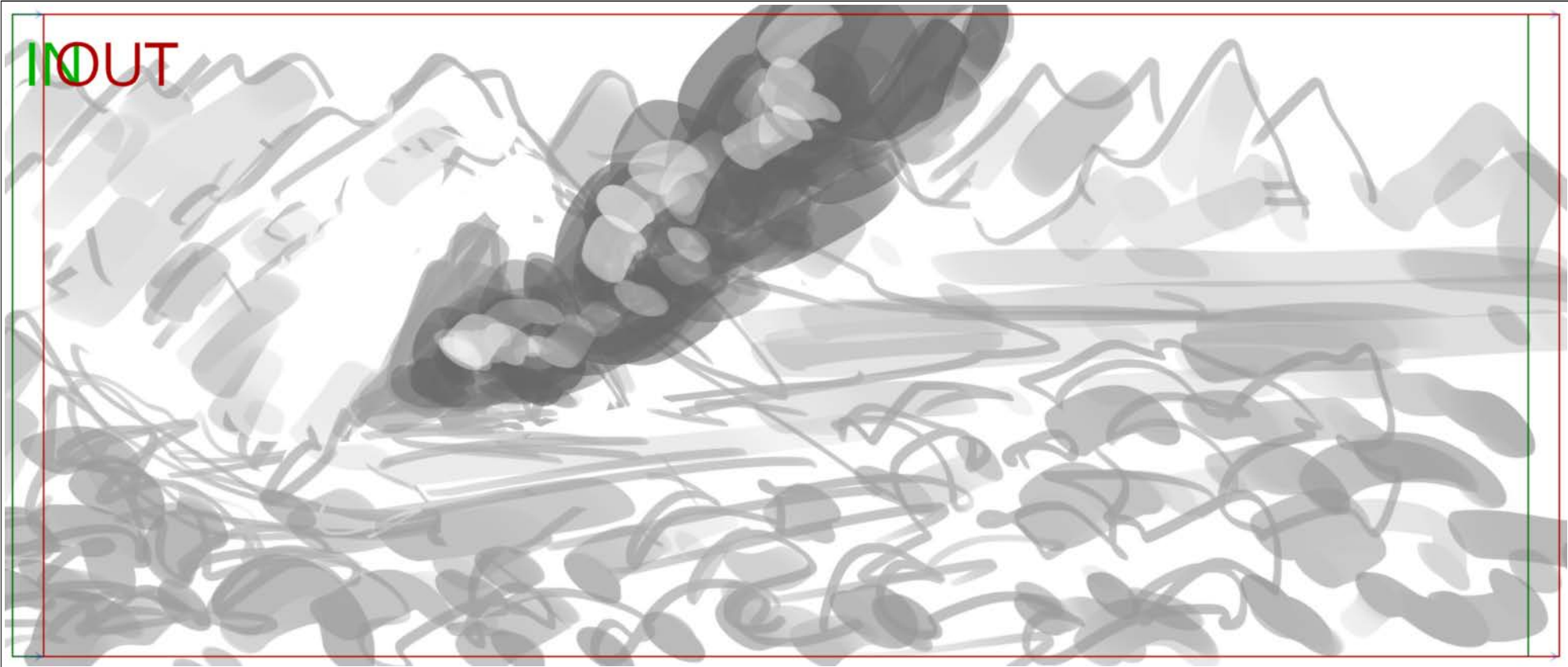

Scene	Duration	Panel	Duration
280	04:00	001E	01:00

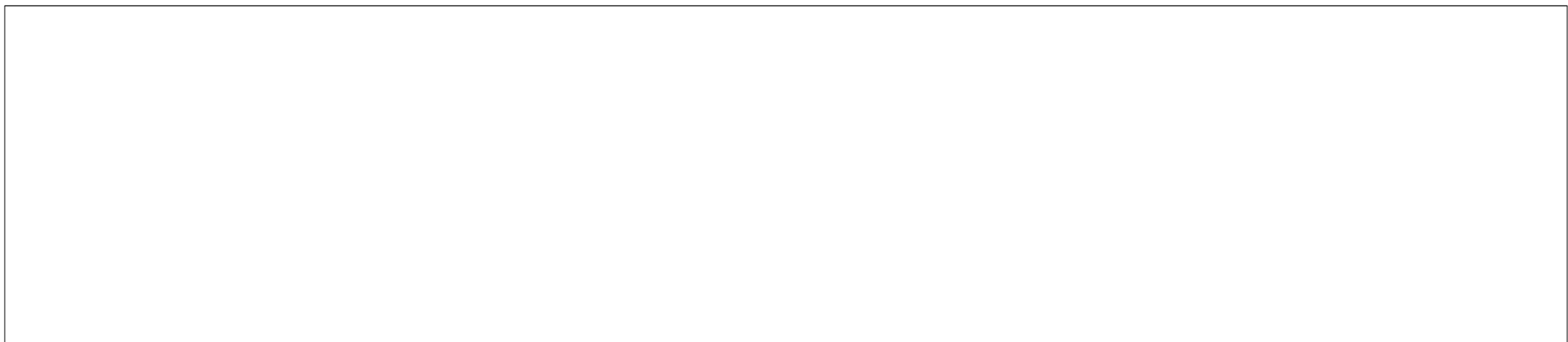
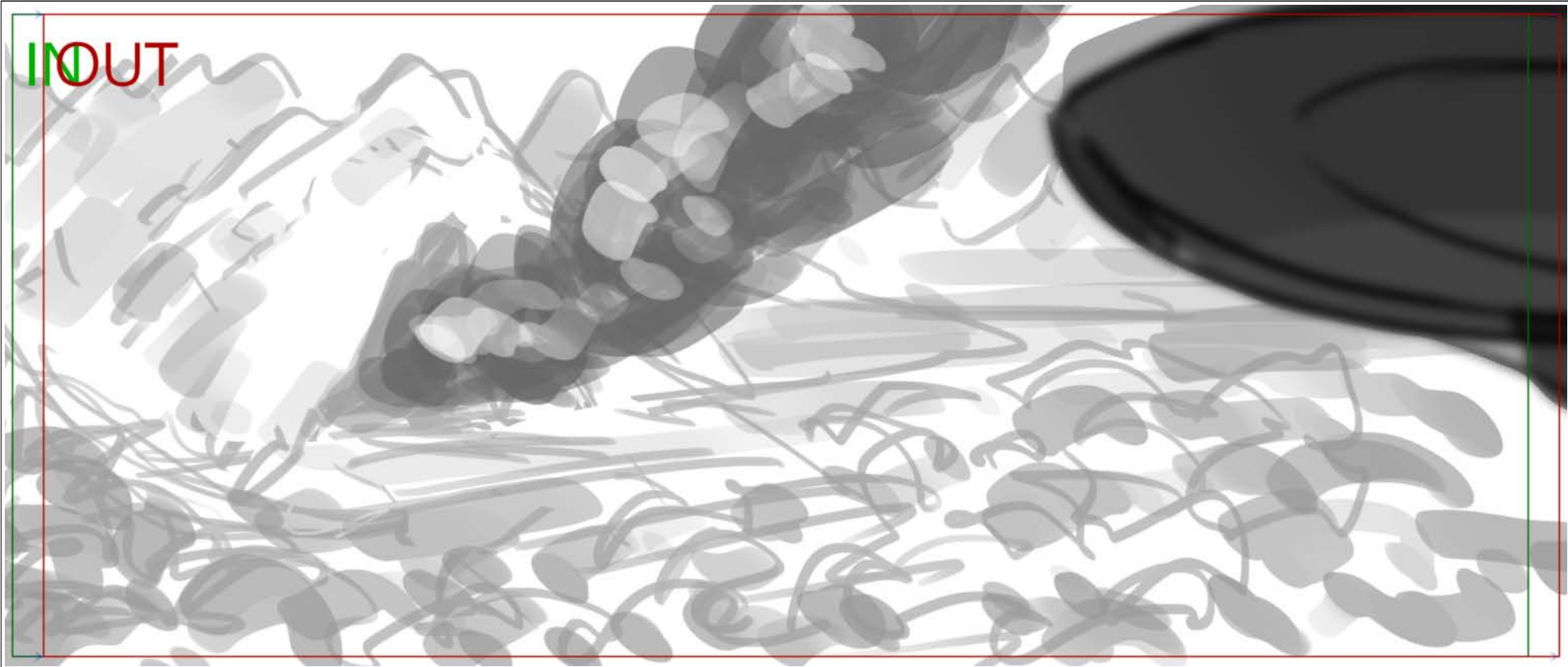

Scene	Duration	Panel	Duration
280	04:00	001D	01:00

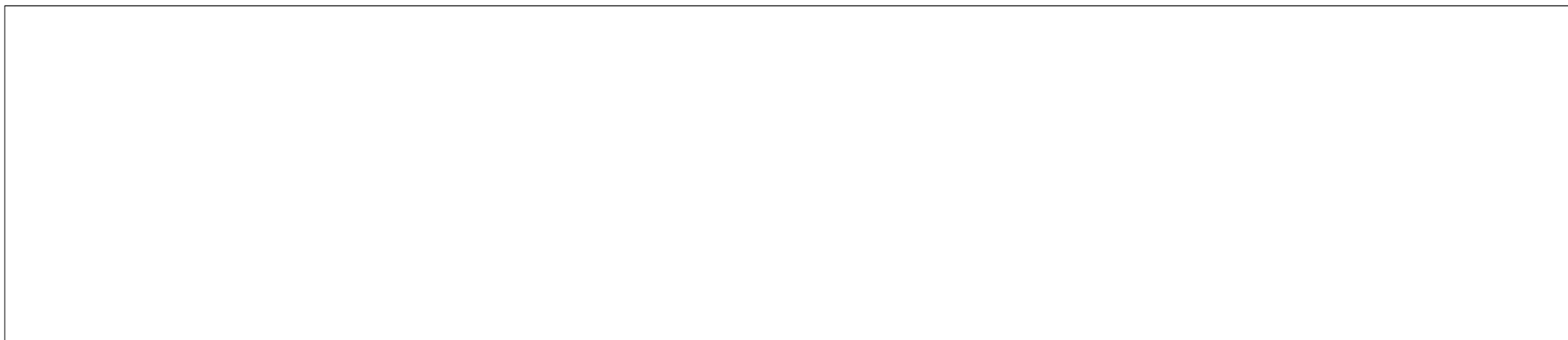
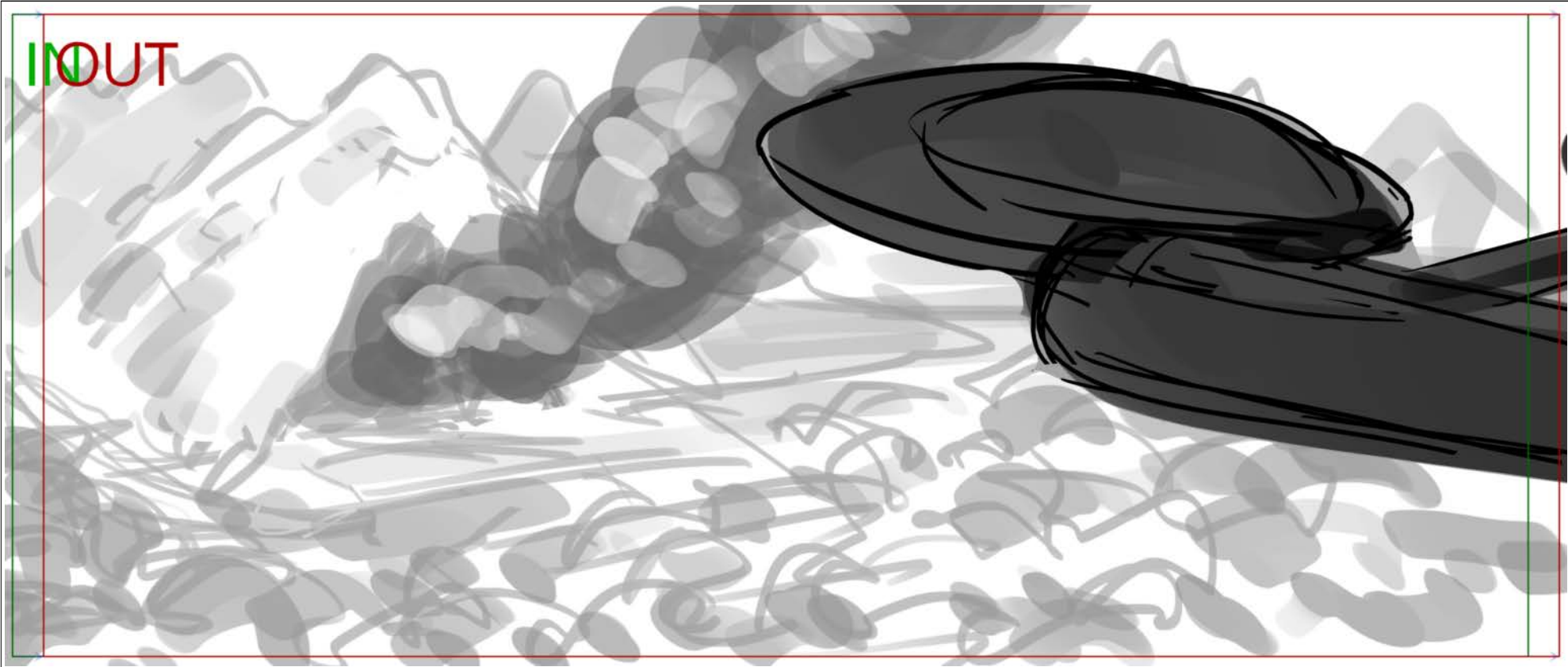

Scene	Duration	Panel	Duration
280	04:00	001C	01:00

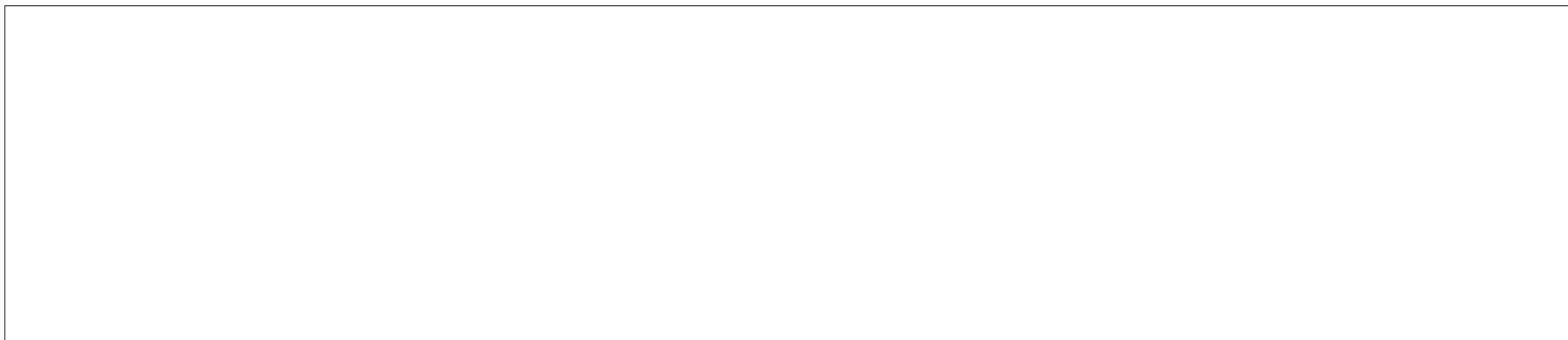
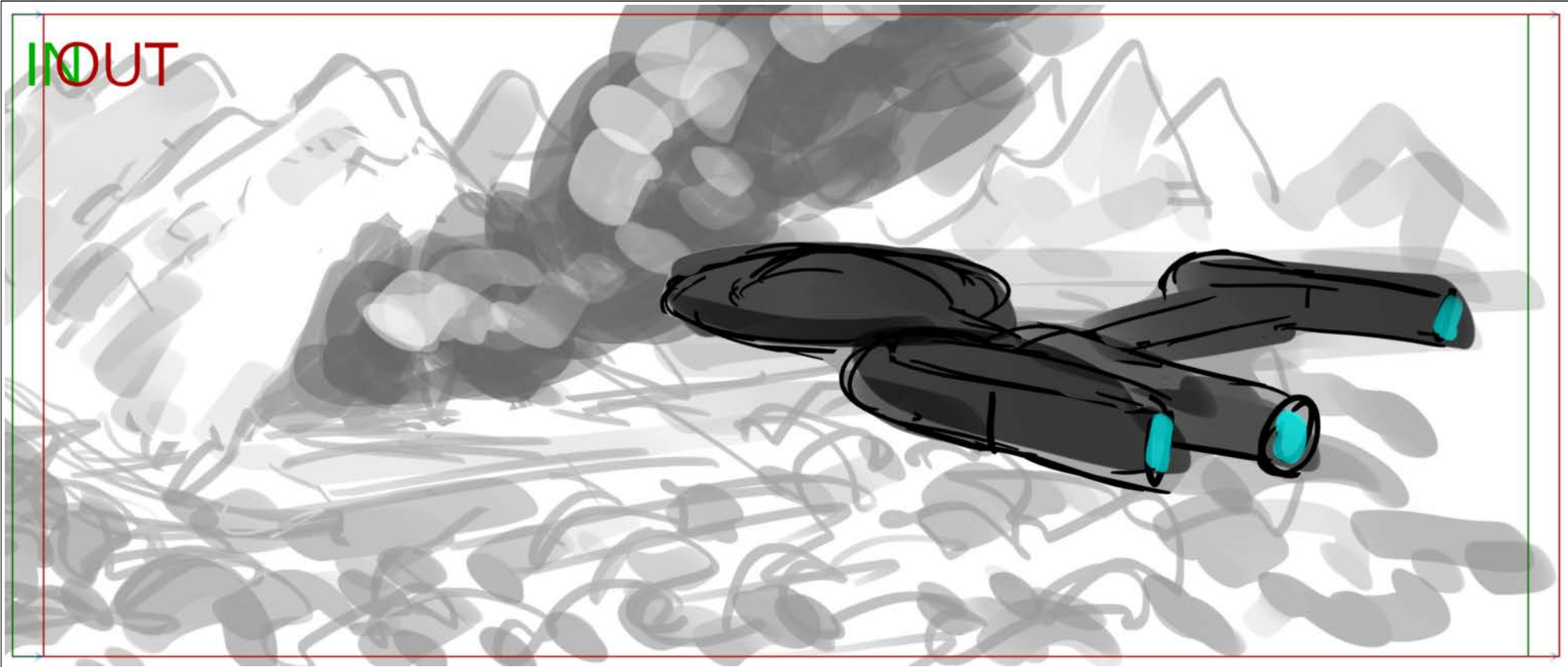

Scene	Duration	Panel	Duration
290	02:00	001	01:00



Dialog

ENSIGN GARROVICK (RECORDING) (CONT'D)

185 ?I tried to do my duty, salvaged what I could from the wreck

Scene	Duration	Panel	Duration
290	02:00	001A	00:13



Scene	Duration	Panel	Duration
290	02:00	02A	00:11

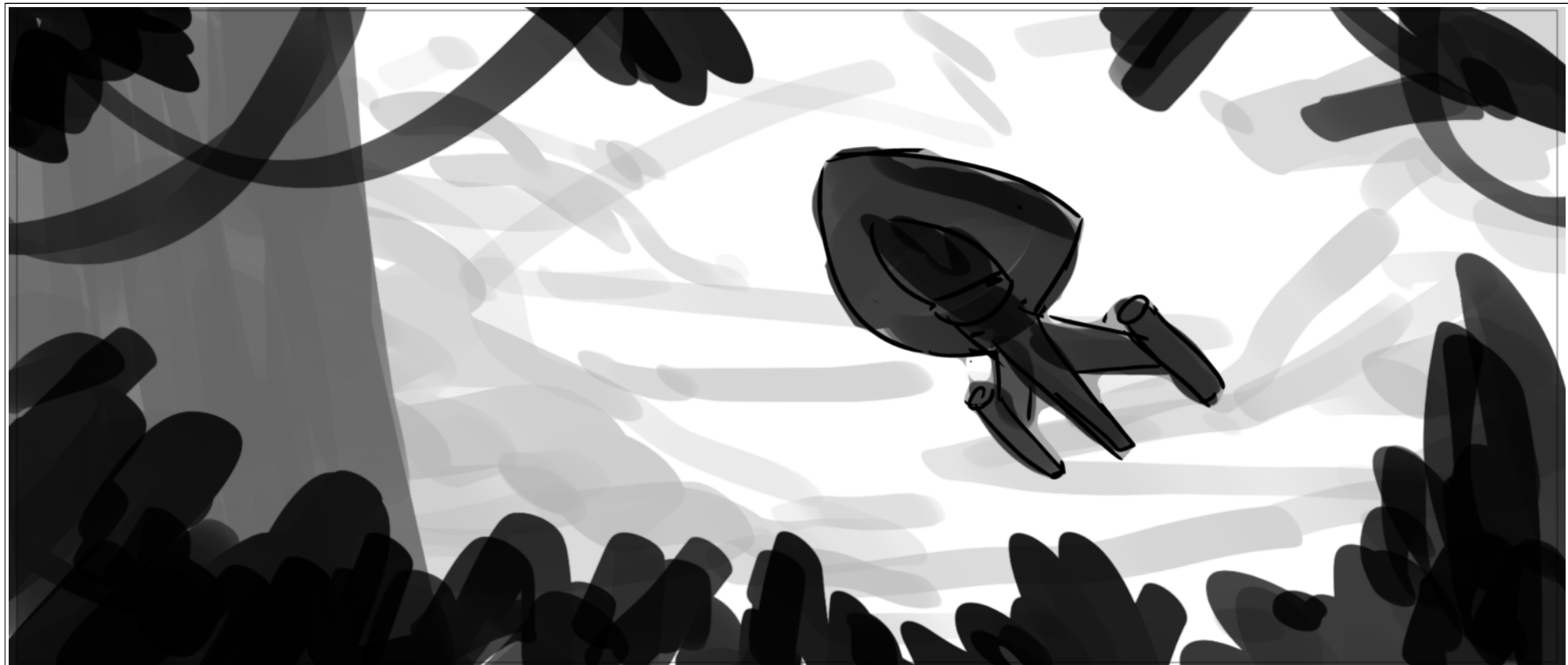

Scene	Duration	Panel	Duration
300	01:23	001	01:00

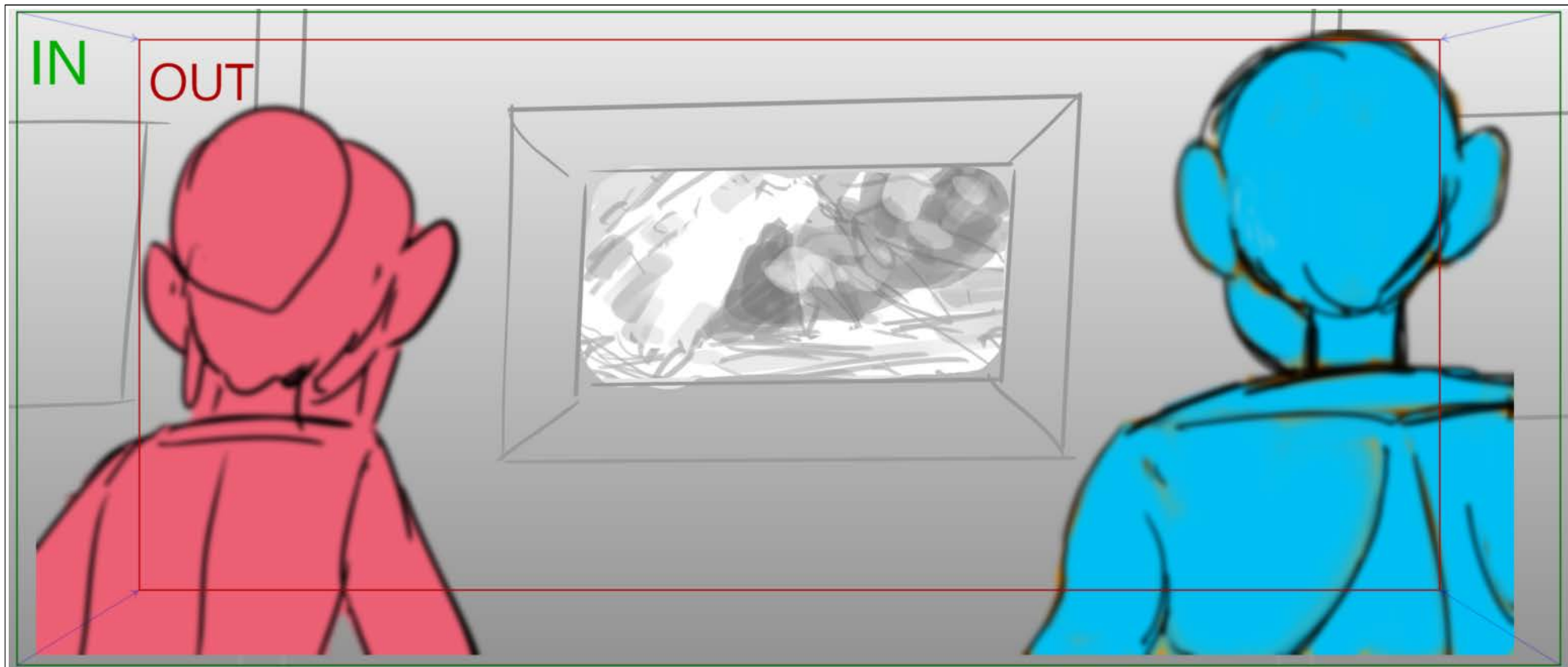

Dialog

went to save the locals from the danger

Scene	Duration	Panel	Duration
300	01:23	001A	00:23

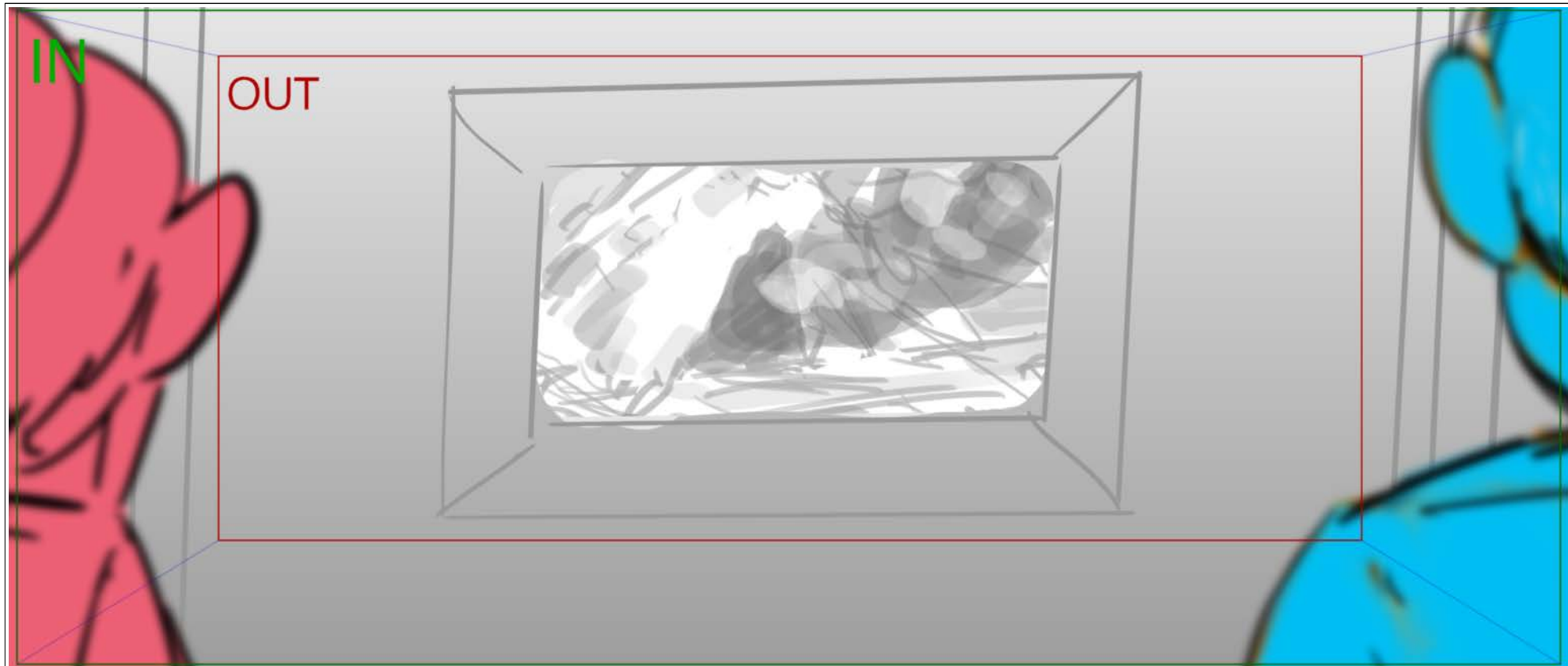

Dialog

went to save the locals from the danger before I fell to my injuries.

Scene	Duration	Panel	Duration
310	01:00	001	01:00

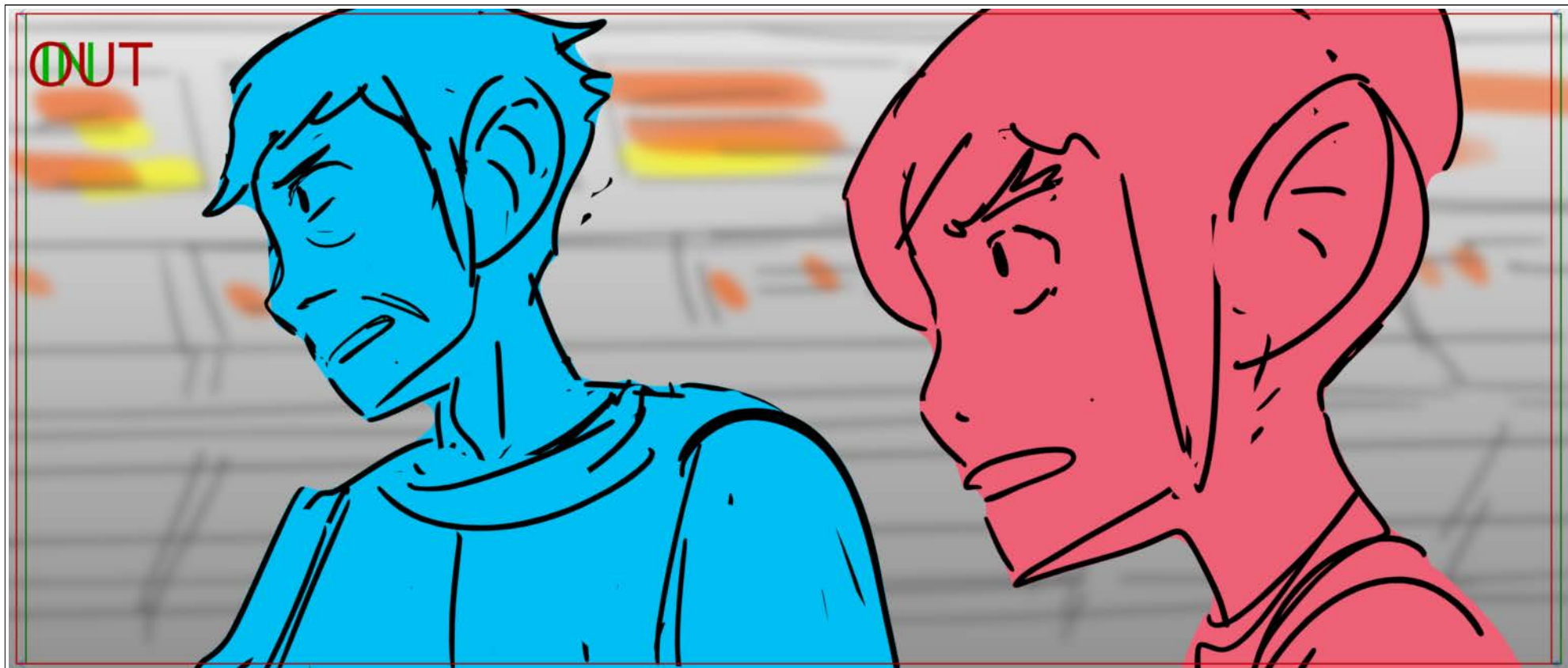

Dialog

But then they welcomed me. Healed me. Gave me hope when I had none.?

Scene	Duration	Panel	Duration
320	01:03	001	00:05

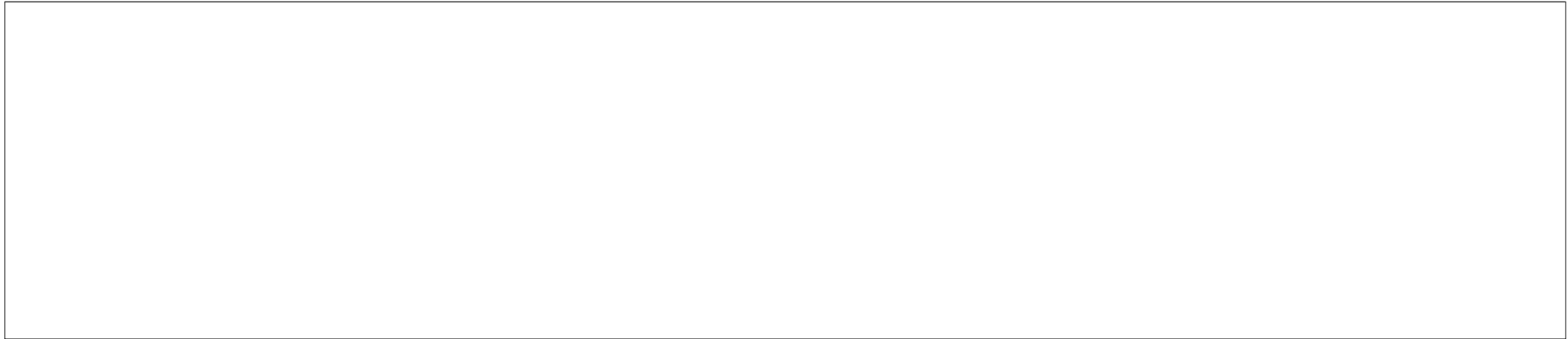

Scene	Duration	Panel	Duration
320	01:03	002	00:02

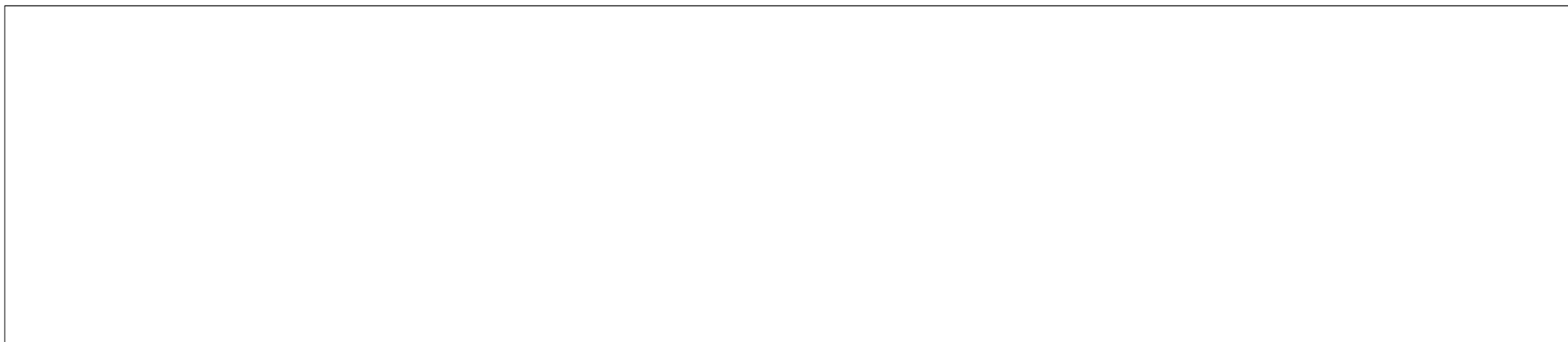

Scene	Duration	Panel	Duration
320	01:03	002A0	00:01

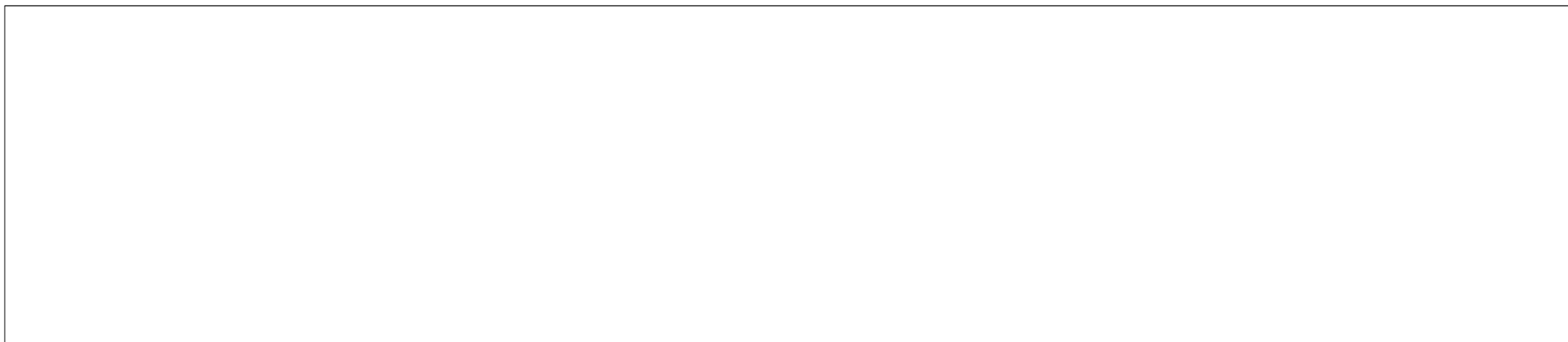
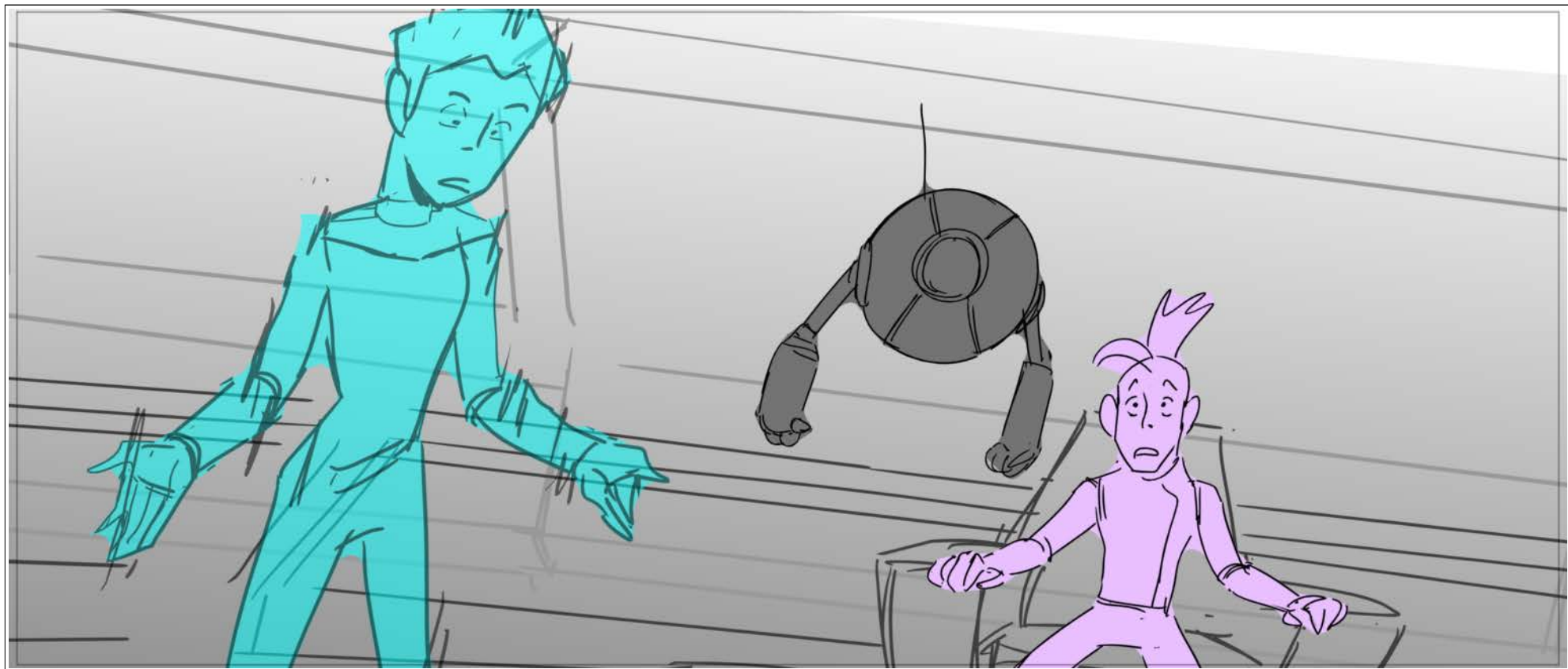

Scene	Duration	Panel	Duration
320	01:03	001A	00:02

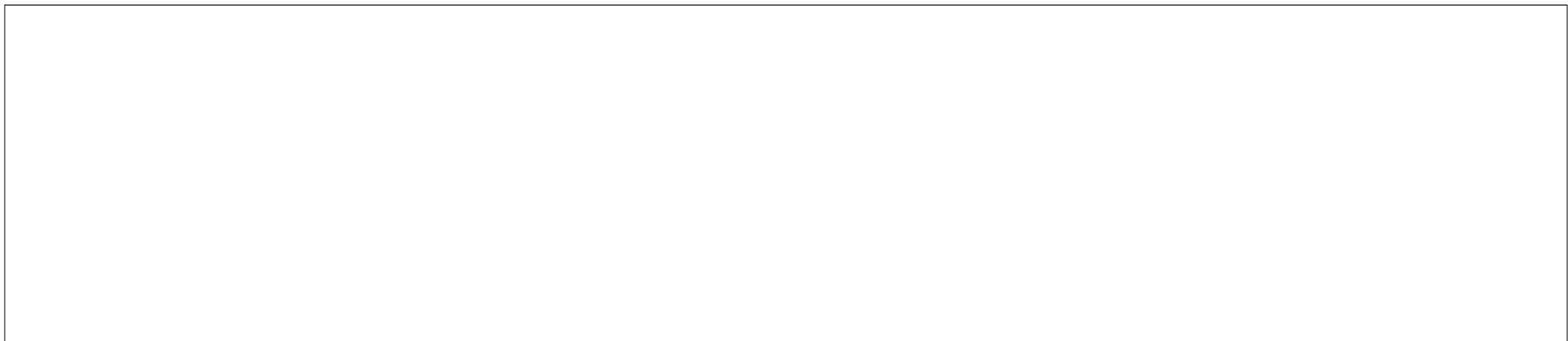

Scene	Duration	Panel	Duration
320	01:03	001C	00:02

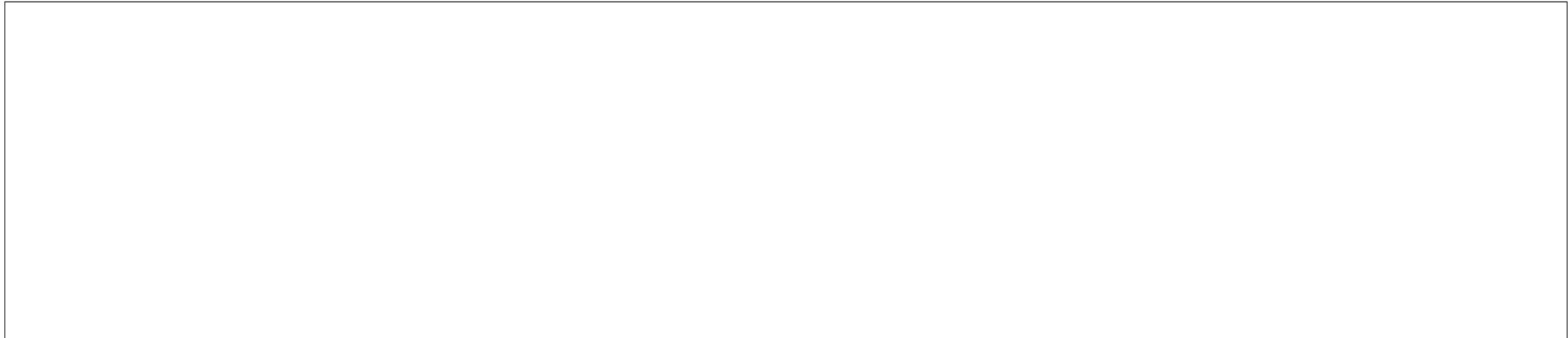

Scene	Duration	Panel	Duration
320	01:03	001B	00:03

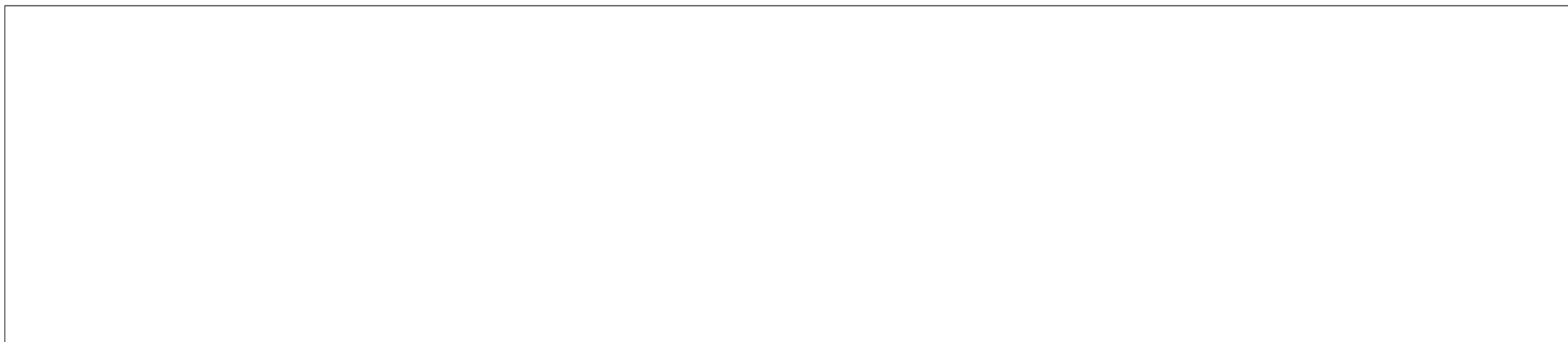

Scene	Duration	Panel	Duration
320	01:03	002A1	00:01

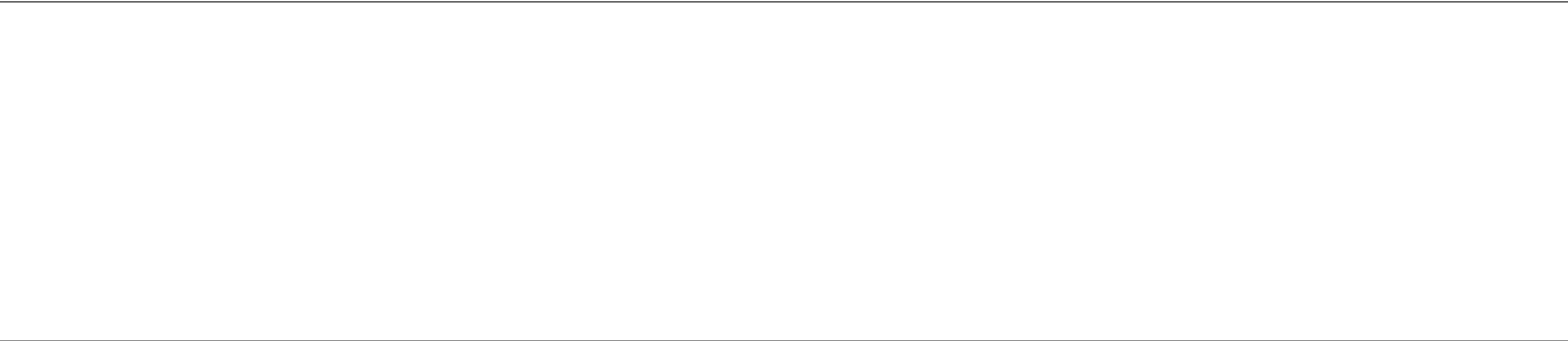
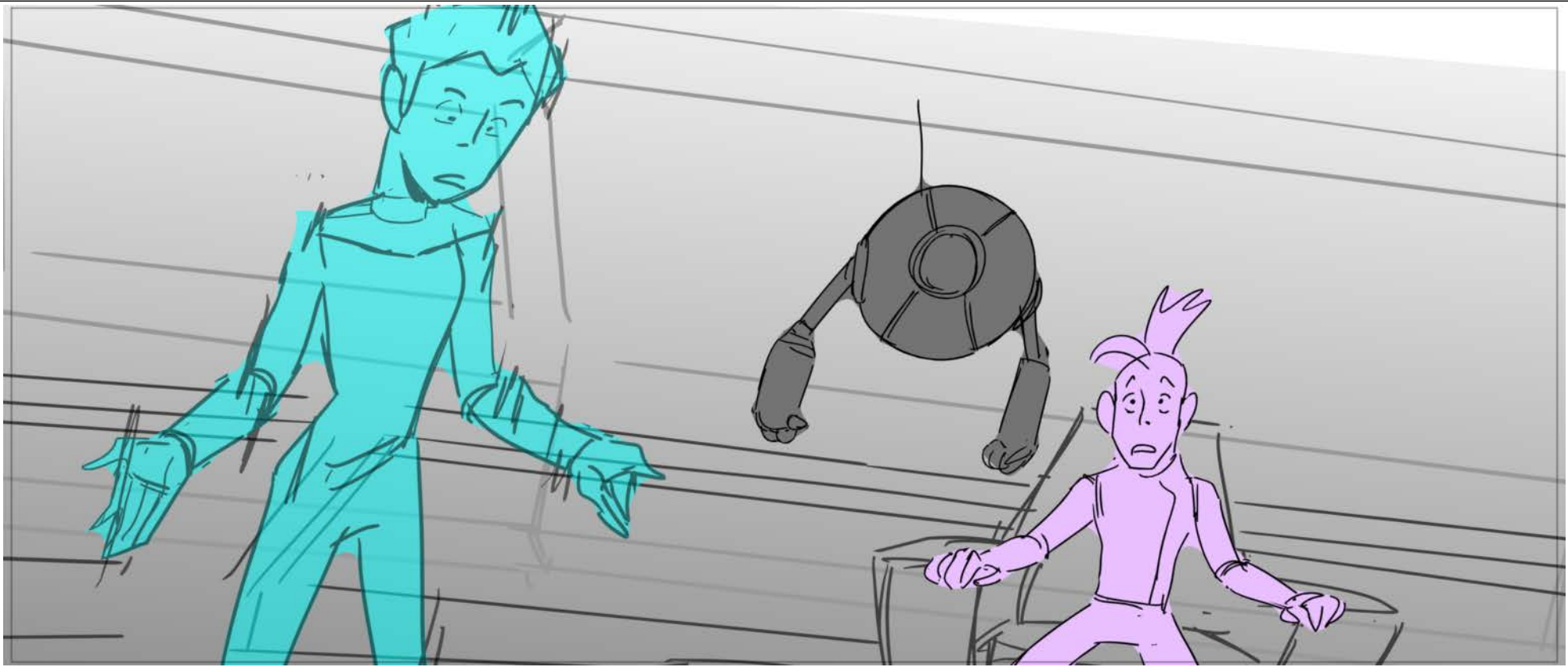

Scene	Duration	Panel	Duration
320	01:03	001D	00:02

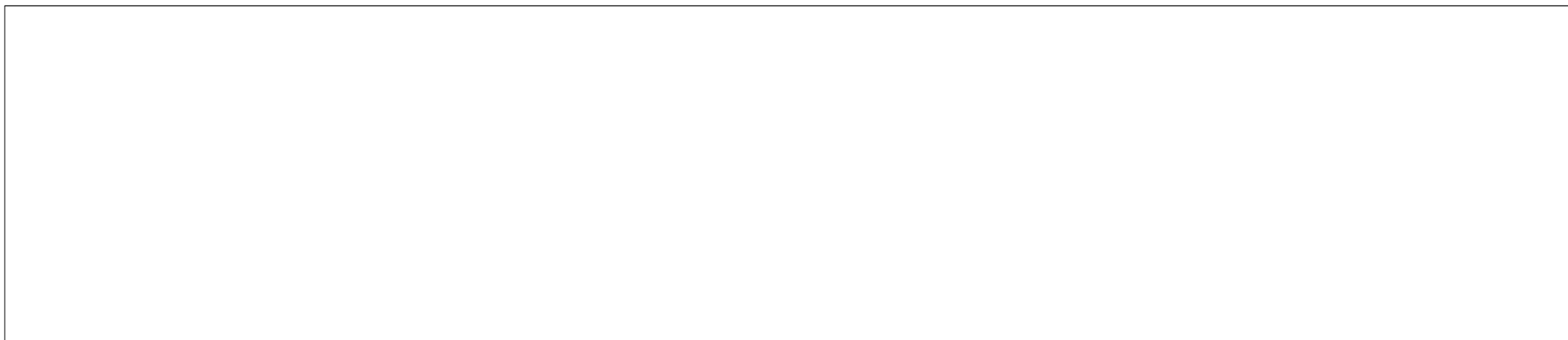

Scene	Duration	Panel	Duration
320	01:03	001E	00:02

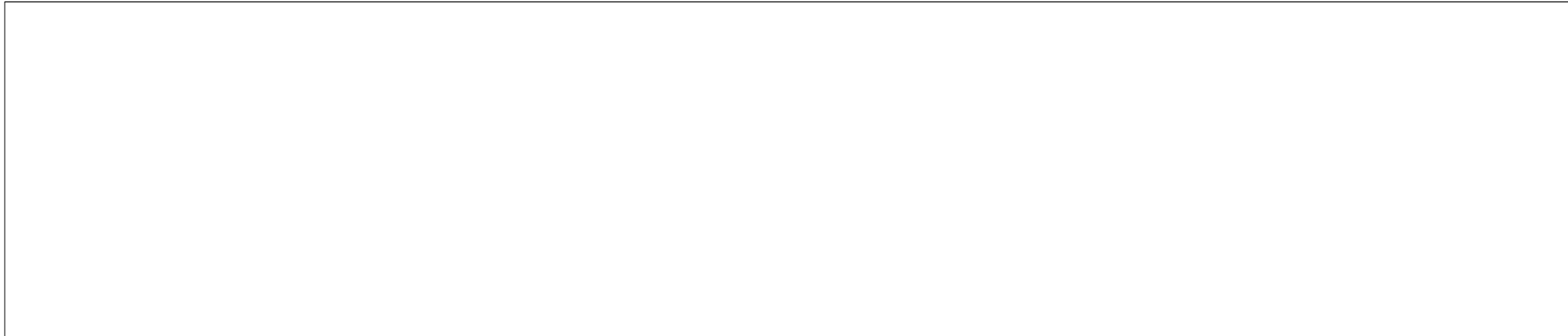

Scene	Duration	Panel	Duration
320	01:03	002A2	00:01

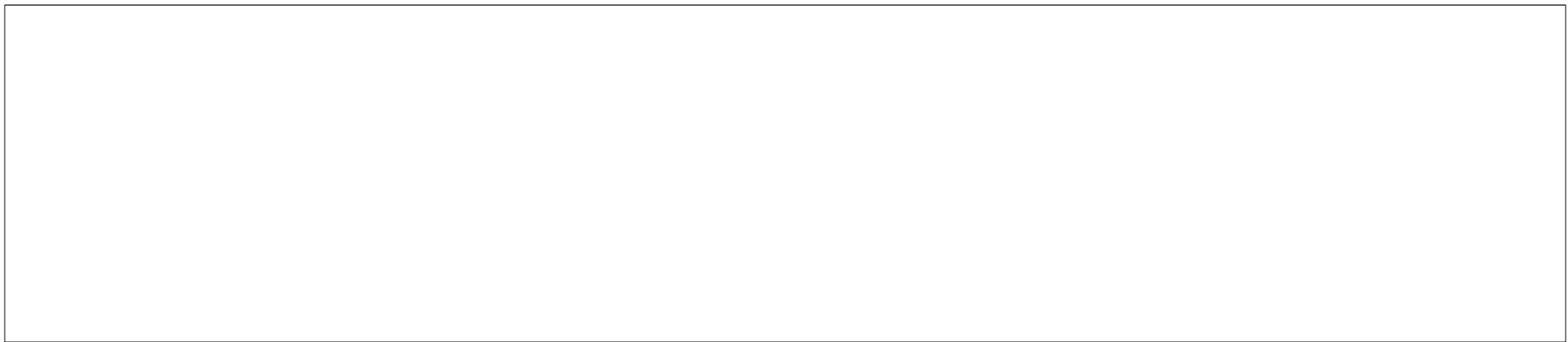

Scene	Duration	Panel	Duration
320	01:03	002A	00:01

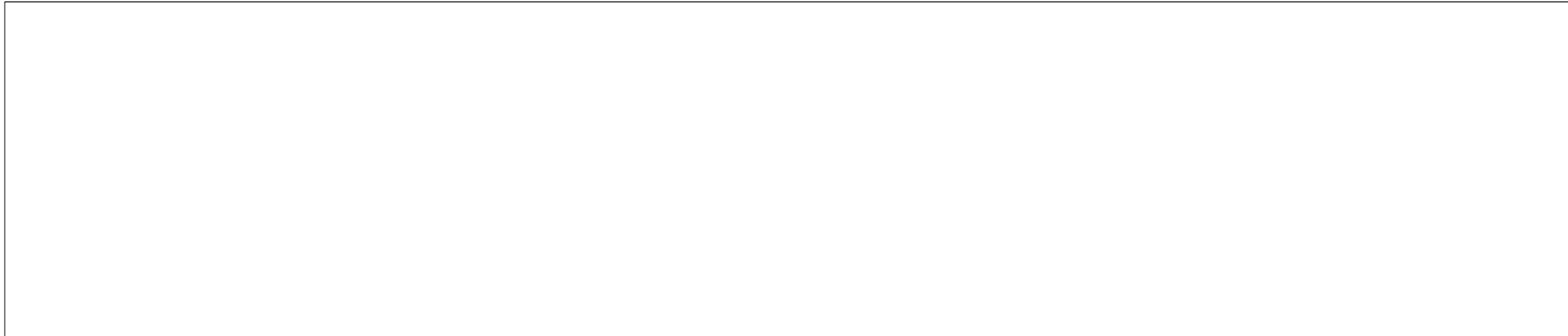

Scene	Duration	Panel	Duration
320	01:03	001A999	00:05

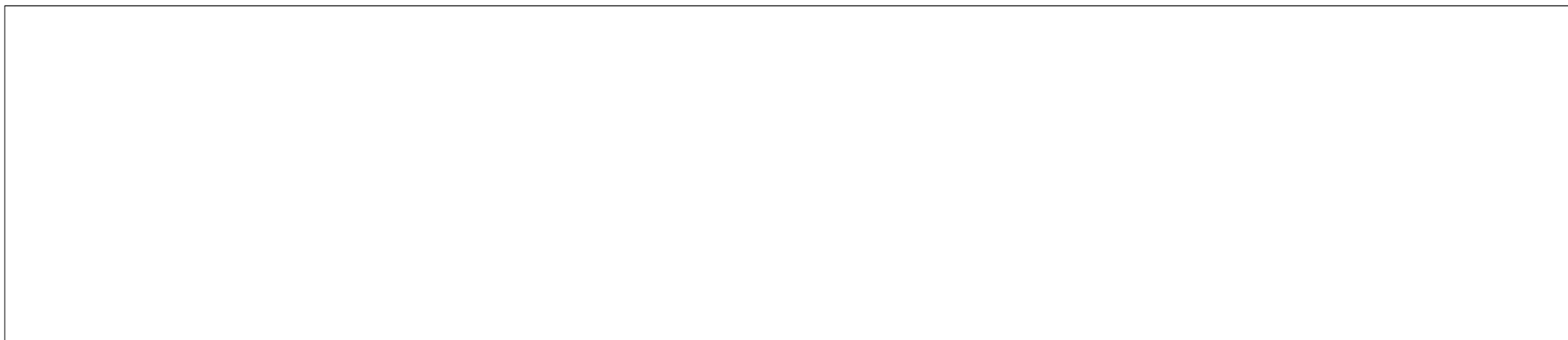

Scene	Duration	Panel	Duration
325	02:09	001	00:02

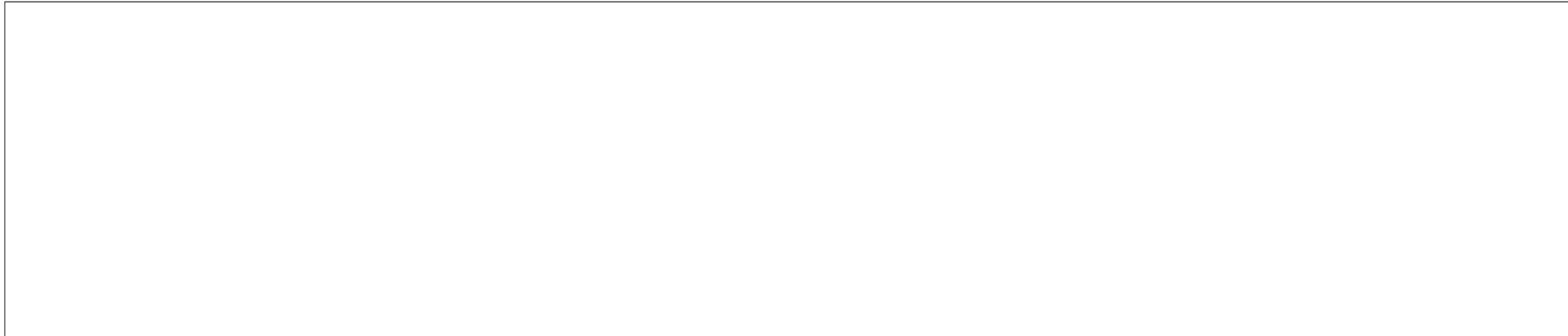

Scene	Duration	Panel	Duration
325	02:09	002	00:03

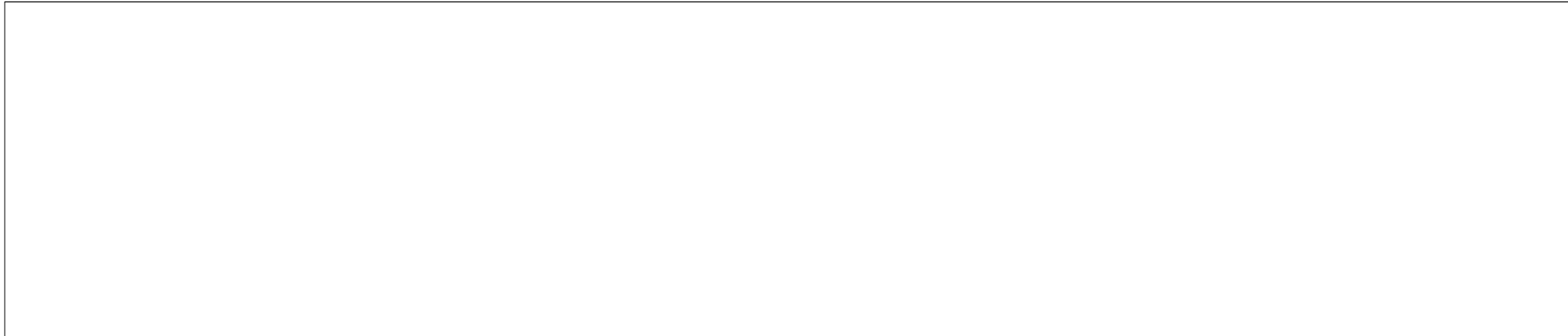

Scene	Duration	Panel	Duration
325	02:09	003	00:03

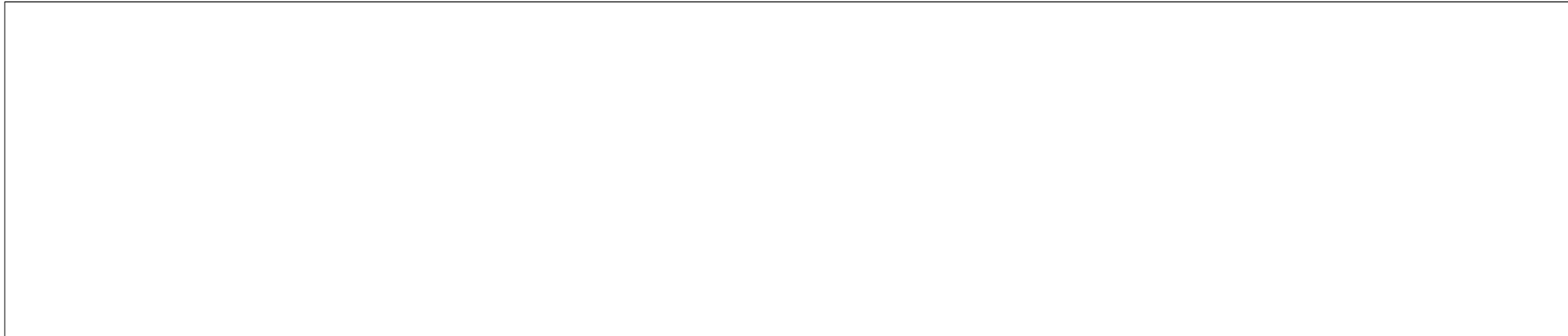
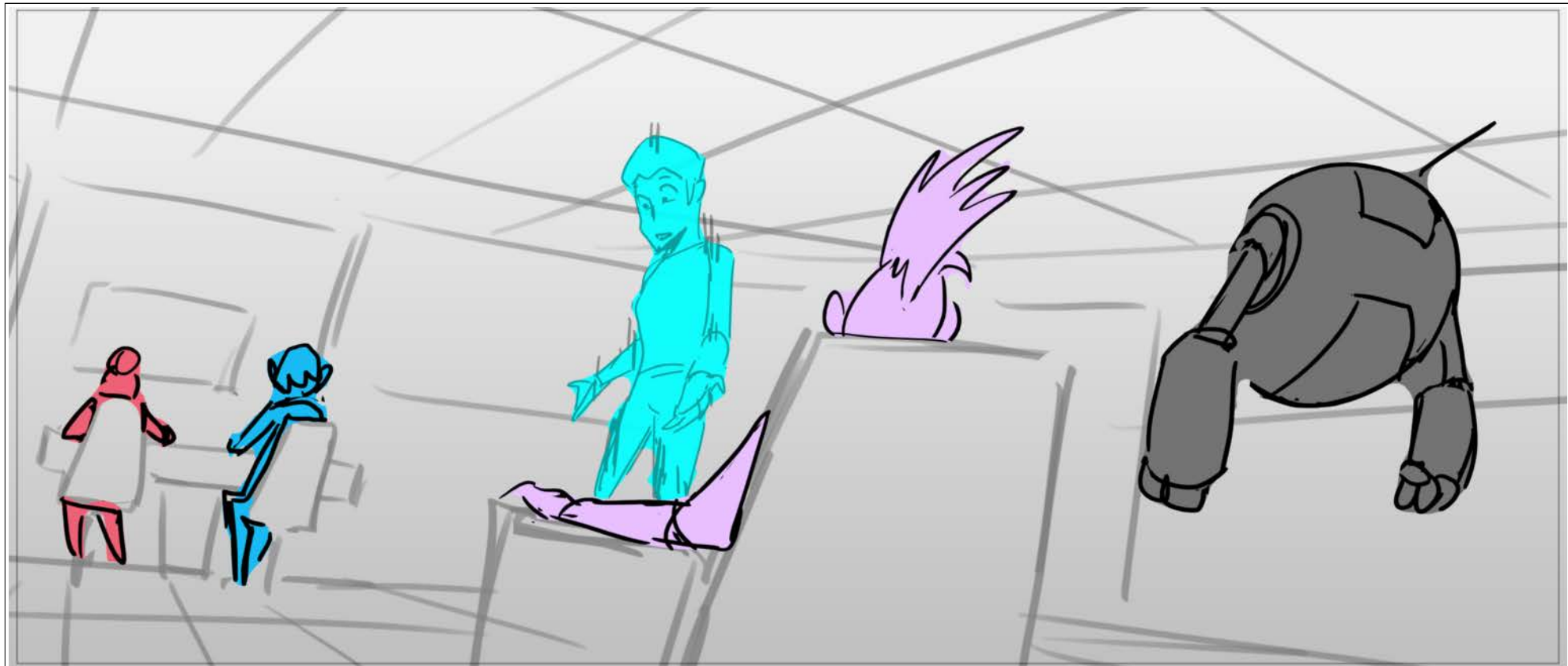

Scene	Duration	Panel	Duration
325	02:09	004	00:01

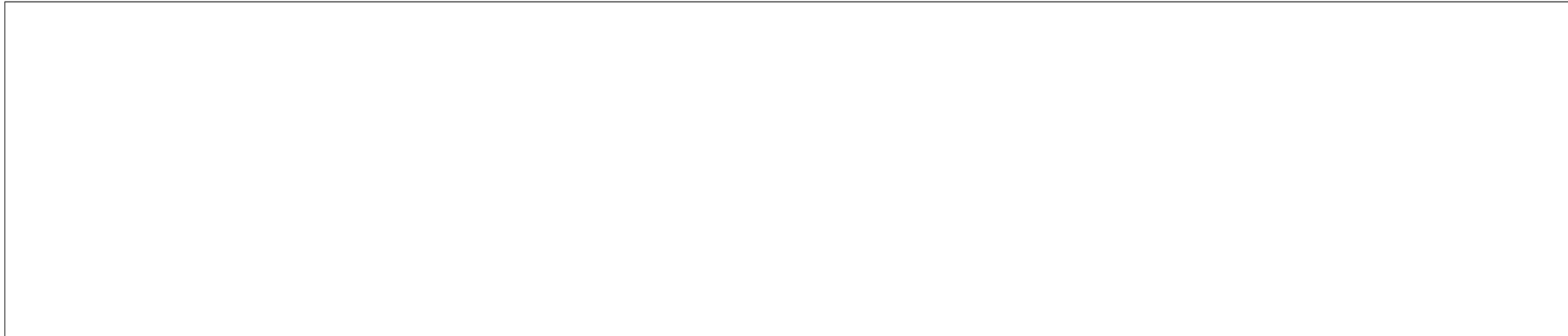

Scene	Duration	Panel	Duration
325	02:09	001A	00:03

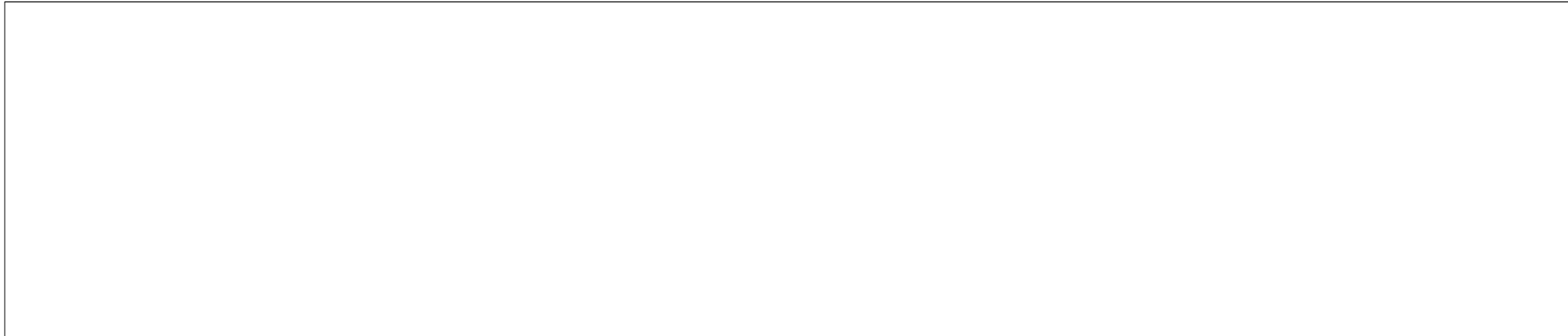

Scene	Duration	Panel	Duration
325	02:09	001B	00:03

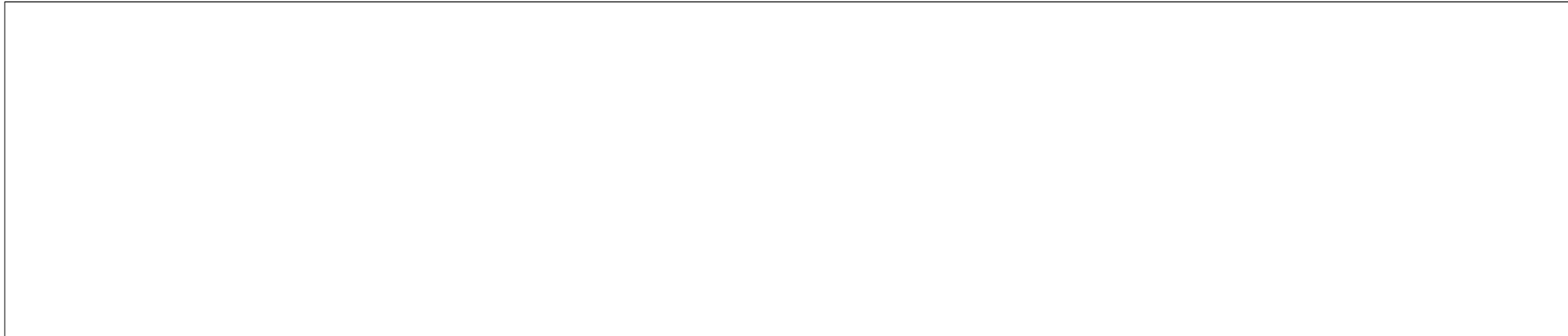

Scene	Duration	Panel	Duration
325	02:09	001C	00:03

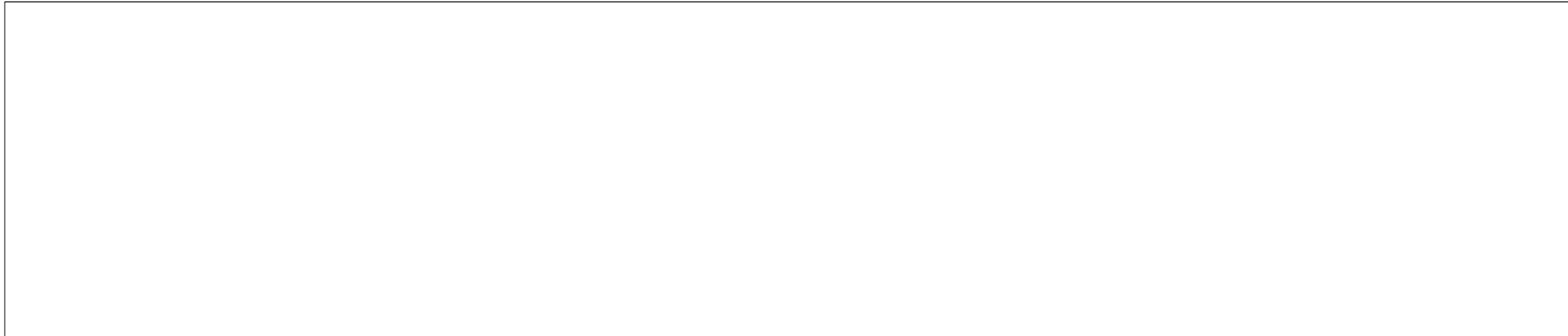

Scene	Duration	Panel	Duration
325	02:09	001D	00:03

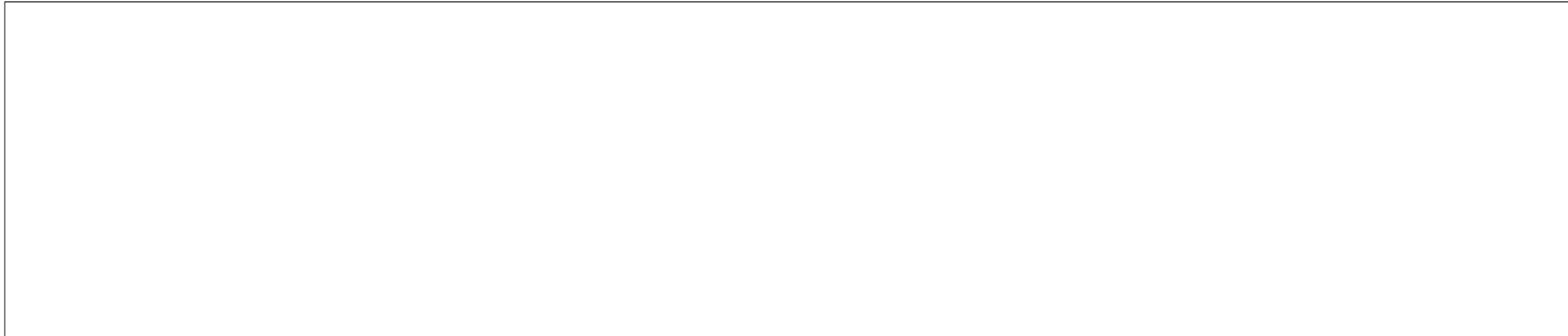

Scene	Duration	Panel	Duration
325	02:09	002A	00:03

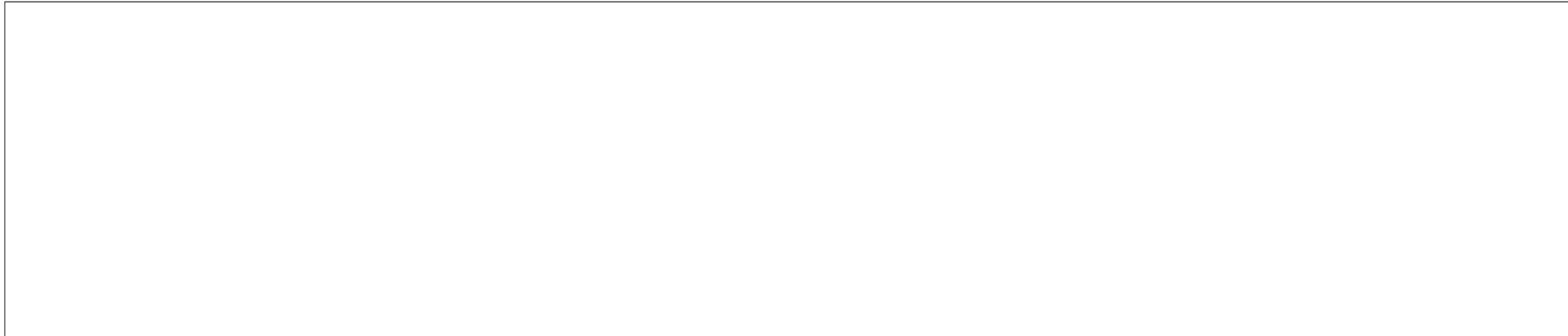

Scene	Duration	Panel	Duration
325	02:09	002A0	00:03

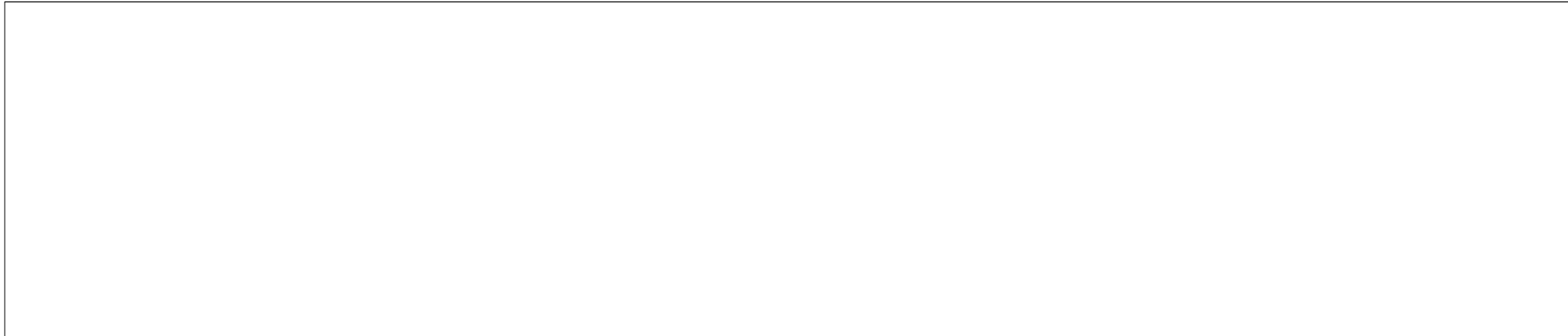

Scene	Duration	Panel	Duration
325	02:09	003A	00:03

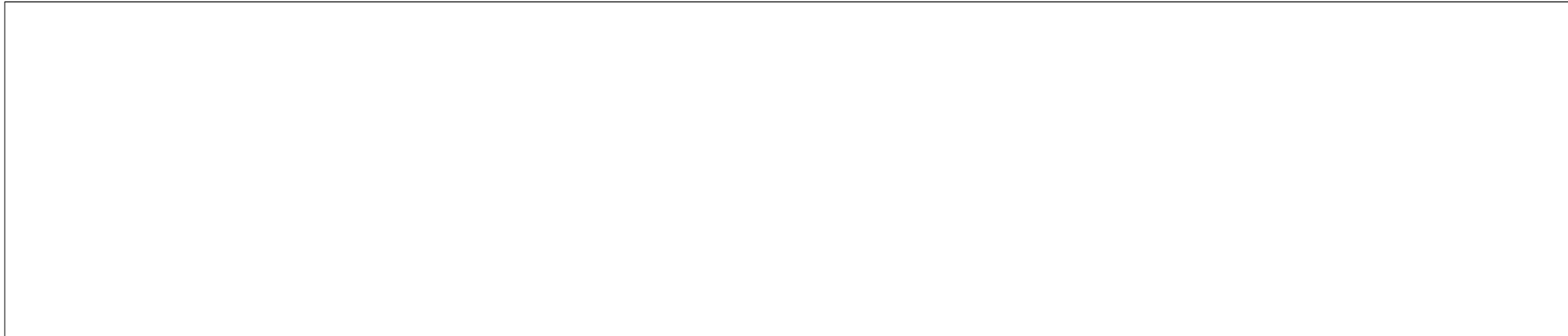
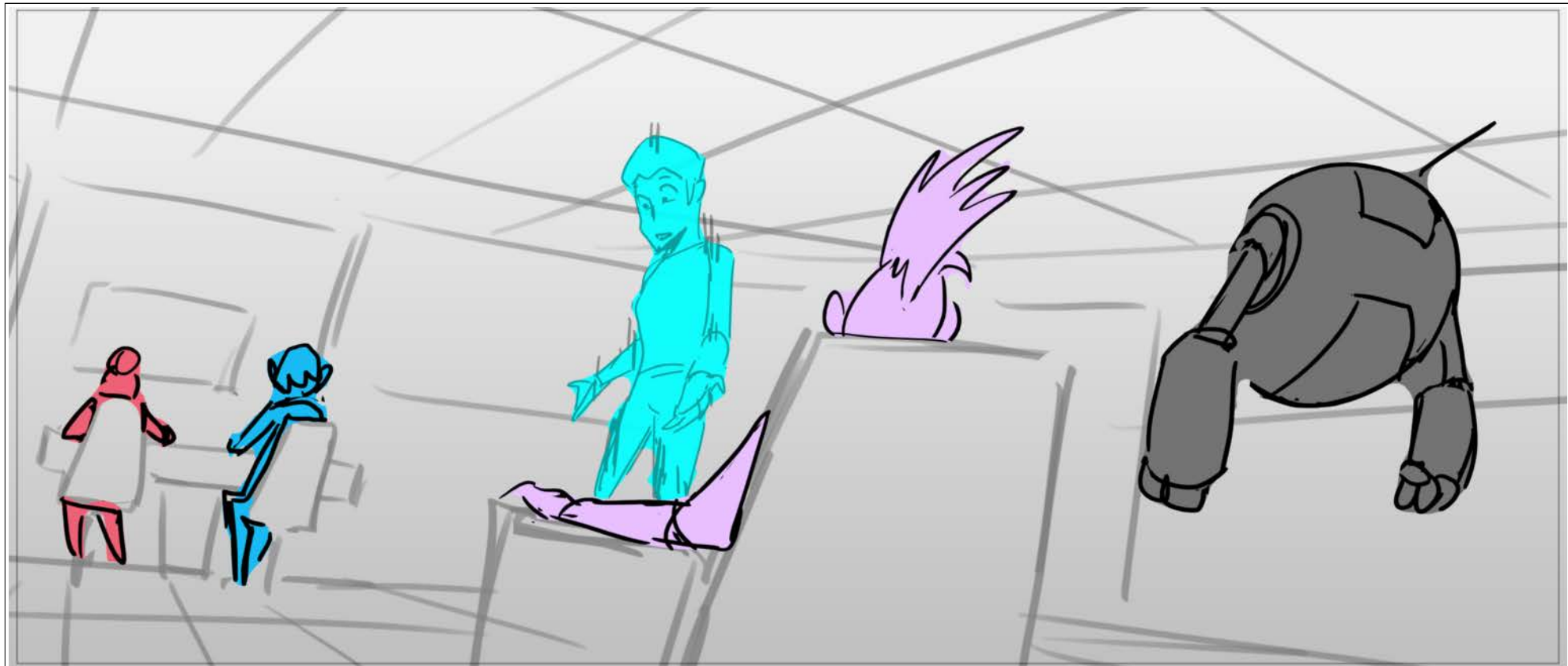

Scene	Duration	Panel	Duration
325	02:09	004A	00:01

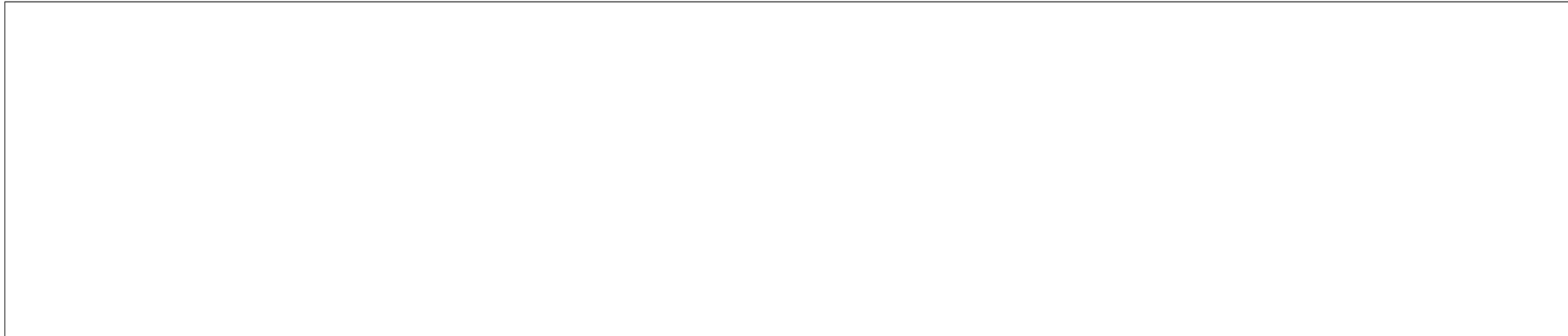

Scene	Duration	Panel	Duration
325	02:09	001E	00:03

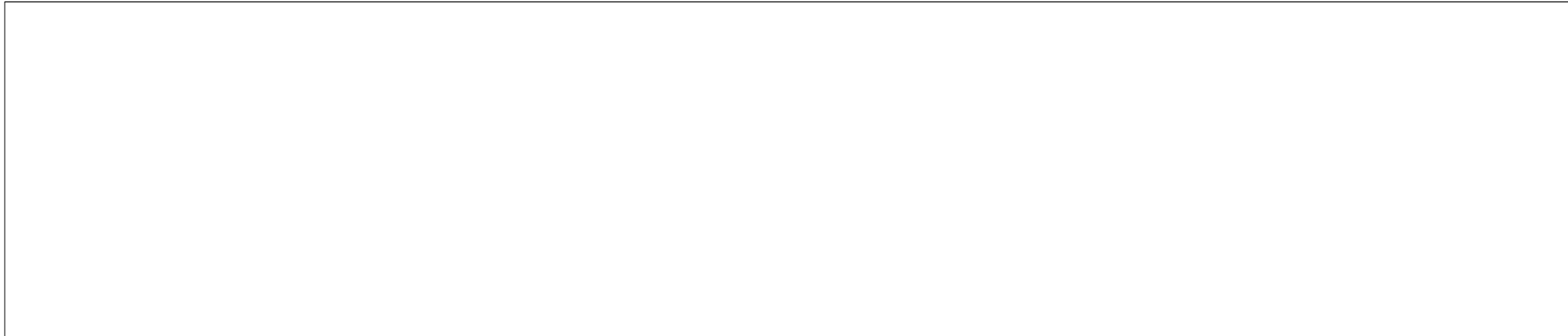

Scene	Duration	Panel	Duration
325	02:09	001F	00:03

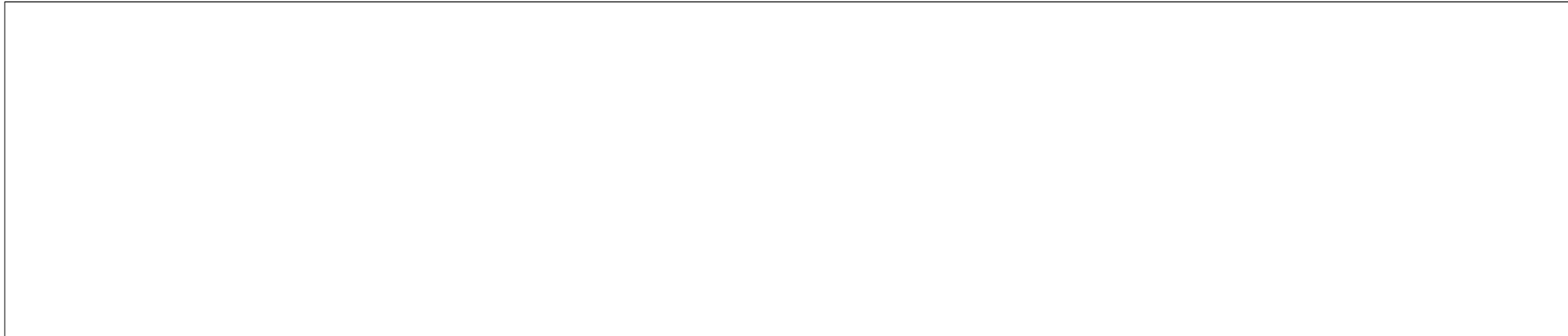

Scene	Duration	Panel	Duration
325	02:09	001G	00:20

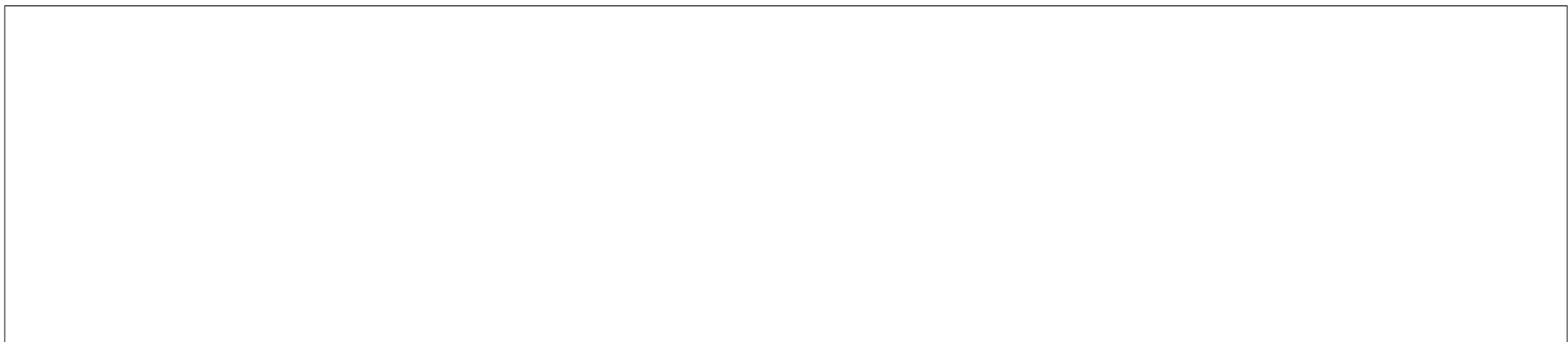

Scene	Duration	Panel	Duration
330	01:06	001	00:15

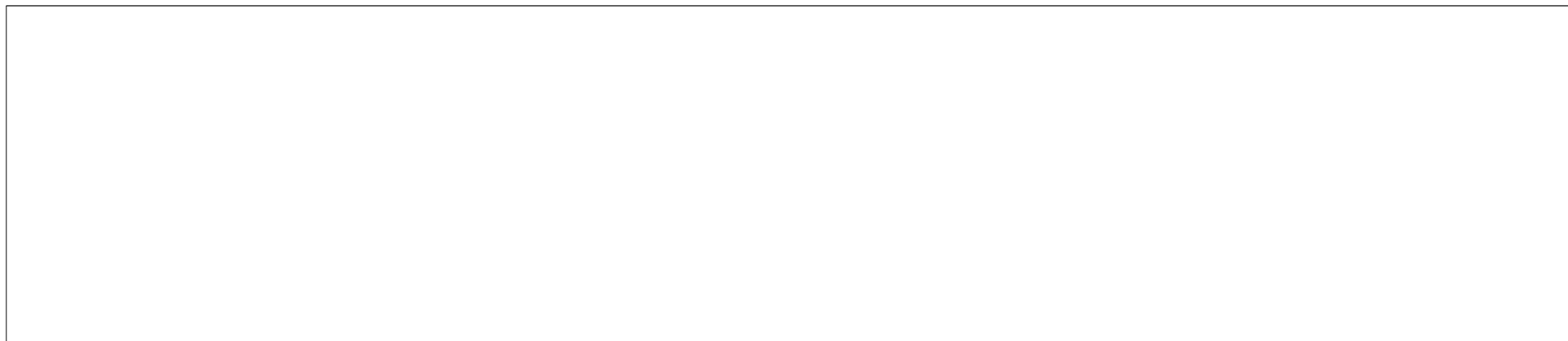

Scene	Duration	Panel	Duration
330	01:06	001A	00:15

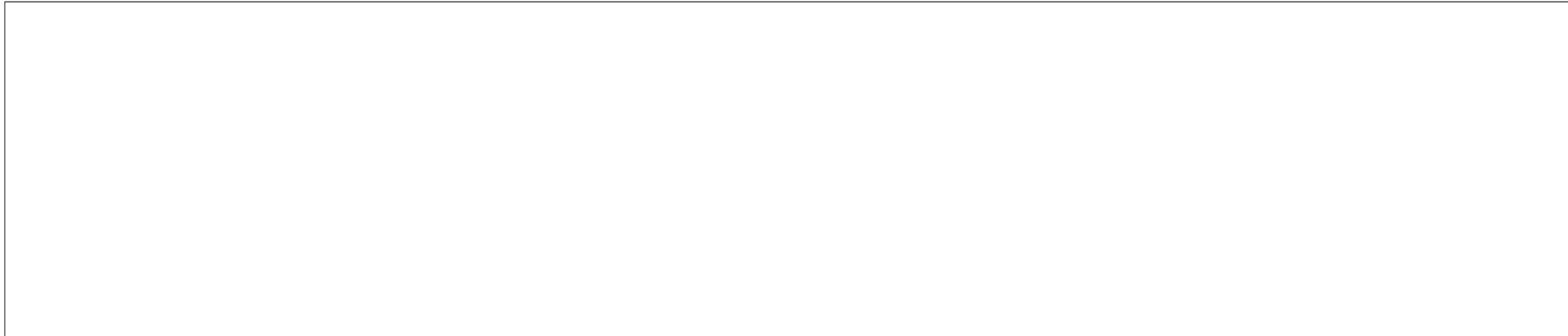

Scene	Duration	Panel	Duration
340	01:18	001	01:18

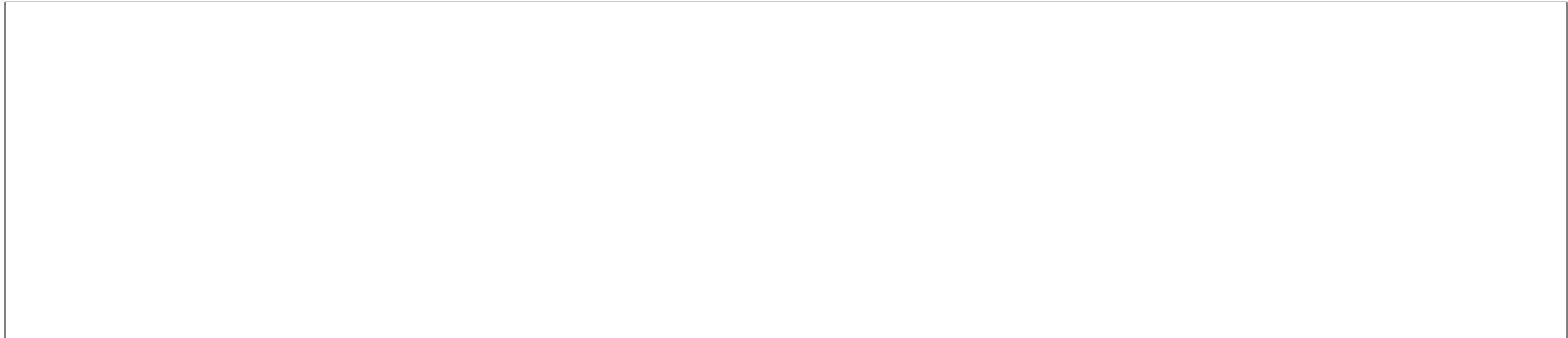

Scene	Duration	Panel	Duration
340	01:18	001	01:18

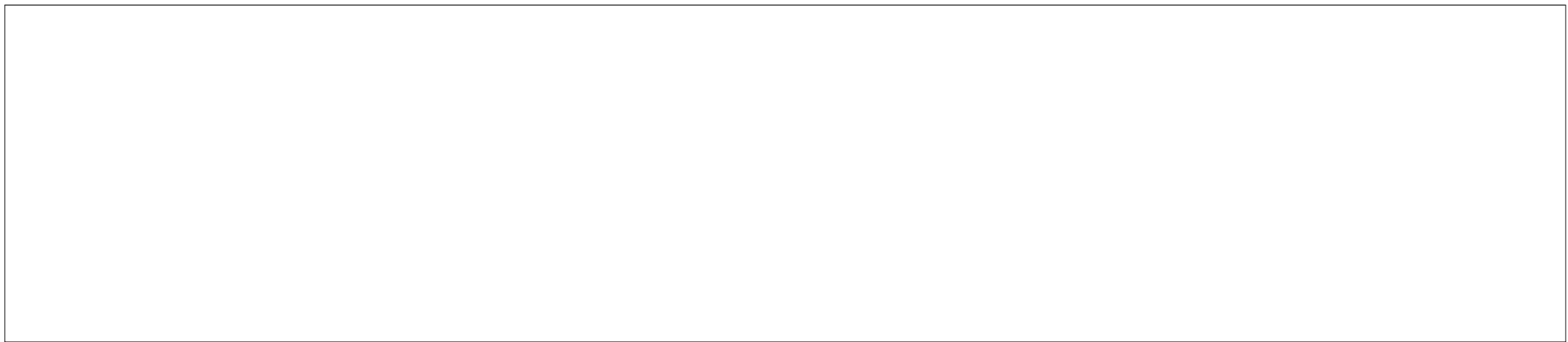

Scene	Duration	Panel	Duration
342	02:01	001	02:01

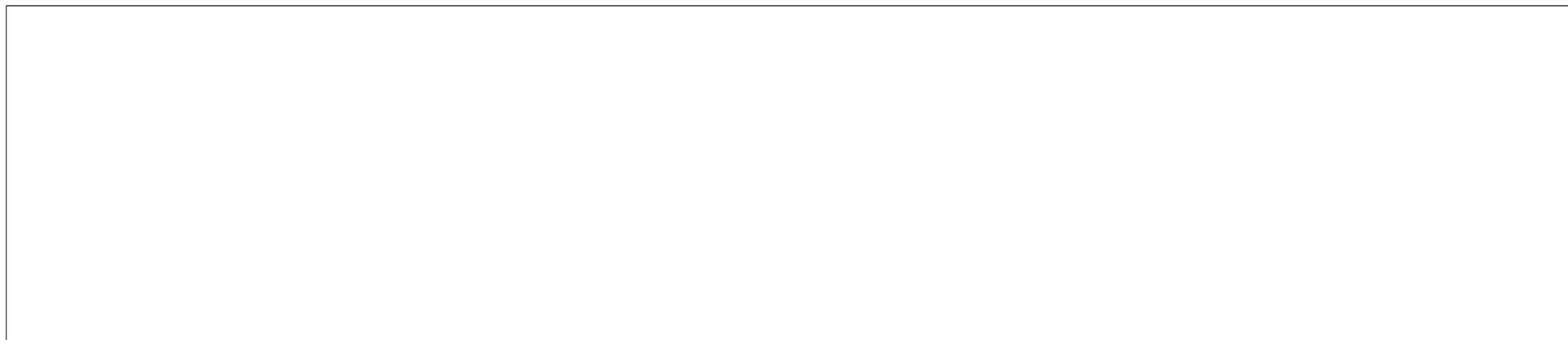

Scene	Duration	Panel	Duration
342	02:01	001	02:01

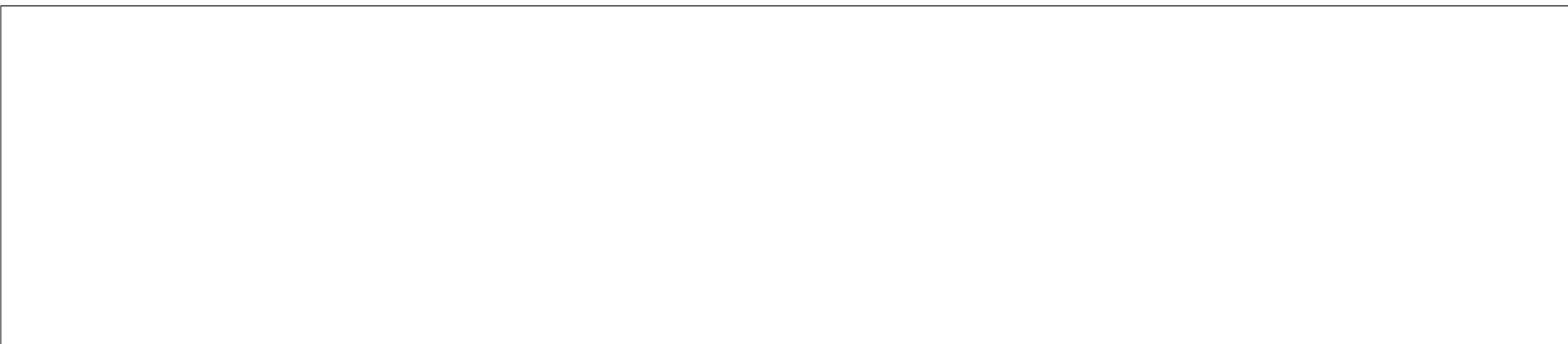

Scene	Duration	Panel	Duration
346	01:04	001	01:04

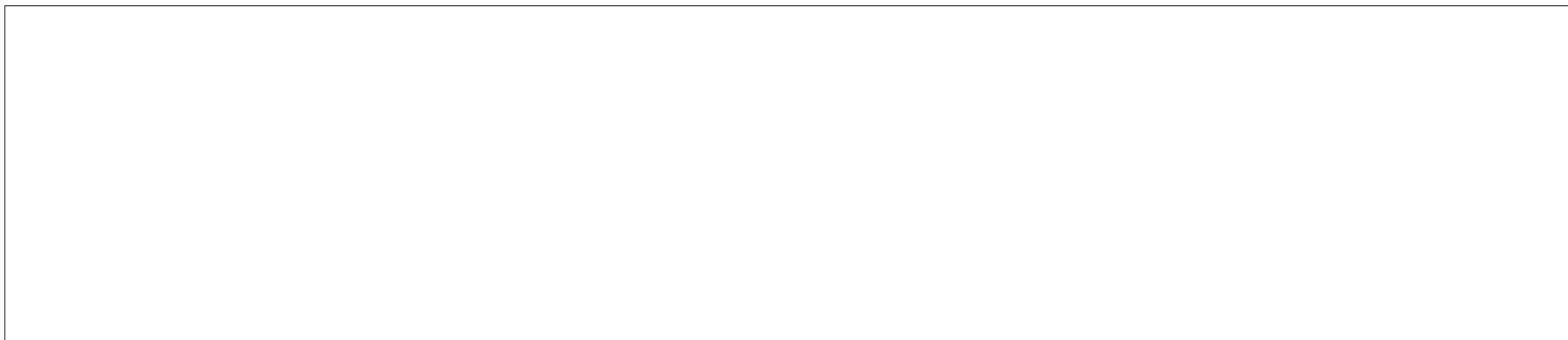

Scene	Duration	Panel	Duration
355	00:20	001F	00:04

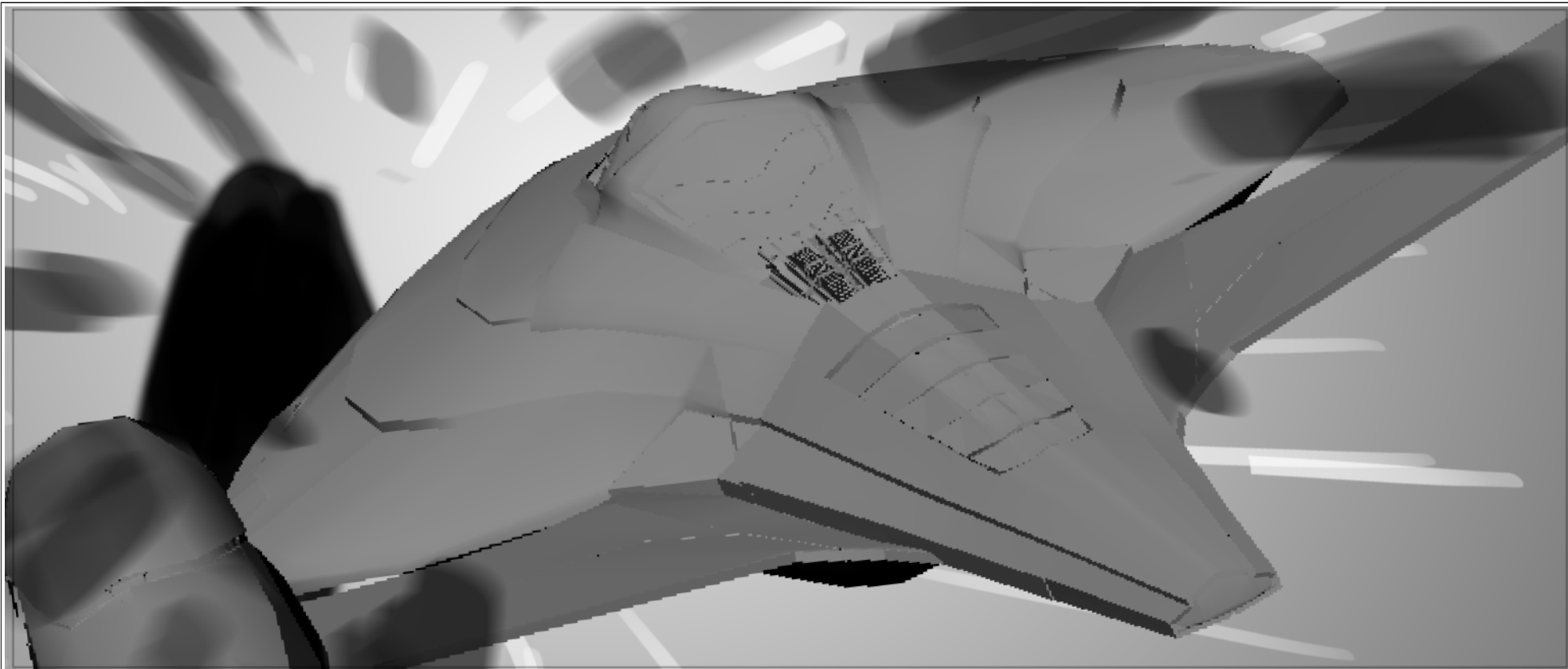

Dialog

ENSIGN GARROVICK (RECORDING) (CONT'D)

186 ?In the end... they were the ones who saved me.?

Scene	Duration	Panel	Duration
355	00:20	02F	00:05

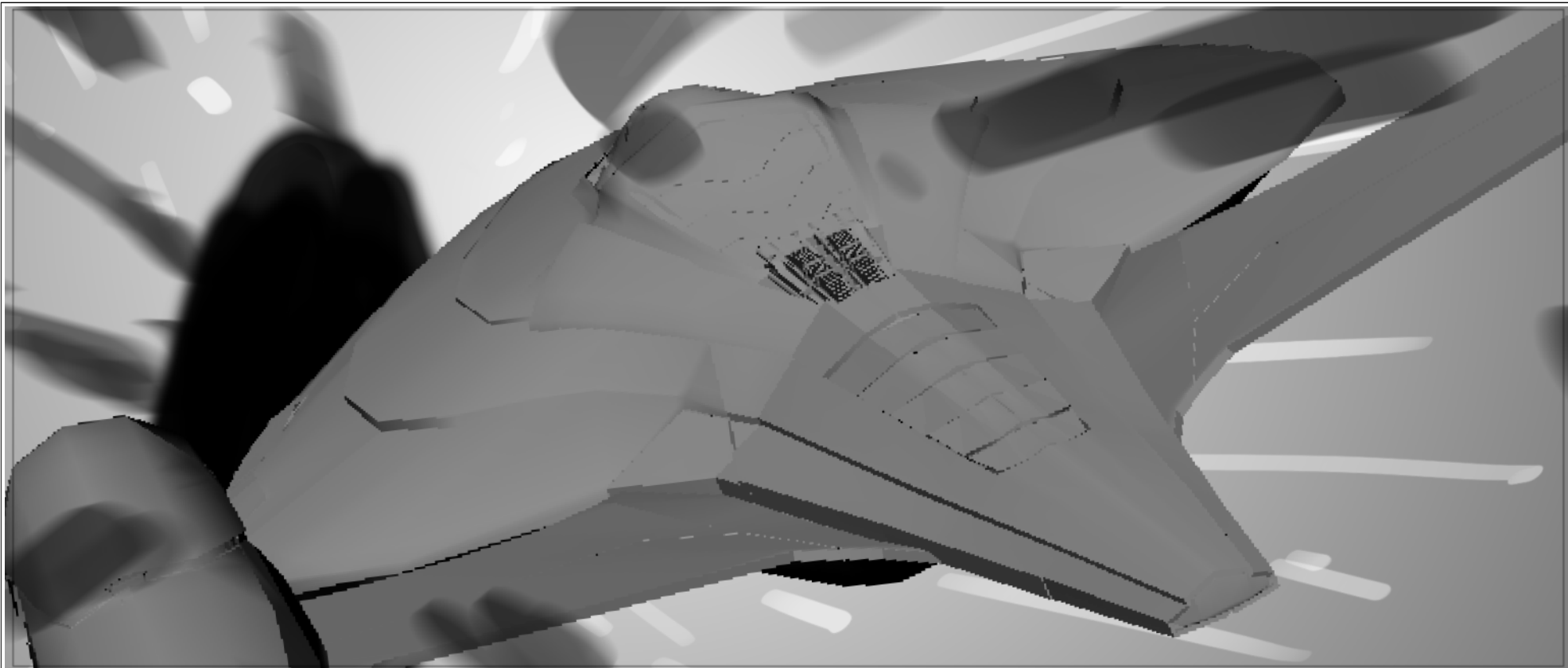

Dialog

ENSIGN GARROVICK (RECORDING) (CONT'D)

186 ?In the end... they were the ones who saved me.?

Scene	Duration	Panel	Duration
355	00:20	03F	00:05

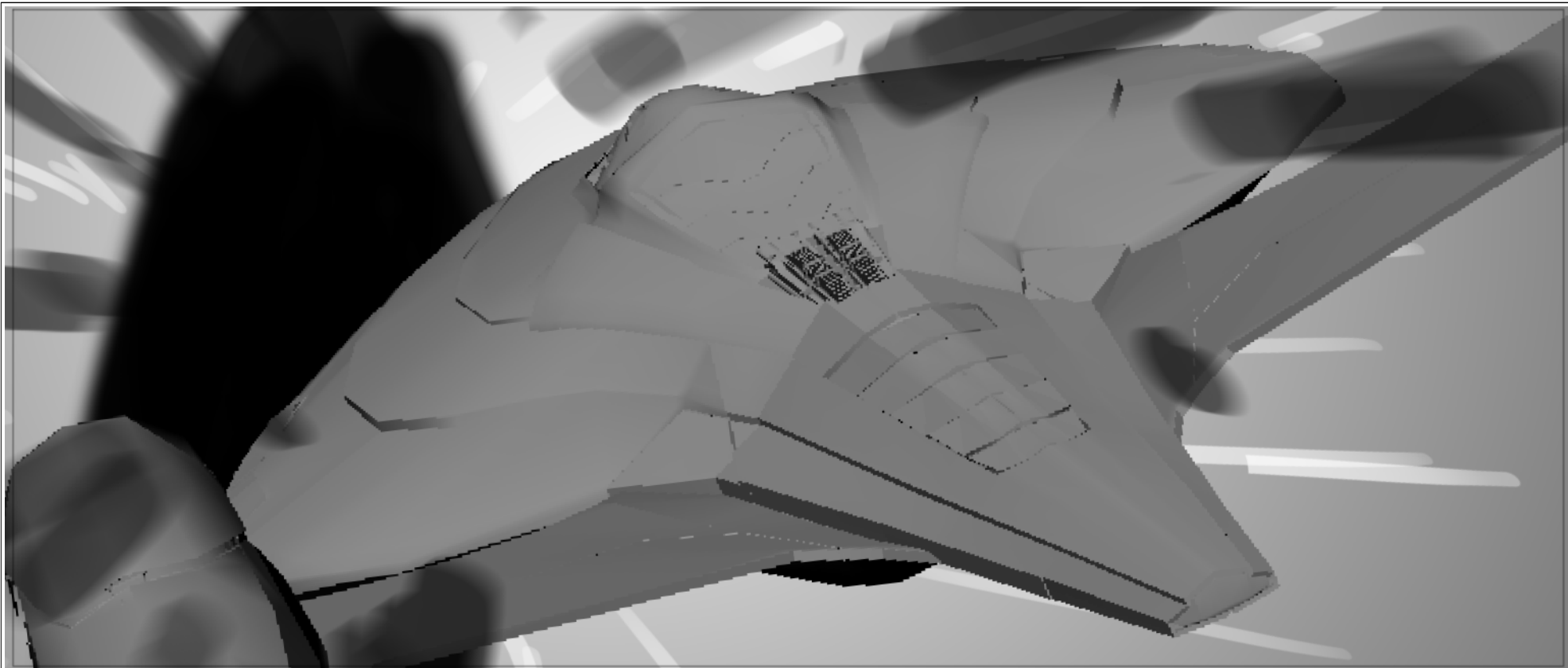

Dialog

ENSIGN GARROVICK (RECORDING) (CONT'D)

186 ?In the end... they were the ones who saved me.?

Scene	Duration	Panel	Duration
355	00:20	04F	00:06

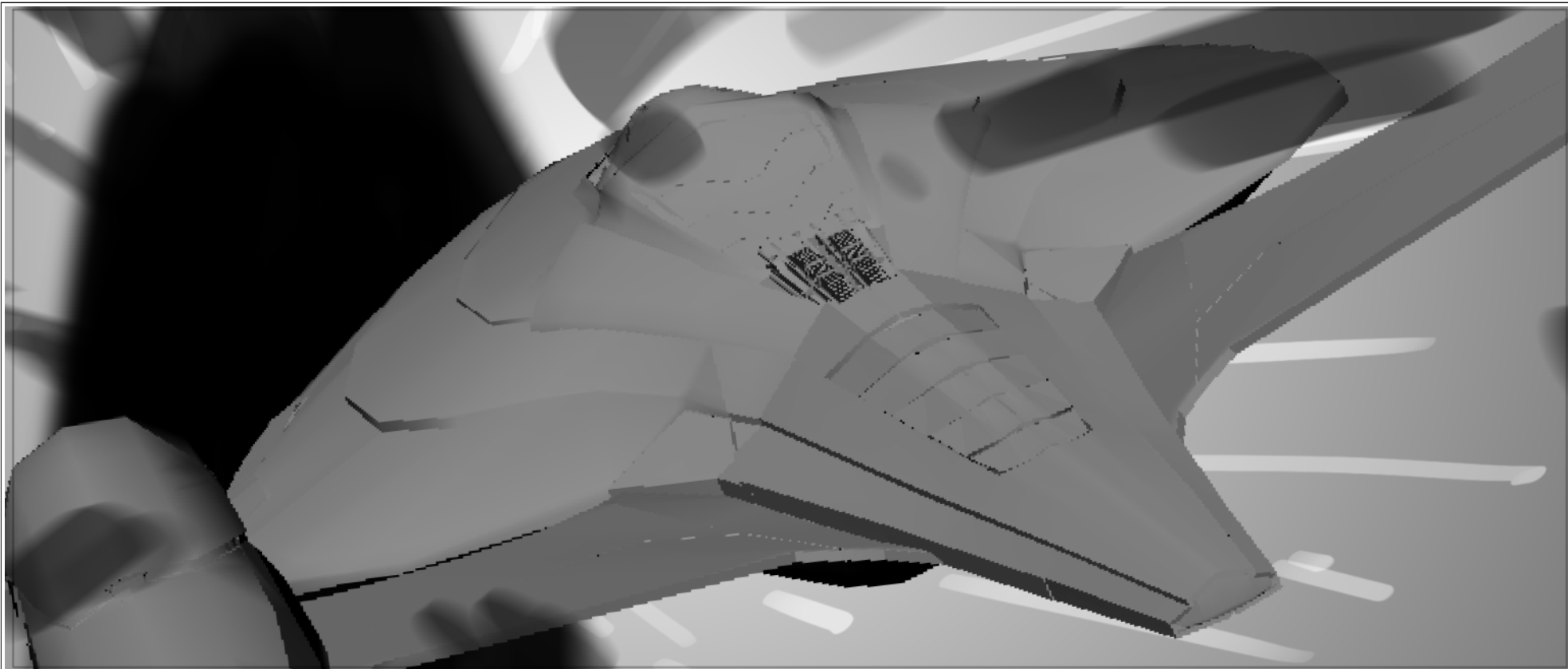

Dialog

ENSIGN GARROVICK (RECORDING) (CONT'D)

186 ?In the end... they were the ones who saved me.?

Scene	Duration	Panel	Duration
350	02:13	001L	00:04

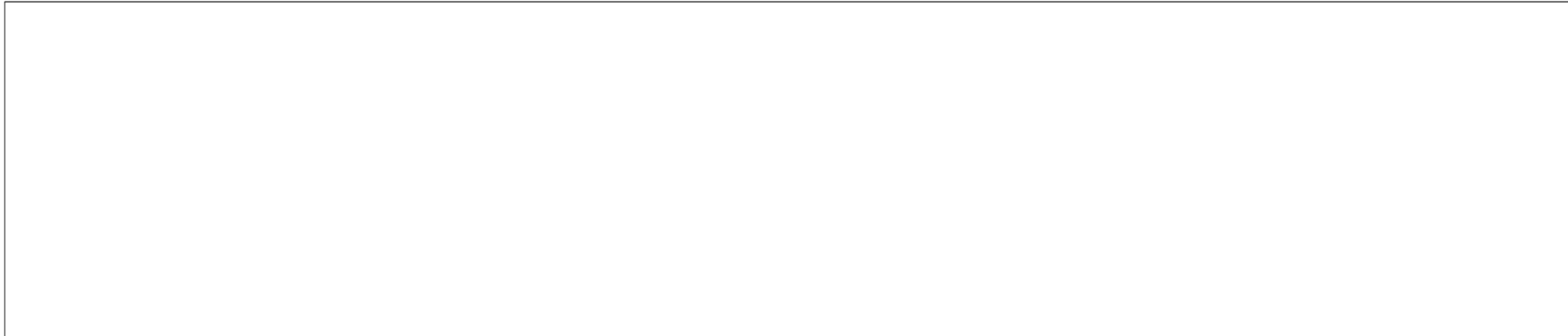
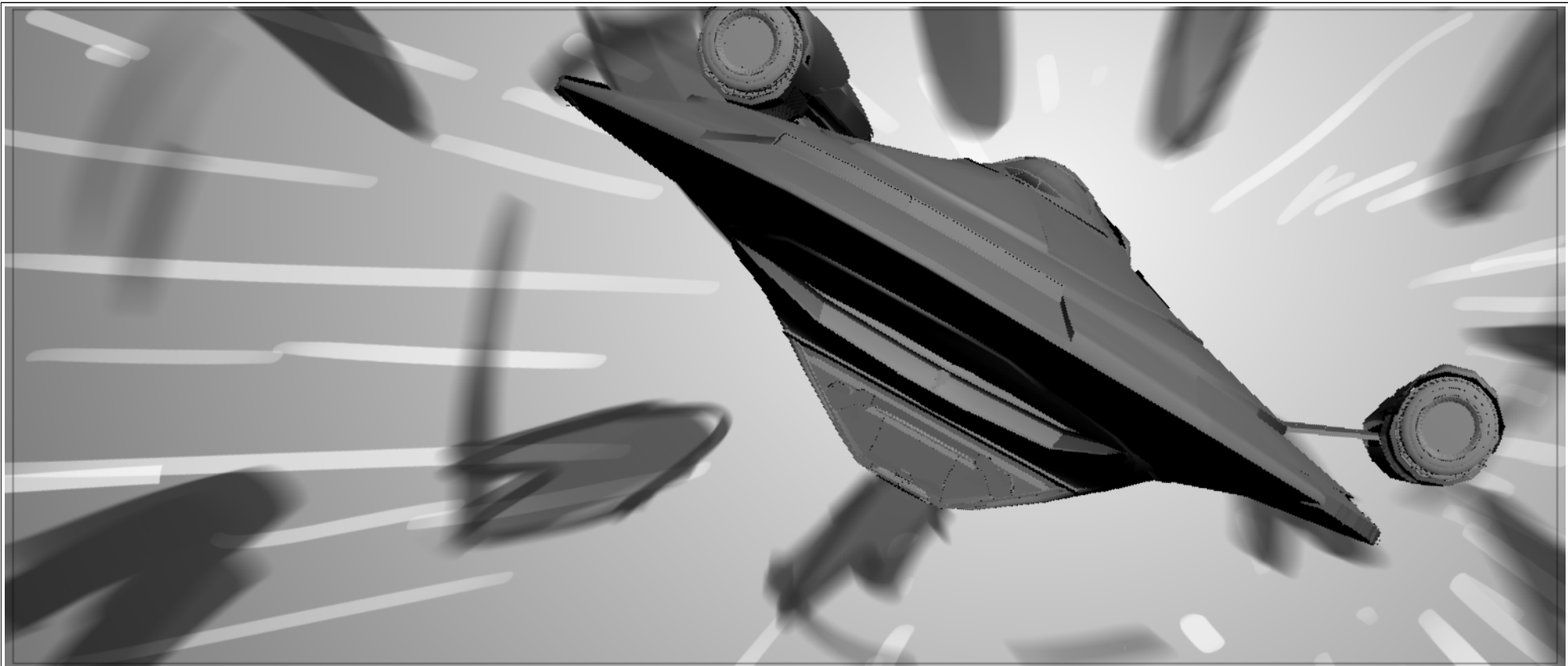

Scene	Duration	Panel	Duration
350	02:13	001C	00:05

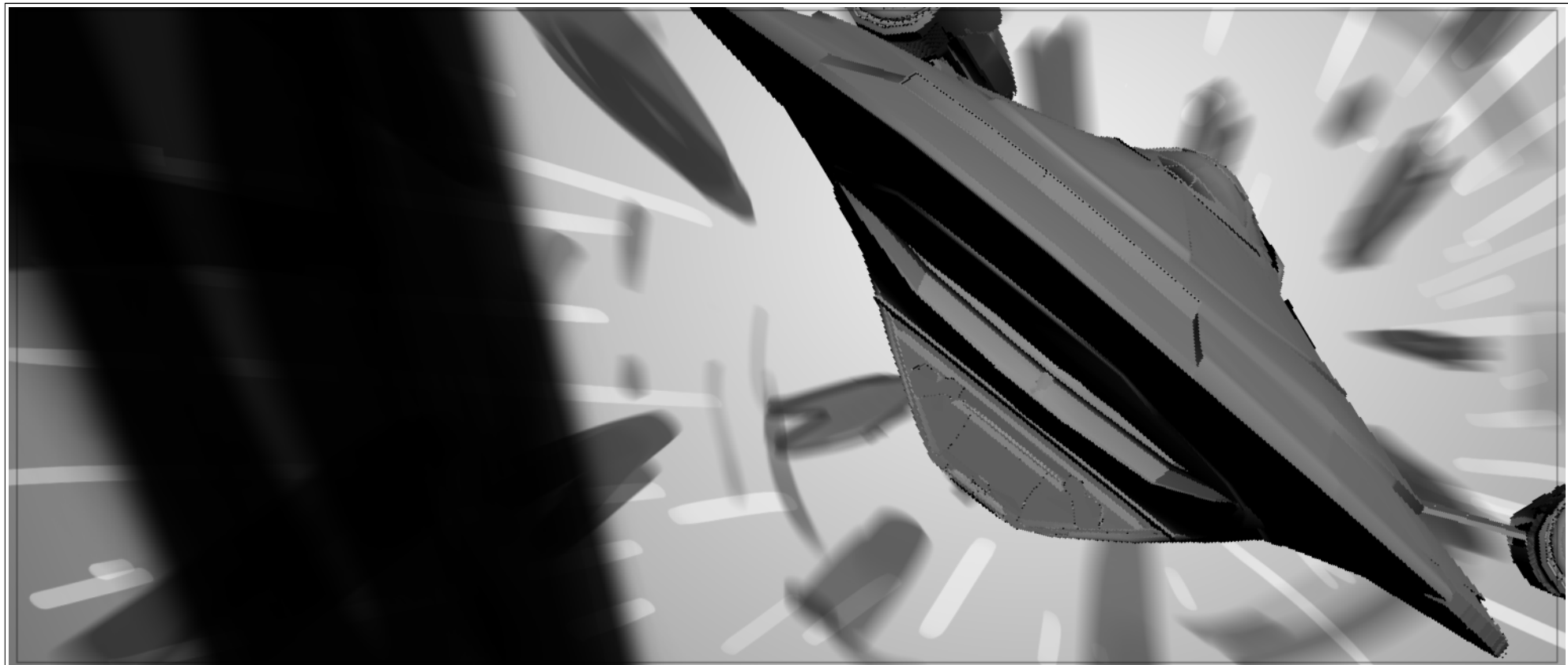

Scene	Duration	Panel	Duration
350	02:13	001M	00:05

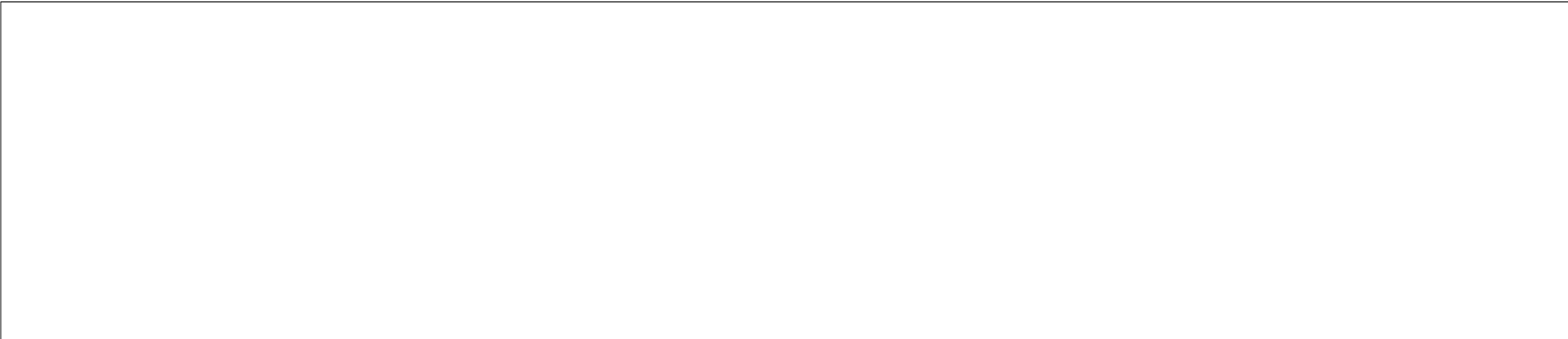
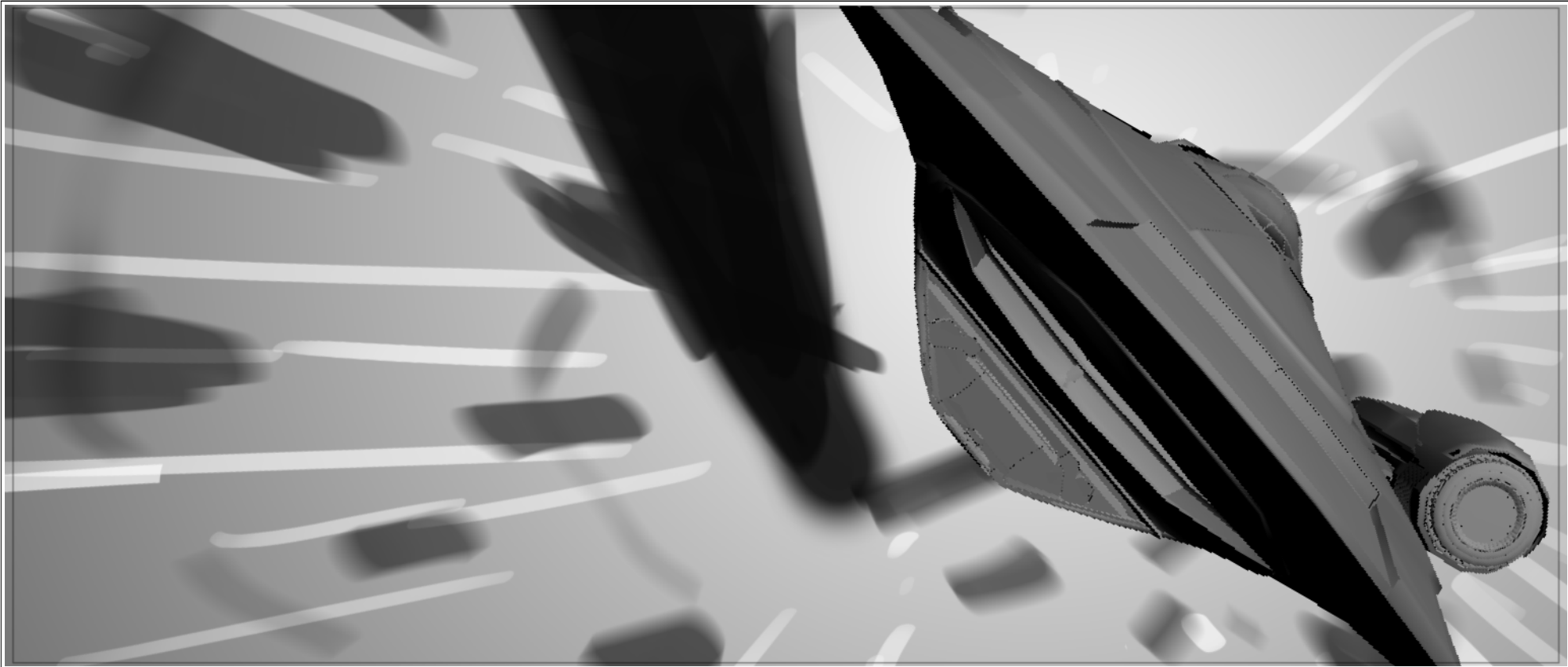

Scene	Duration	Panel	Duration
350	02:13	001N	00:04

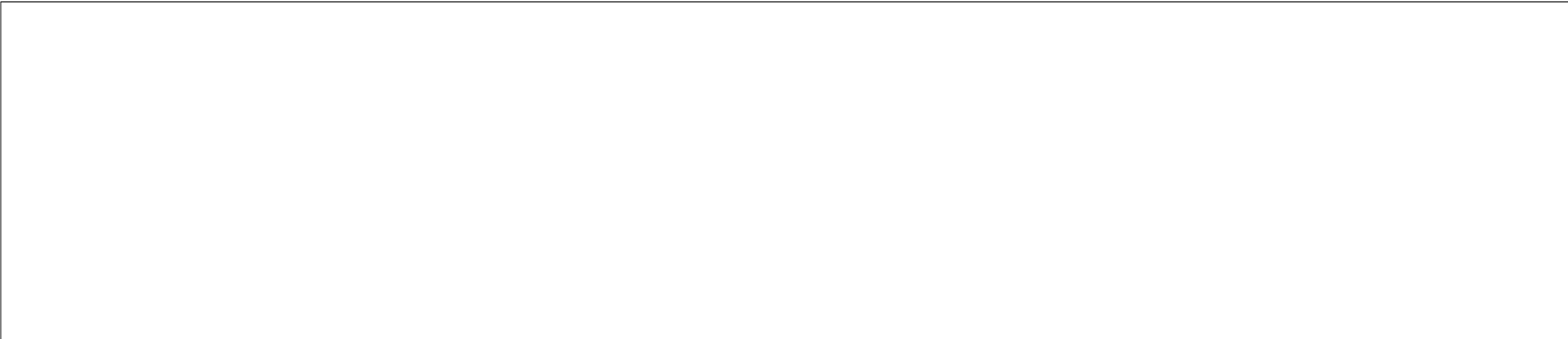
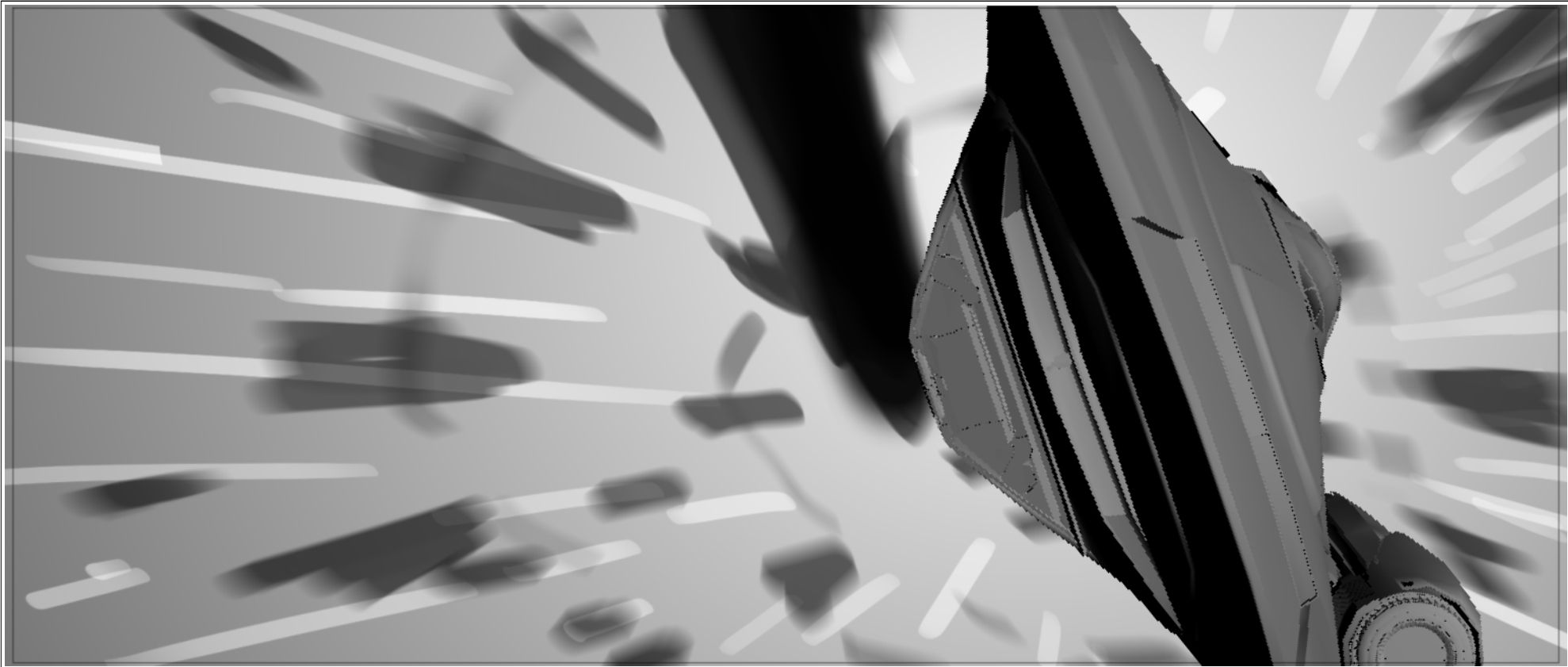

Scene	Duration	Panel	Duration
350	02:13	0010	00:04

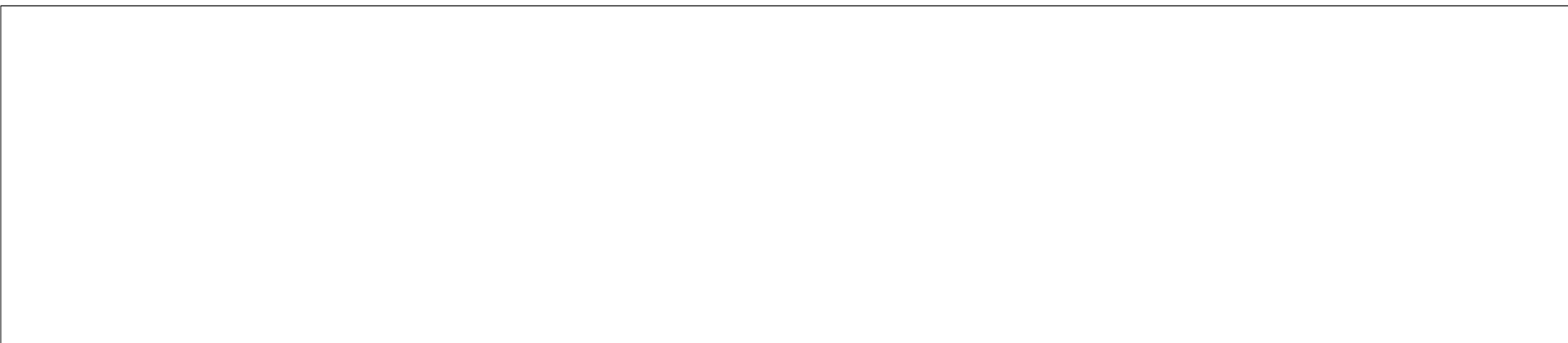
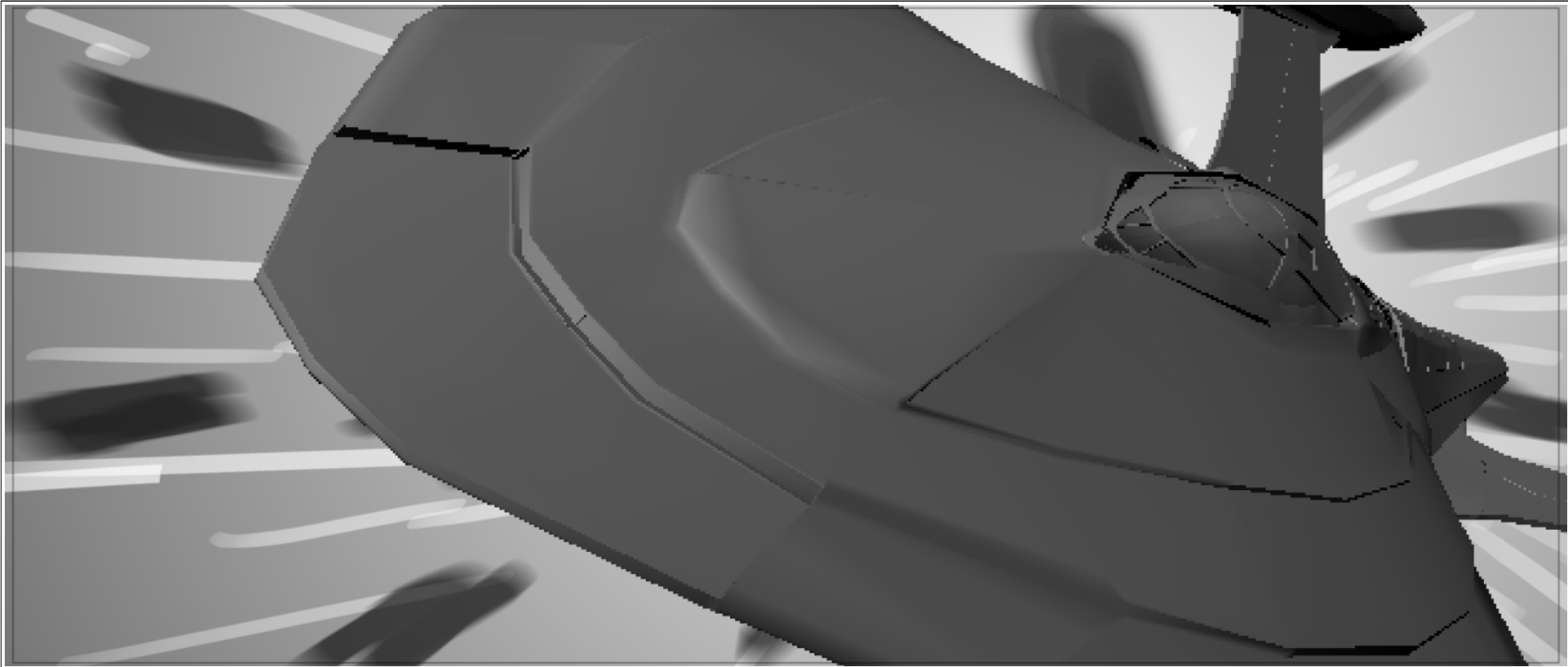

Scene	Duration	Panel	Duration
350	02:13	001D	00:04

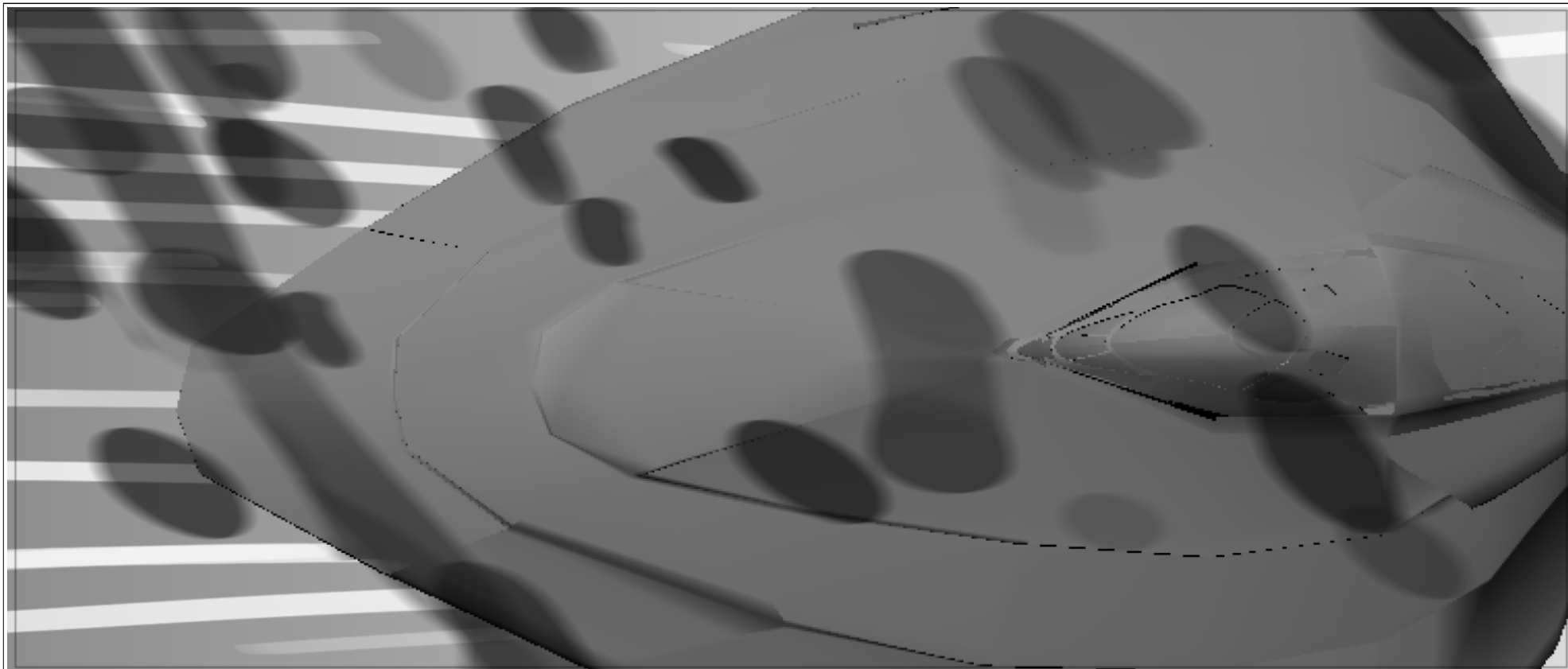

Dialog

ENSIGN GARROVICK (RECORDING) (CONT'D)

186 ?In the end... they were the ones who saved me.?

Action Notes

CAMERA FOLLOWS PROTOSTAR

Scene	Duration	Panel	Duration
350	02:13	001P	00:06

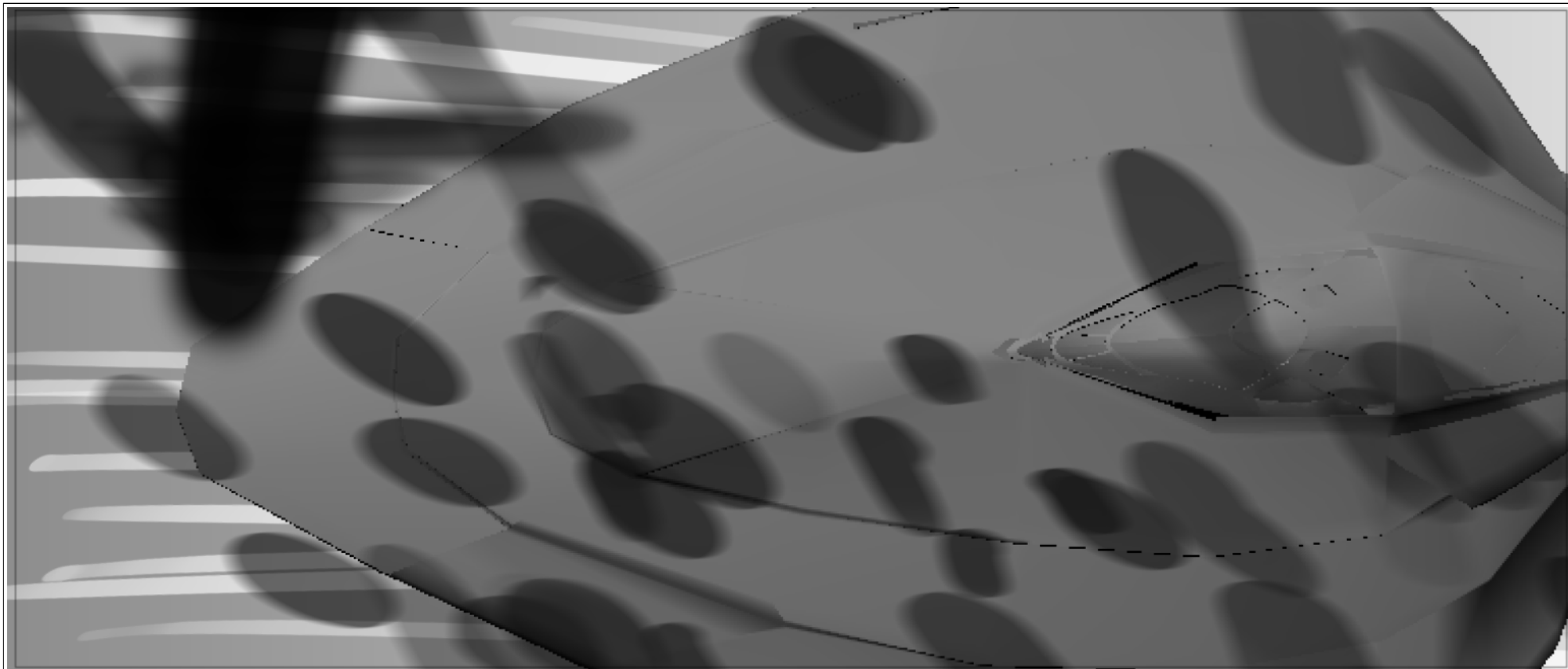

Dialog

ENSIGN GARROVICK (RECORDING) (CONT'D)

186 ?In the end... they were the ones who saved me.?

Action Notes

CAMERA FOLLOWS PROTOSTAR

Scene	Duration	Panel	Duration
350	02:13	001Q	00:05

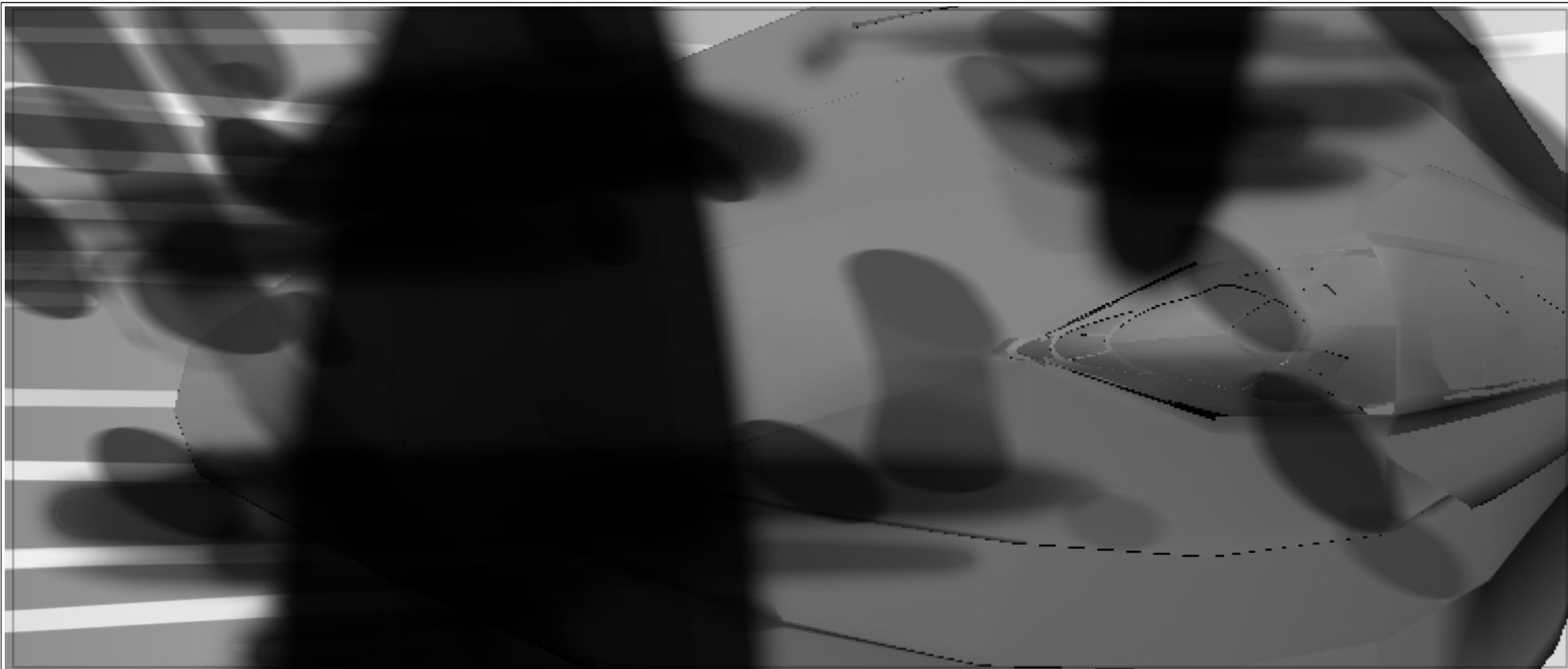

Dialog

ENSIGN GARROVICK (RECORDING) (CONT'D)

186 ?In the end... they were the ones who saved me.?

Action Notes

CAMERA FOLLOWS PROTOSTAR

Scene	Duration	Panel	Duration
350	02:13	001R	00:05

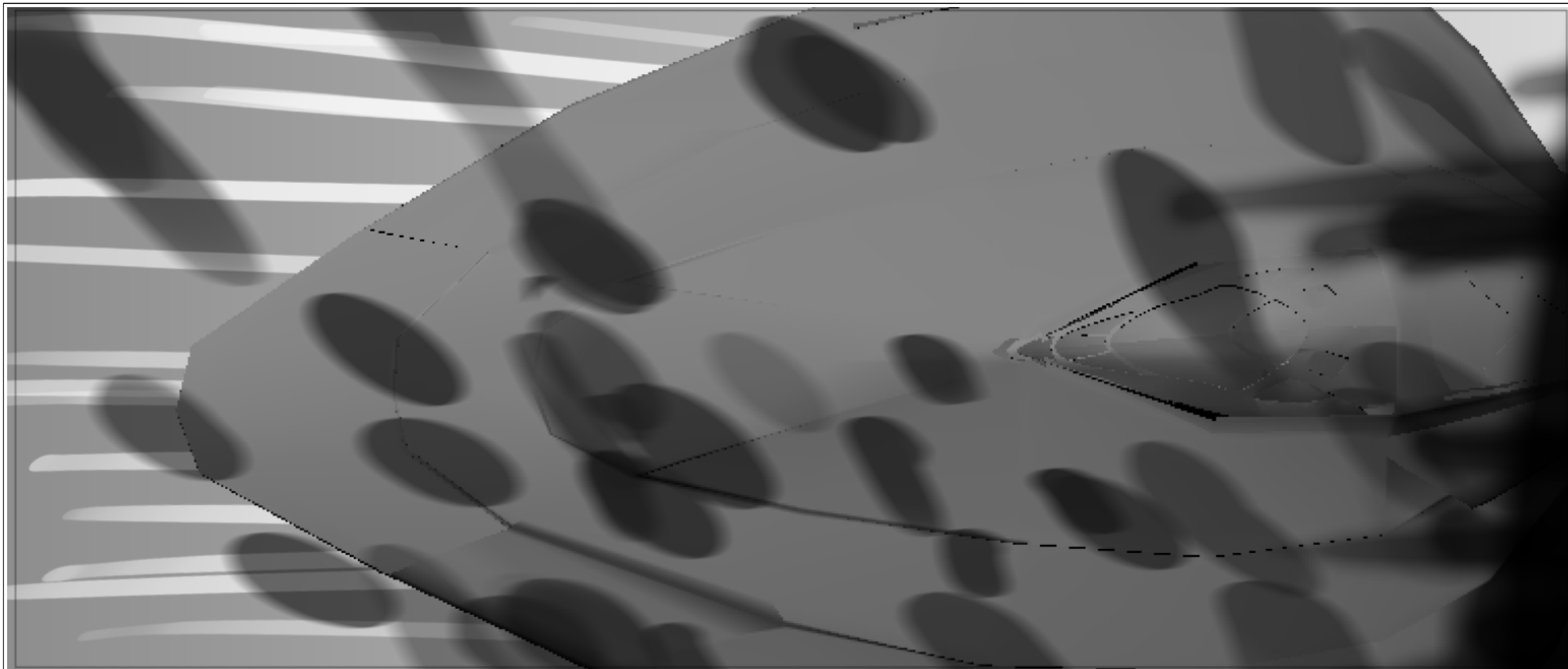

Dialog

ENSIGN GARROVICK (RECORDING) (CONT'D)

186 ?In the end... they were the ones who saved me.?

Action Notes

CAMERA FOLLOWS PROTOSTAR

Scene	Duration	Panel	Duration
350	02:13	001E	00:04

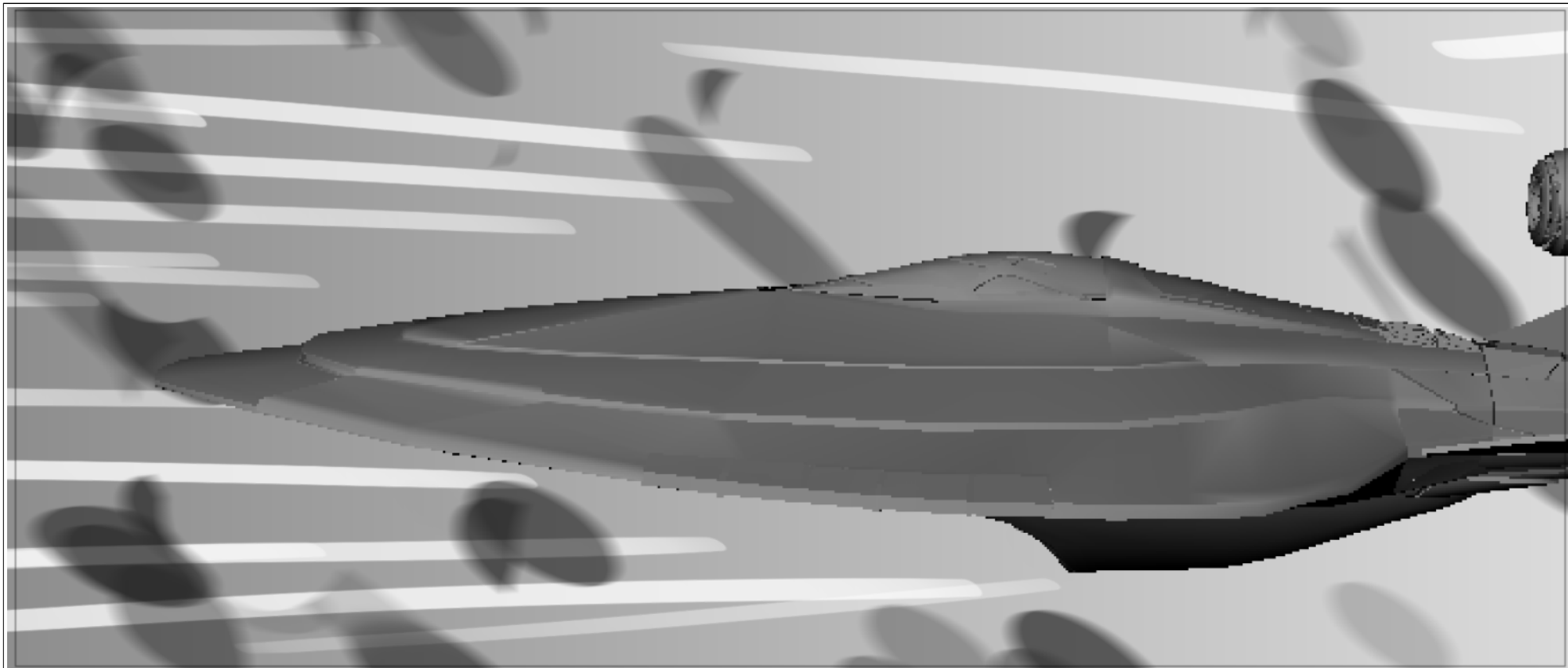

Dialog

ENSIGN GARROVICK (RECORDING) (CONT'D)

186 ?In the end... they were the ones who saved me.?

Scene	Duration	Panel	Duration
350	02:13	001T	00:04

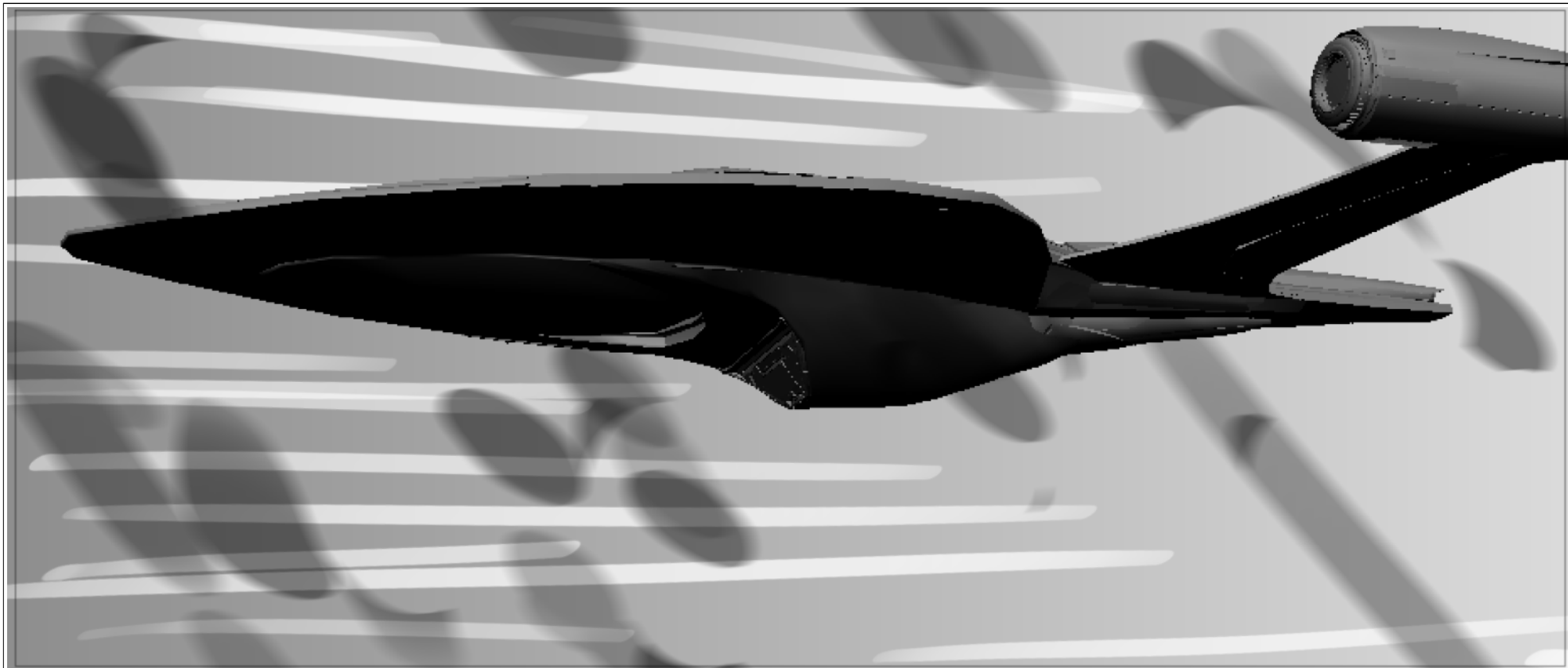

Dialog

ENSIGN GARROVICK (RECORDING) (CONT'D)

186 ?In the end... they were the ones who saved me.?

Scene	Duration	Panel	Duration
350	02:13	001S	00:05

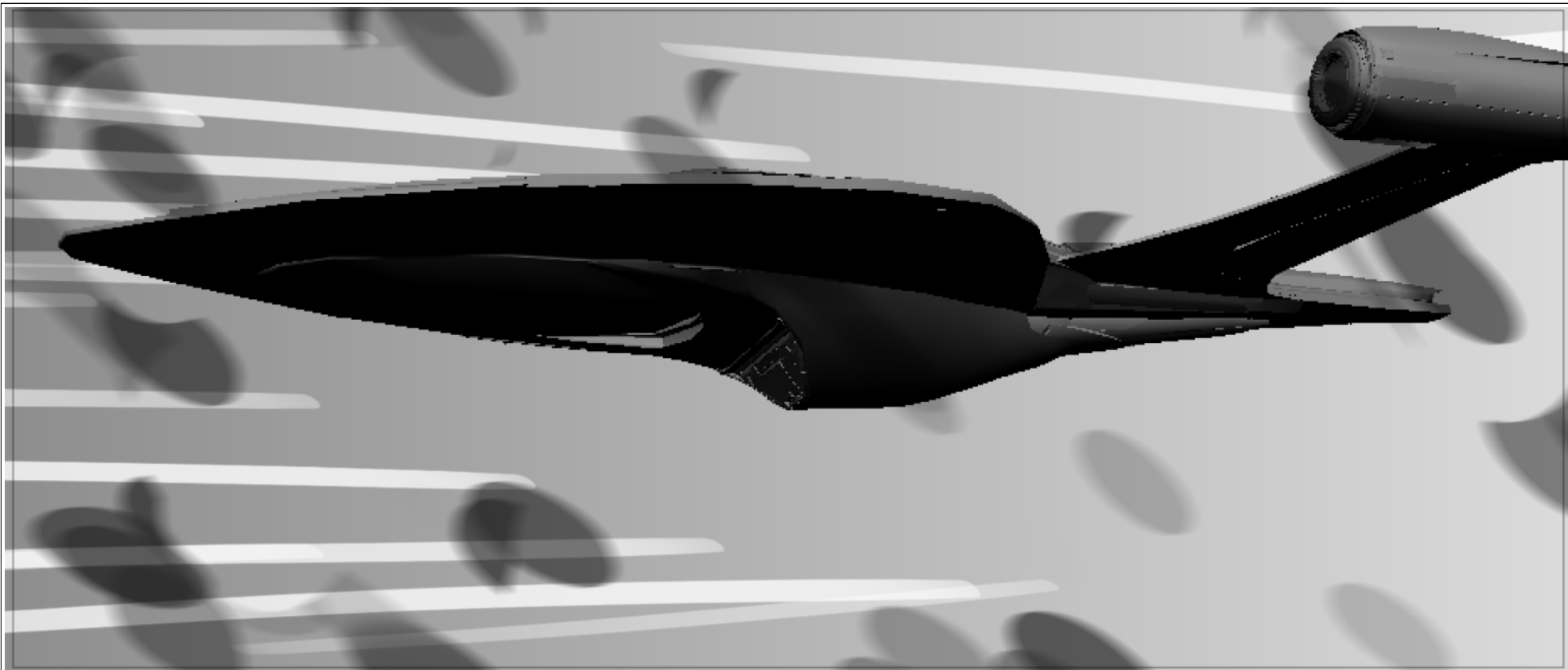

Dialog

ENSIGN GARROVICK (RECORDING) (CONT'D)

186 ?In the end... they were the ones who saved me.?

Scene	Duration	Panel	Duration
350	02:13	001U	00:06

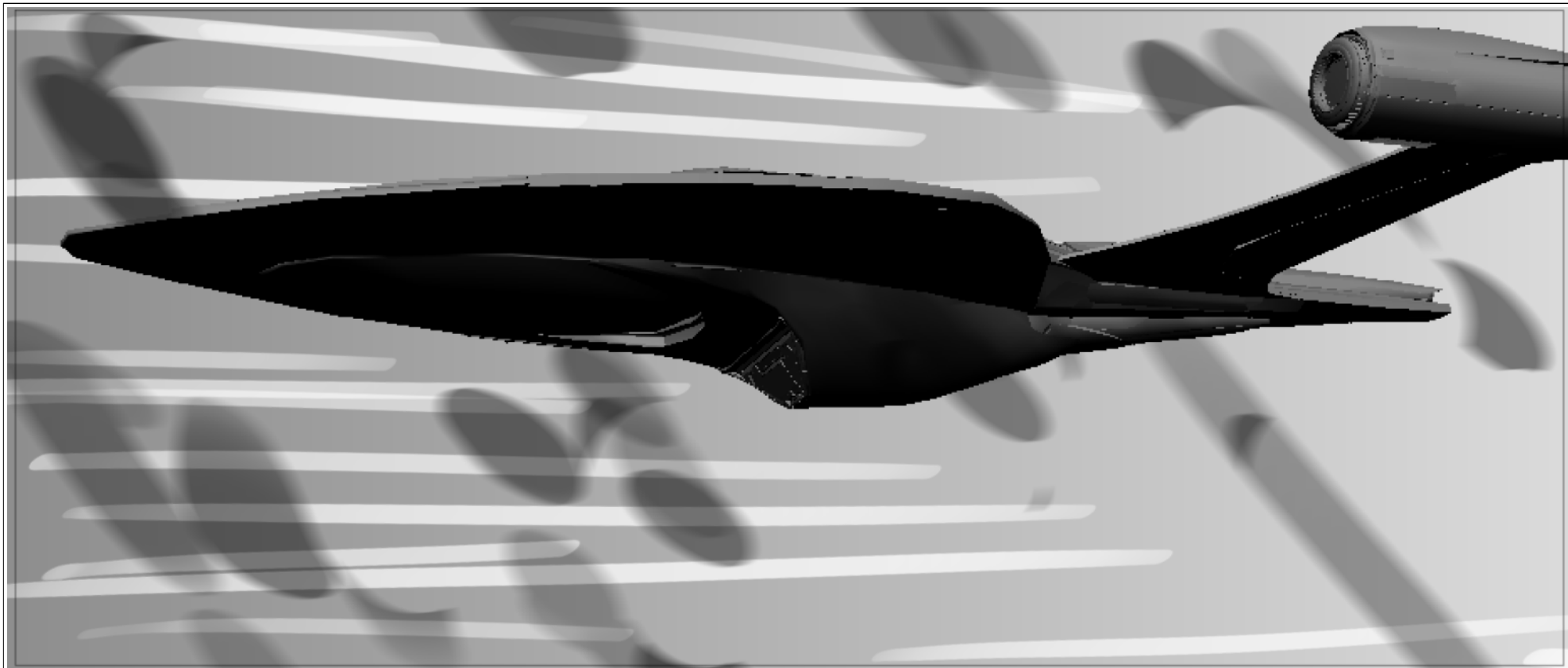

Dialog

ENSIGN GARROVICK (RECORDING) (CONT'D)

186 ?In the end... they were the ones who saved me.?

Scene	Duration	Panel	Duration
360	00:11	001V	00:11

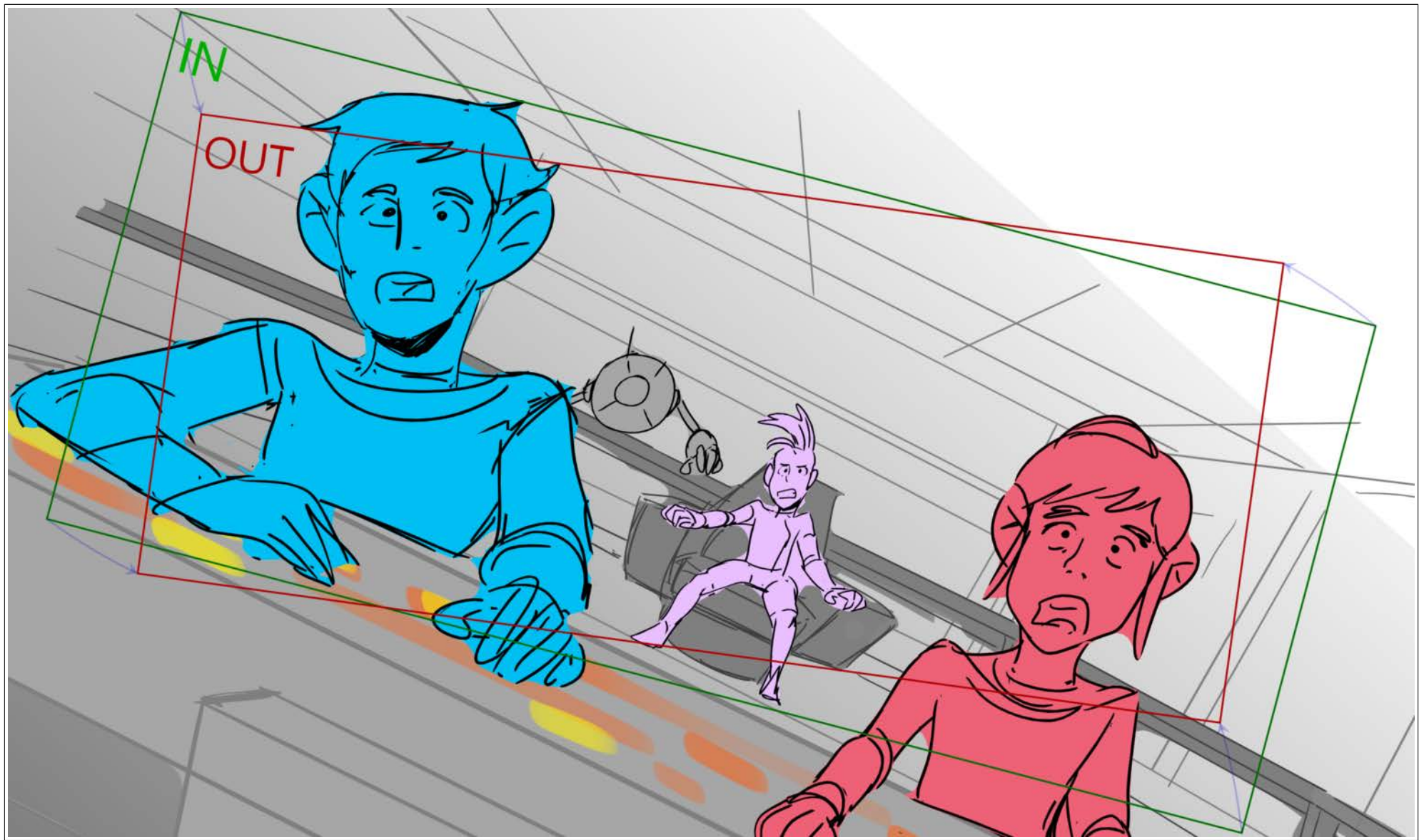

Dialog

ENSIGN GARROVICK (RECORDING) (CONT'D)
186 ?in the end... they were the ones who saved me.?

Action Notes

CAMERA SHAKE

Scene	Duration	Panel	Duration
365	00:17	001	00:17

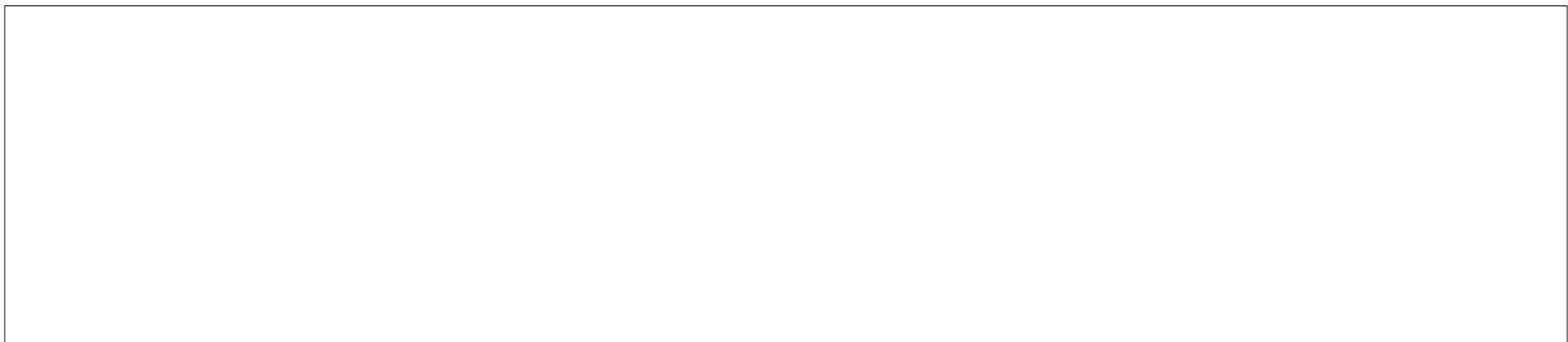
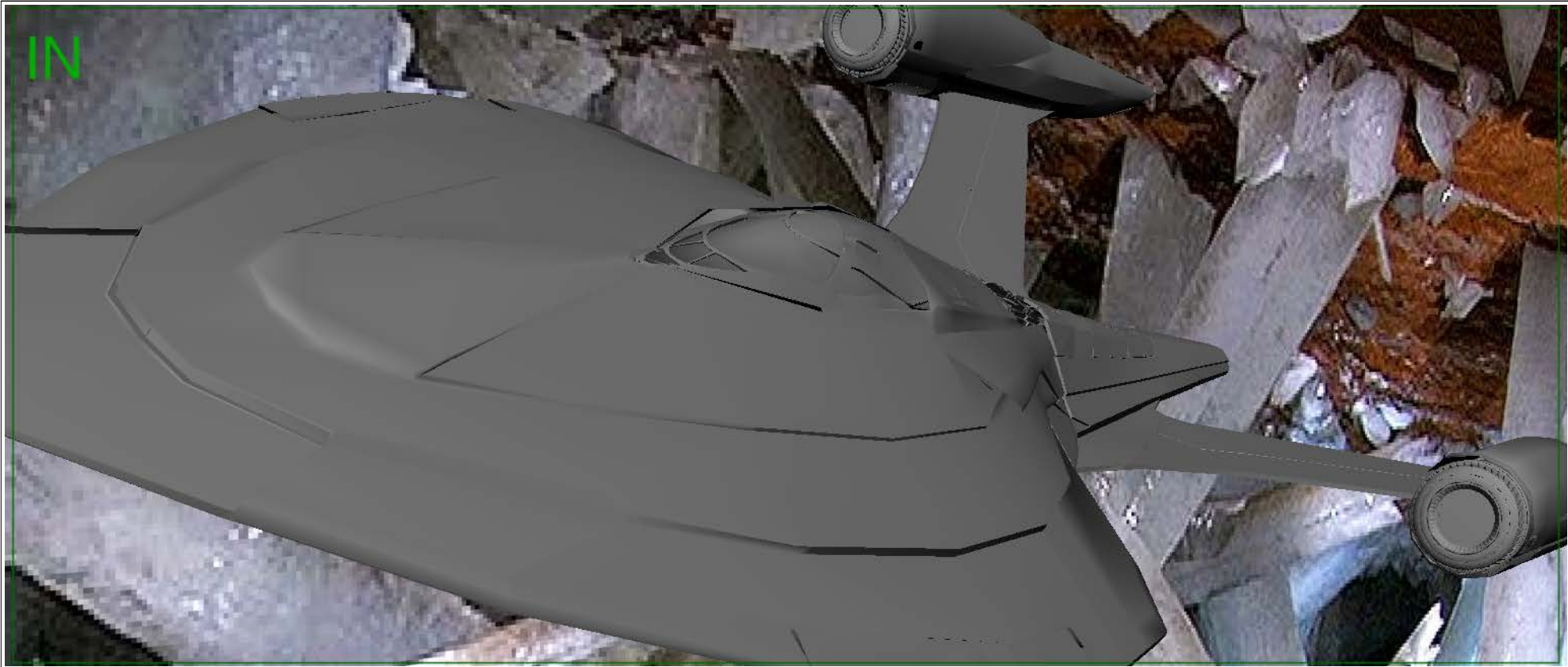

Scene	Duration	Panel	Duration
365	00:17	001	00:17

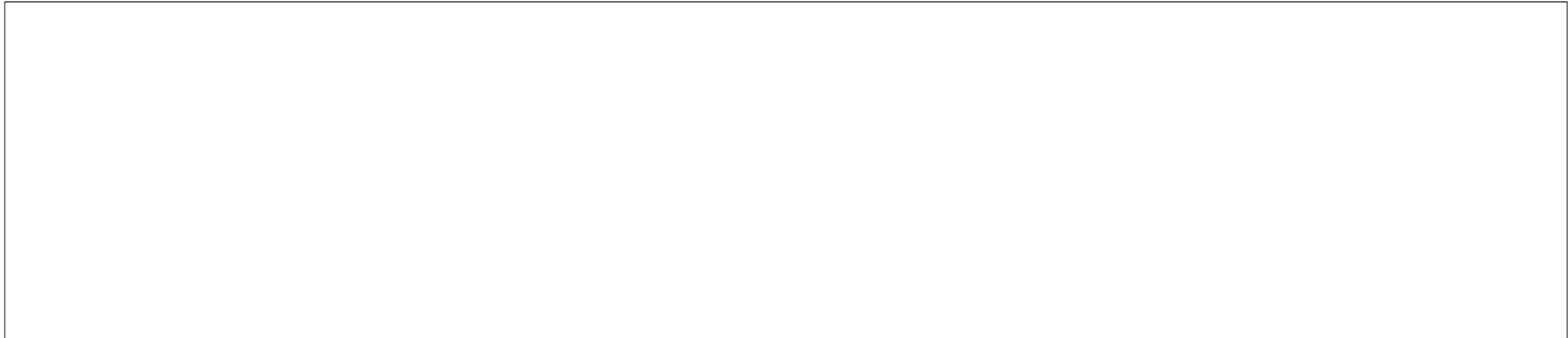

Scene	Duration	Panel	Duration
367	01:03	001	01:03

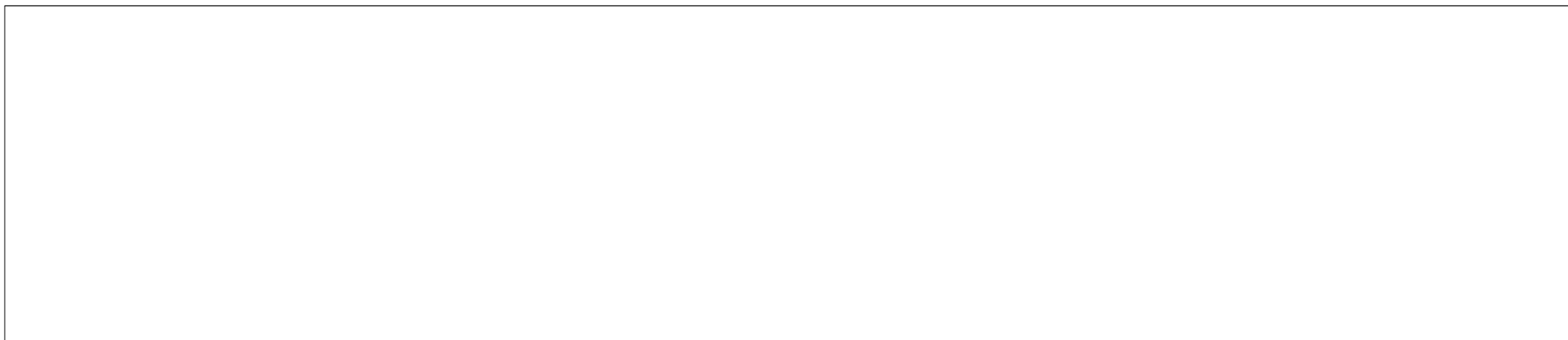
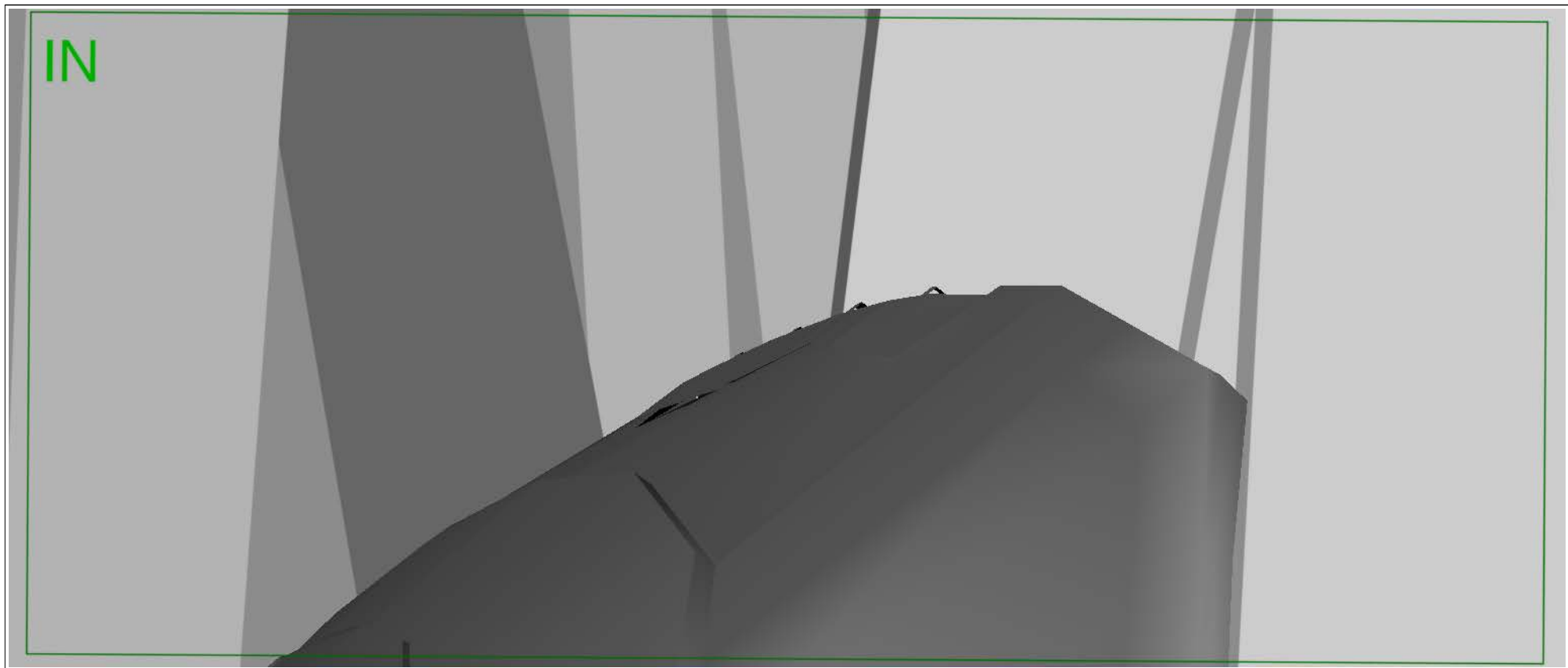

Scene	Duration	Panel	Duration
367	01:03	001	01:03

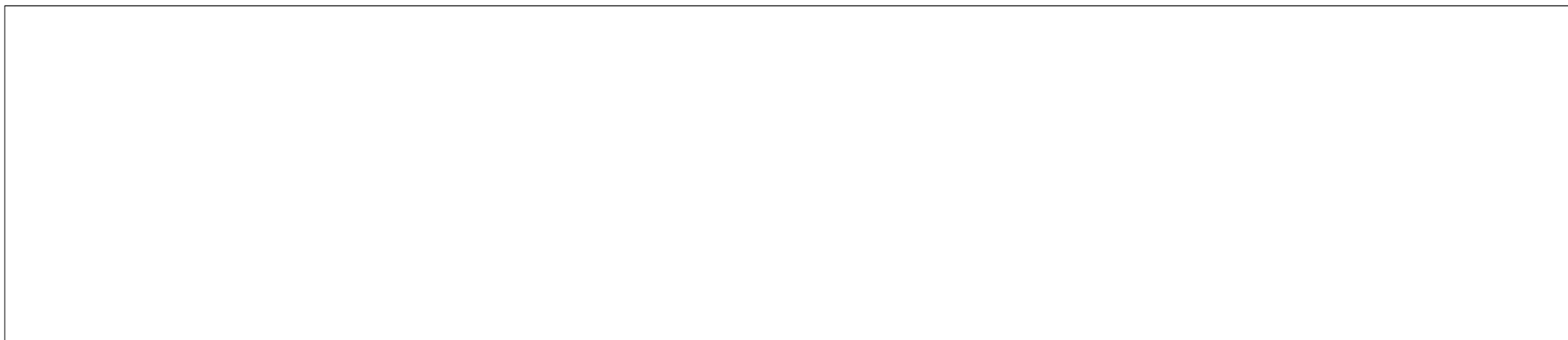
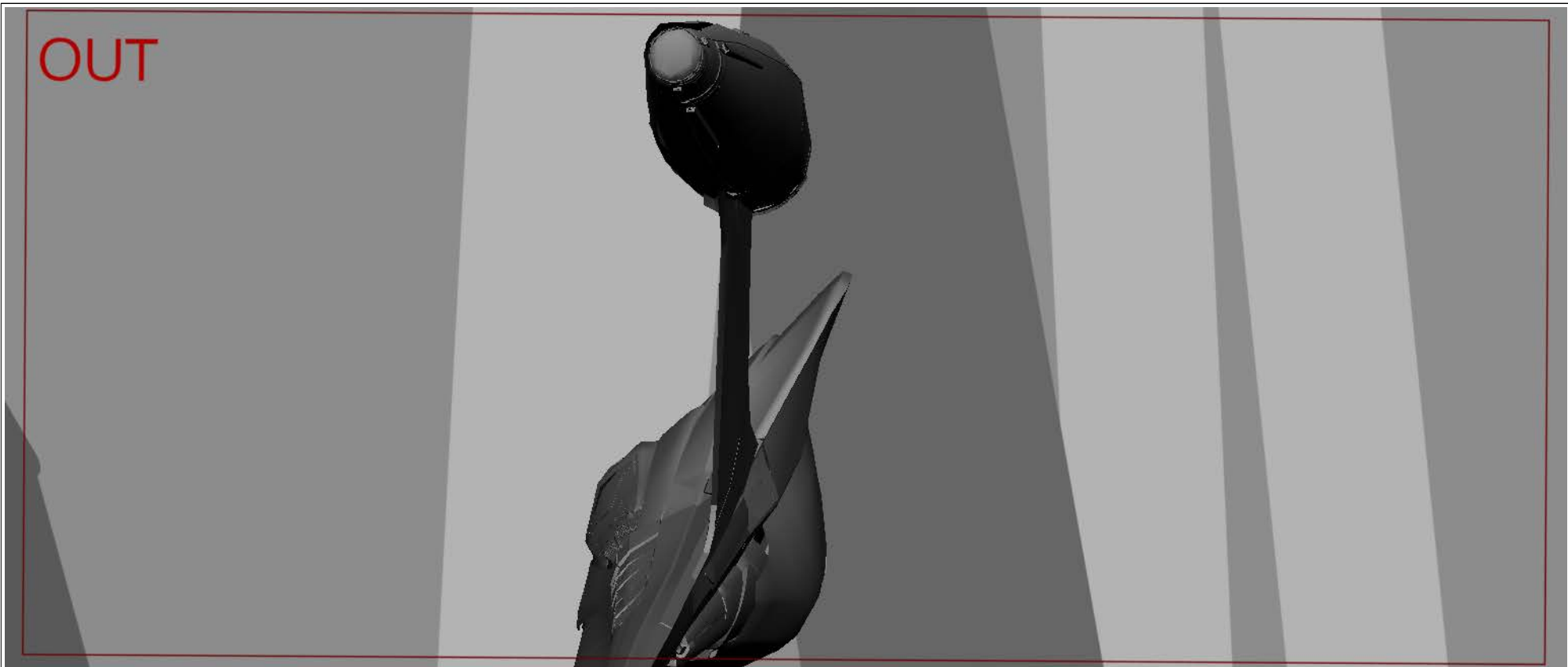

Scene	Duration	Panel	Duration
380	01:06	001	00:03

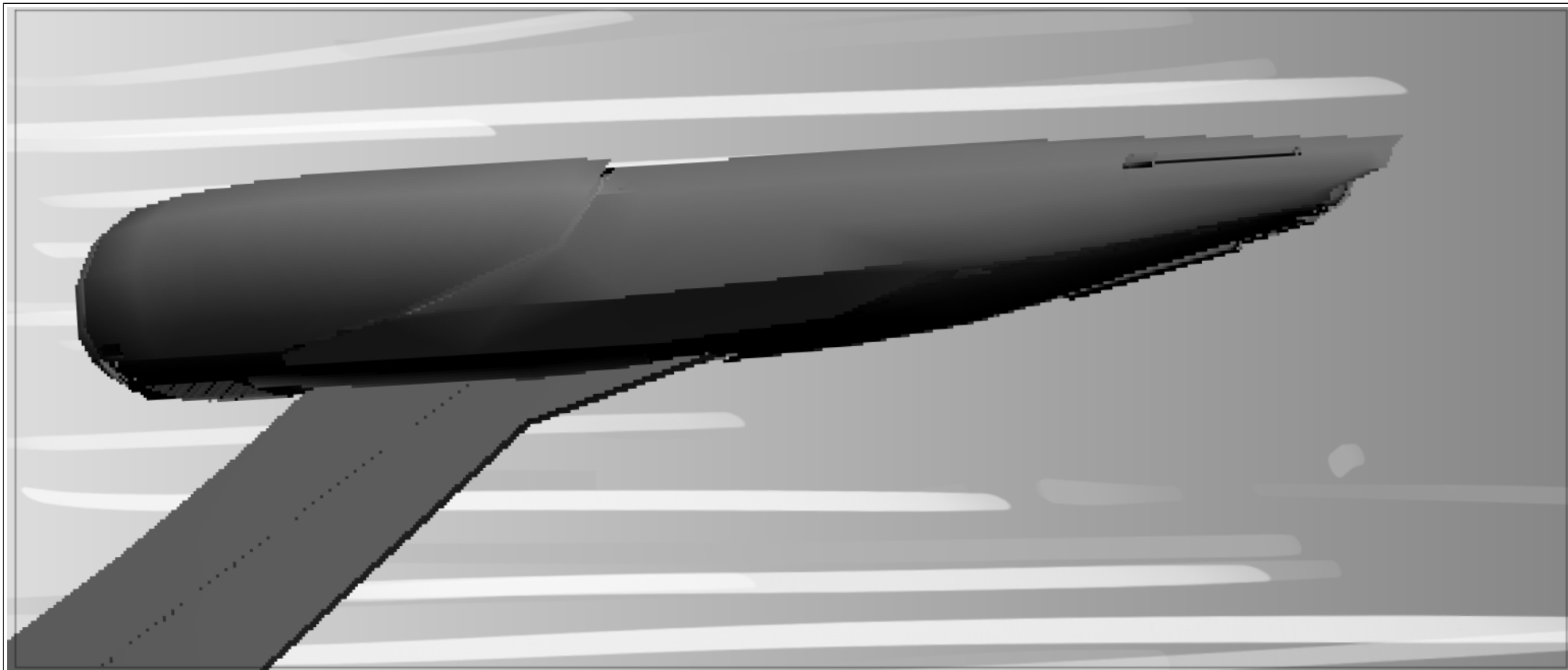

Action Notes

NACELLE SCRAPES ON WALL

Scene	Duration	Panel	Duration
380	01:06	001A0	00:03

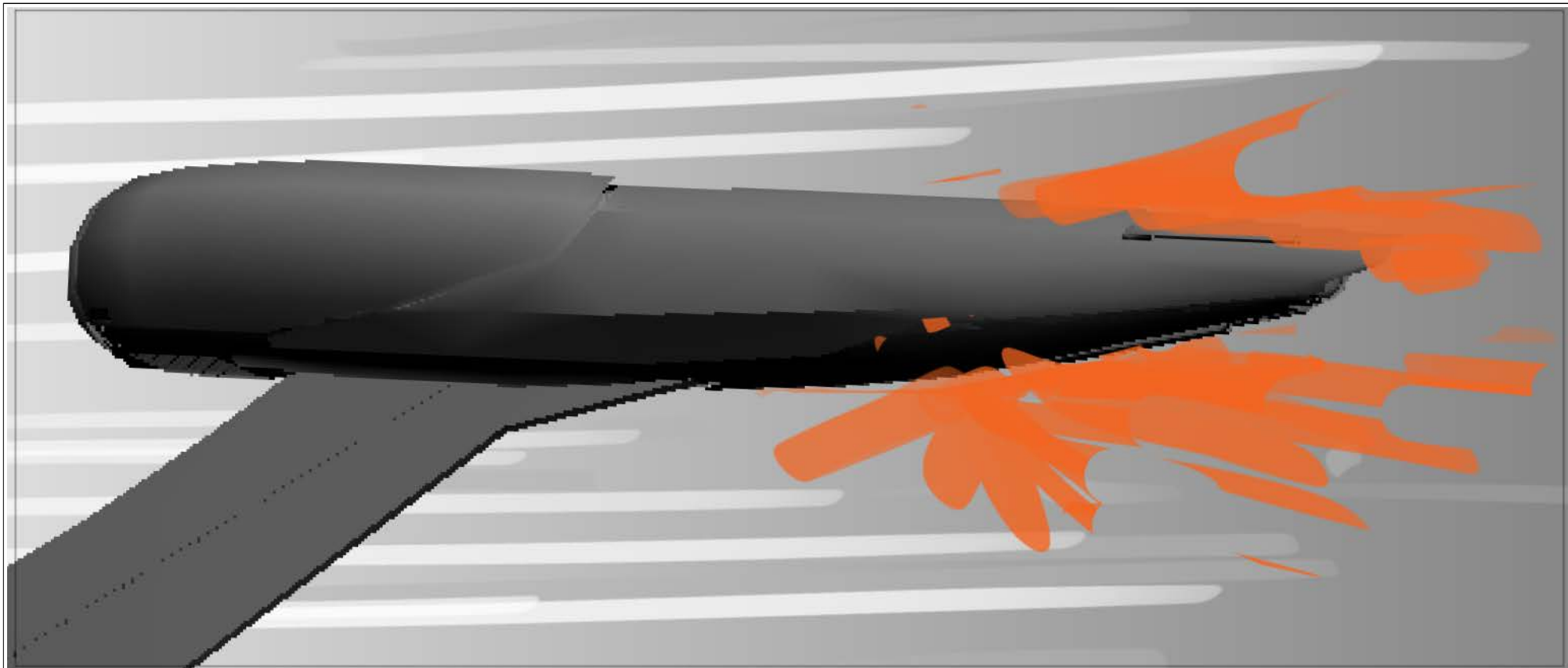

Action Notes

NACELLE SCRAPES ON WALL

Scene	Duration	Panel	Duration
380	01:06	001A1	00:03

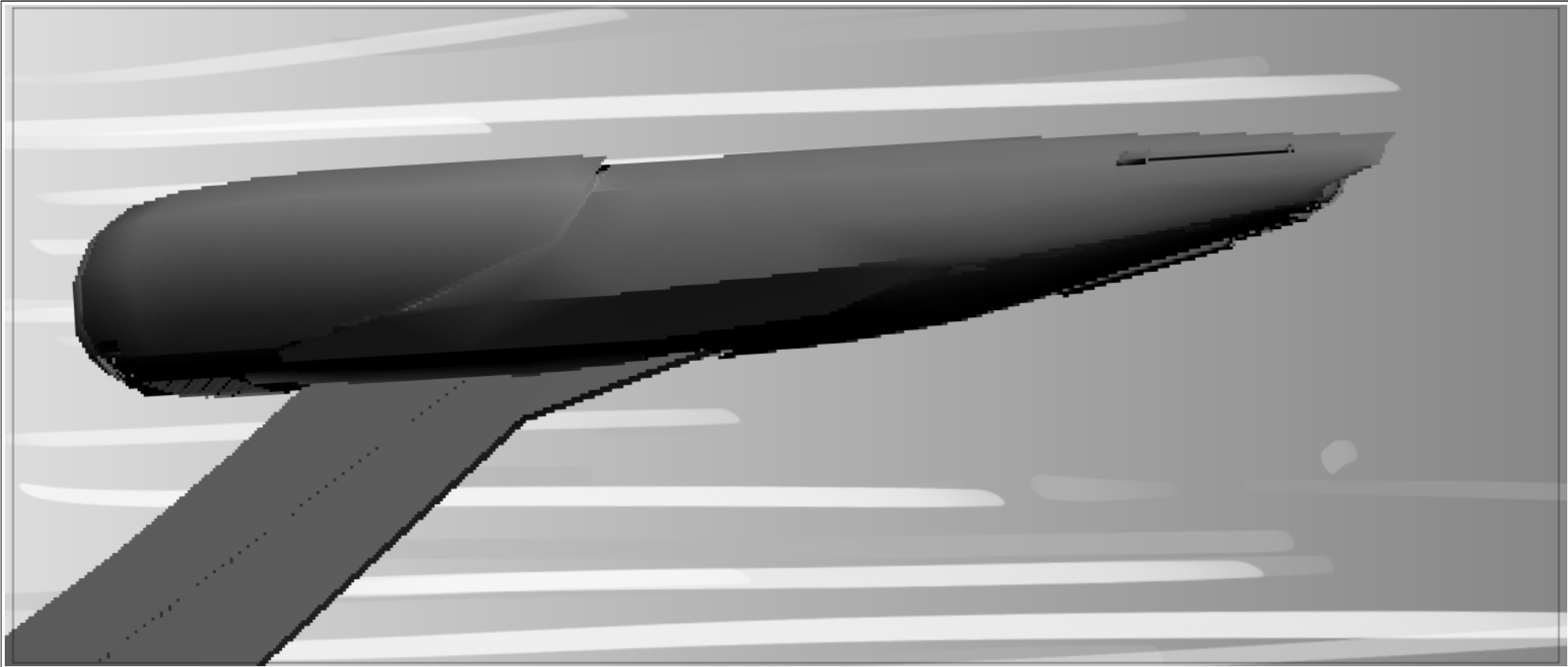

Action Notes

NACELLE SCRAPES ON WALL

Scene	Duration	Panel	Duration
380	01:06	001A2	00:03

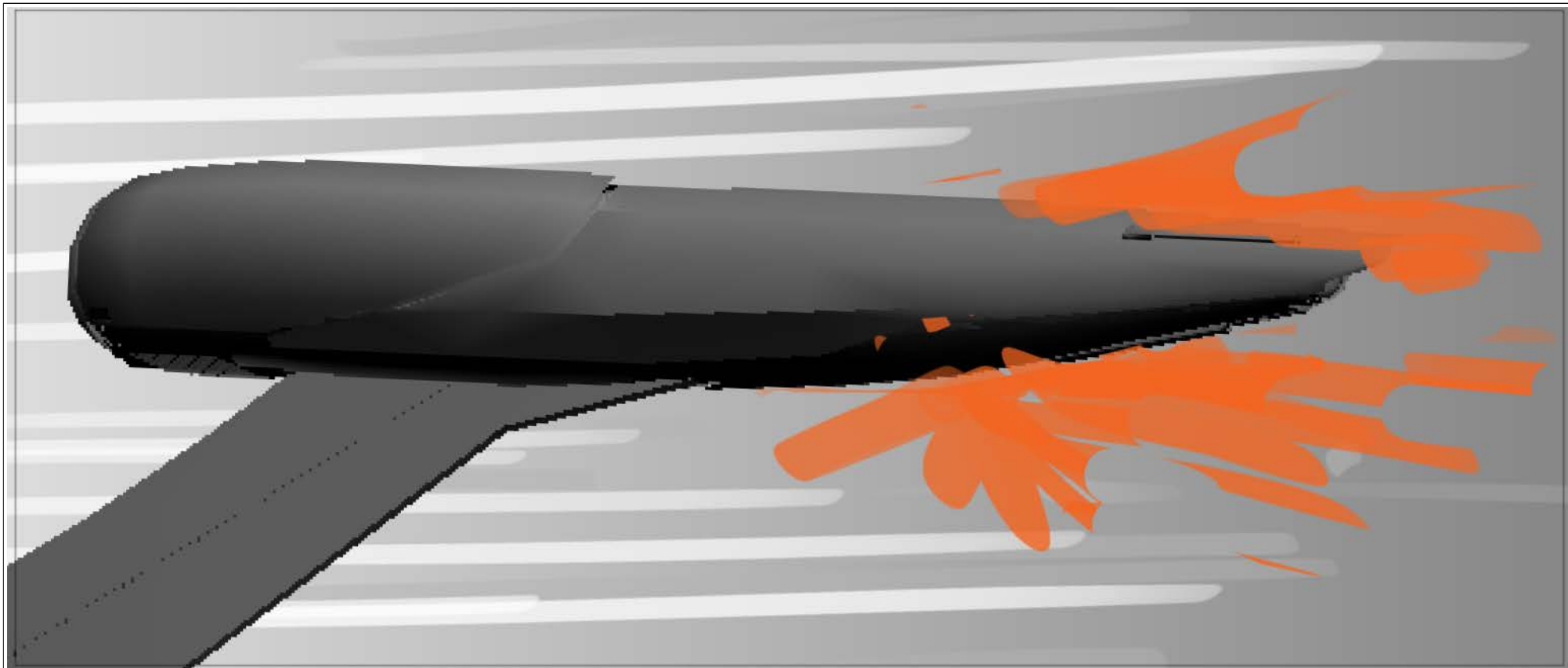

Action Notes

NACELLE SCRAPES ON WALL

Scene	Duration	Panel	Duration
380	01:06	001A	00:03

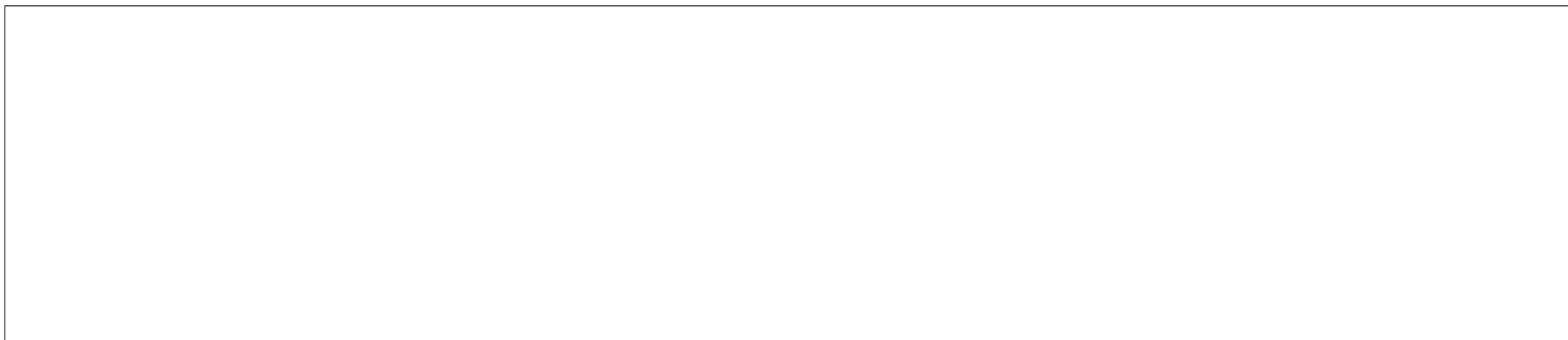
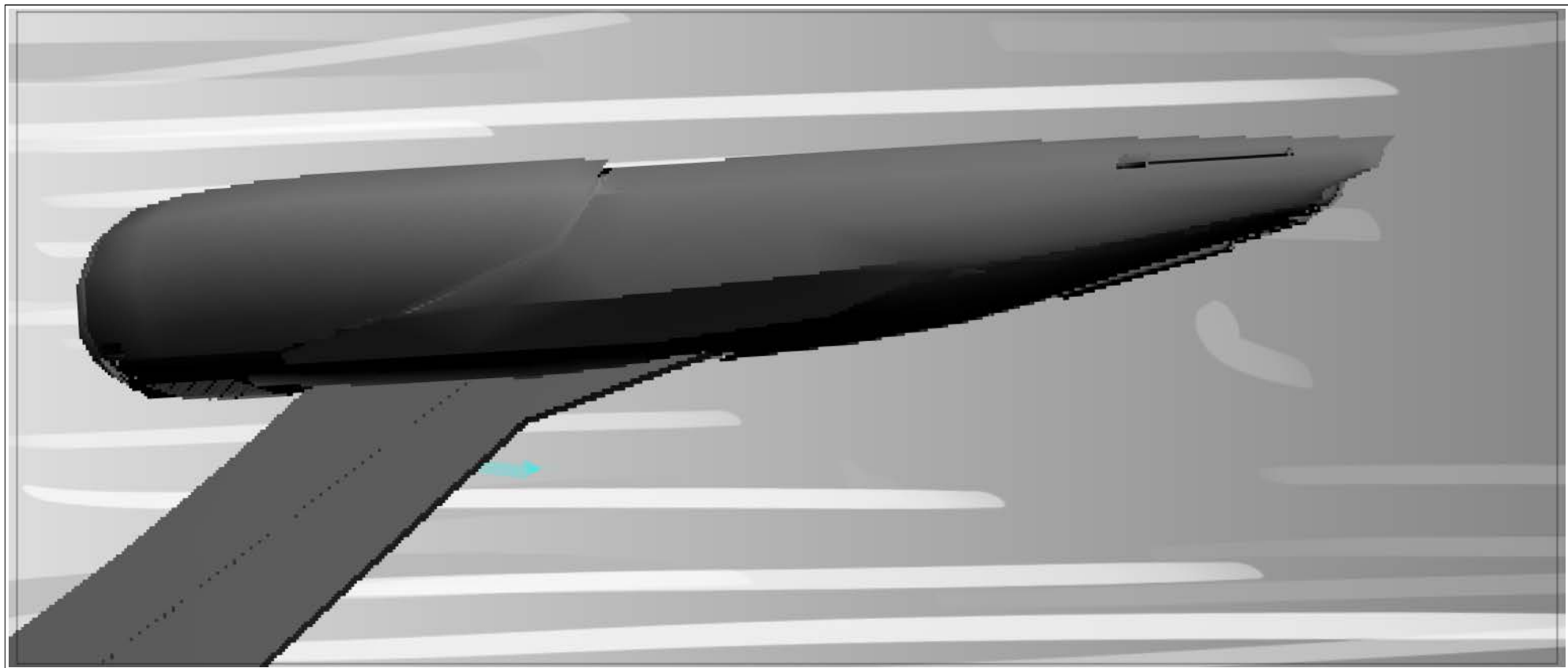

Scene	Duration	Panel	Duration
380	01:06	02A	00:03

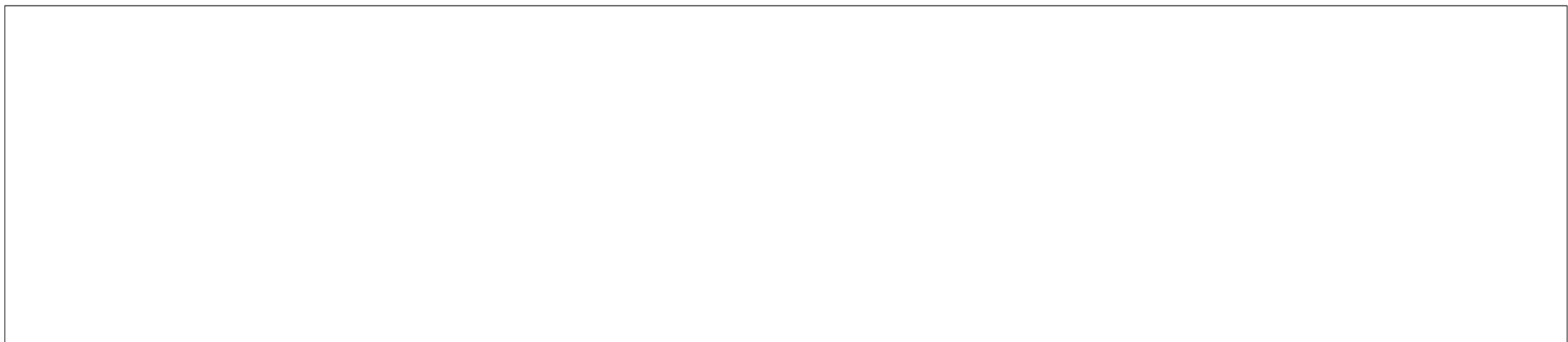
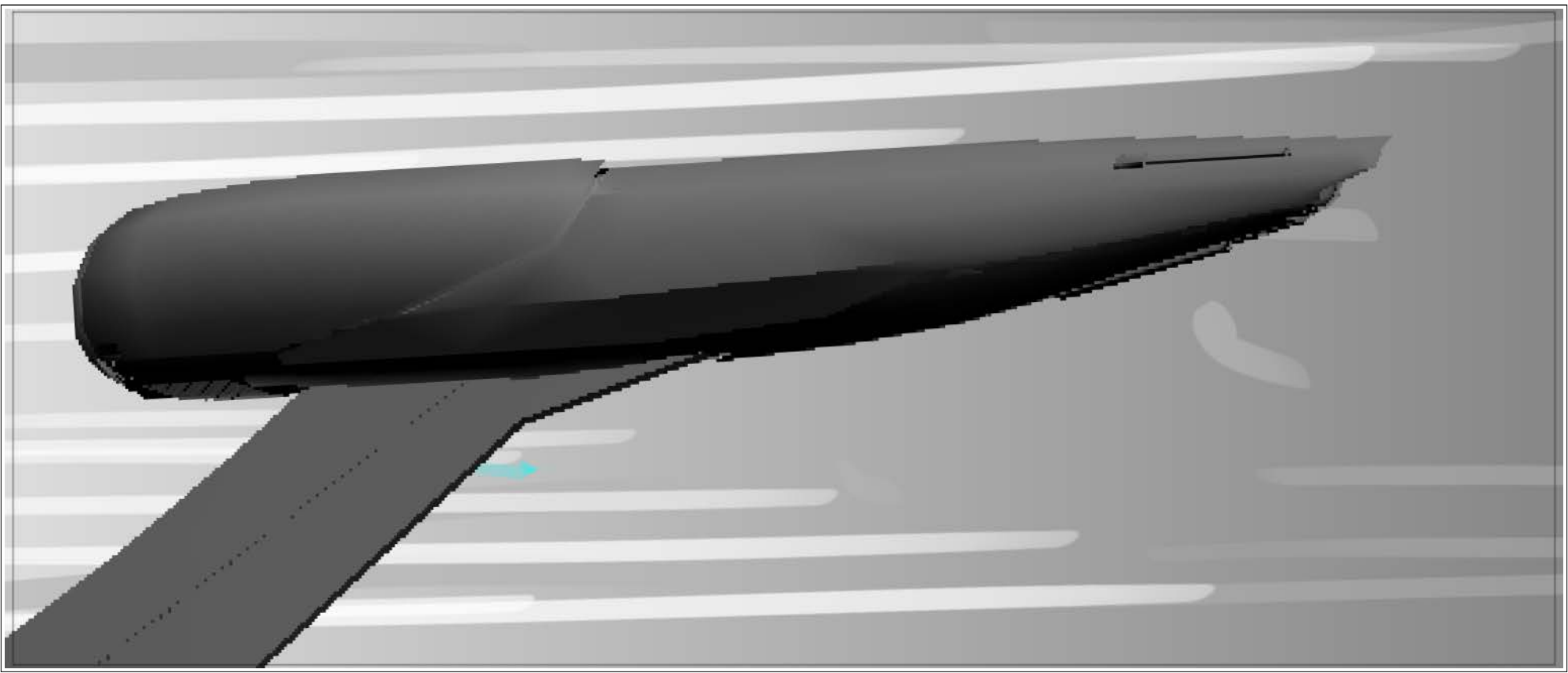

Scene	Duration	Panel	Duration
380	01:06	03A	00:03

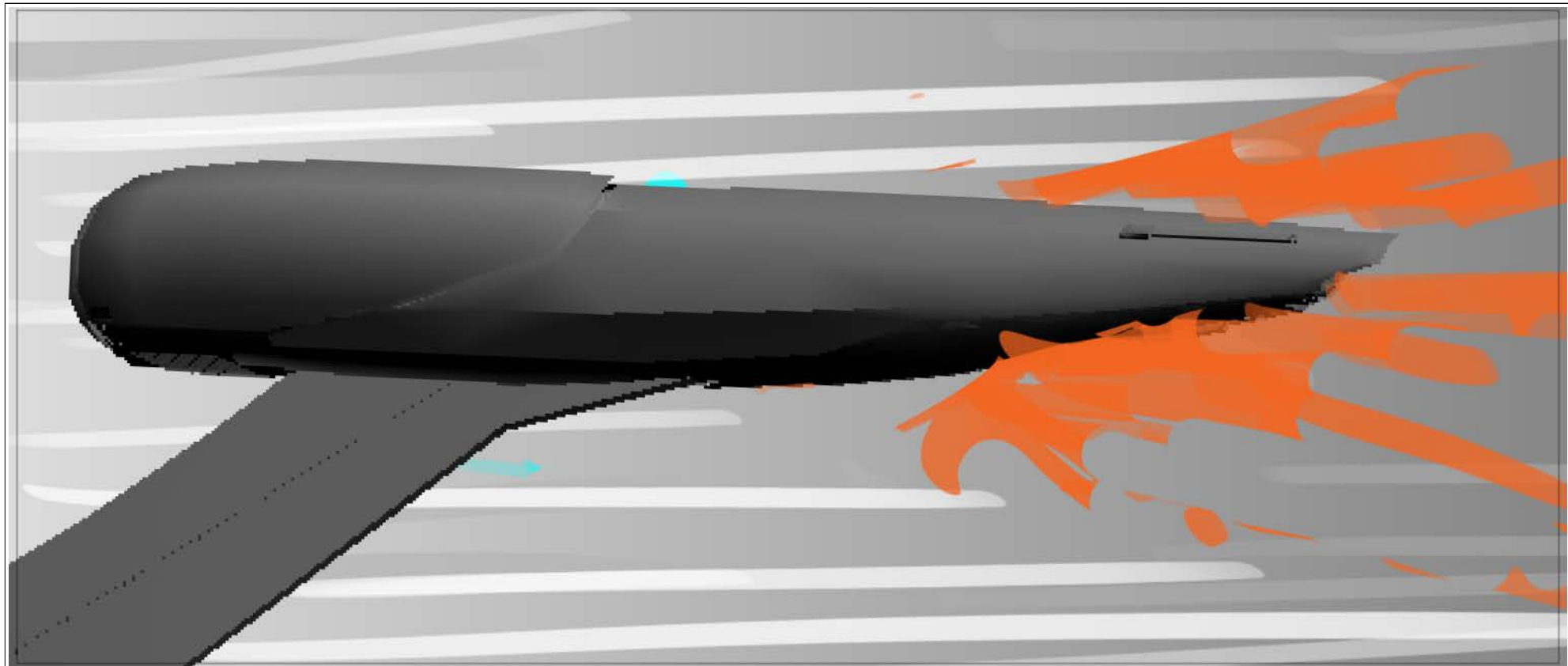

Scene	Duration	Panel	Duration
380	01:06	04A	00:03

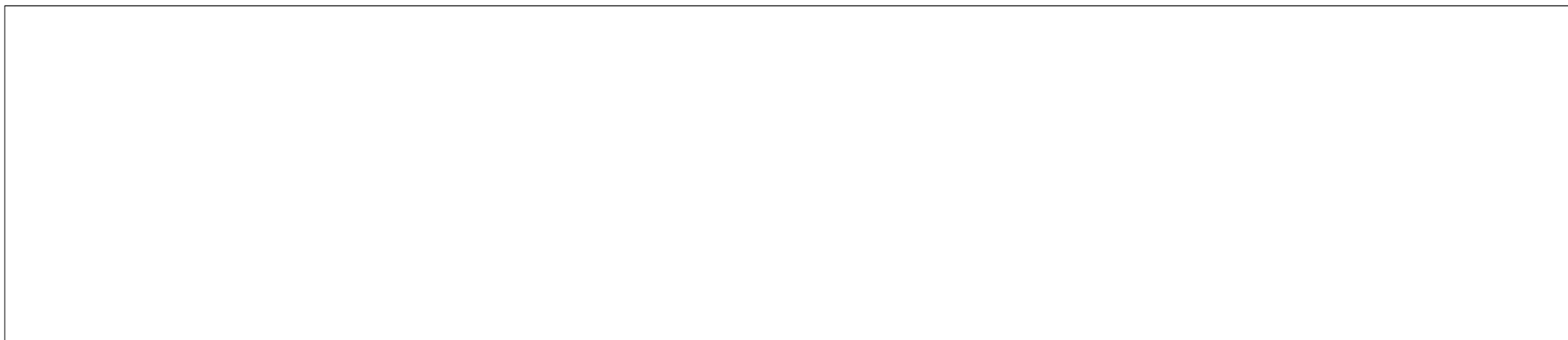
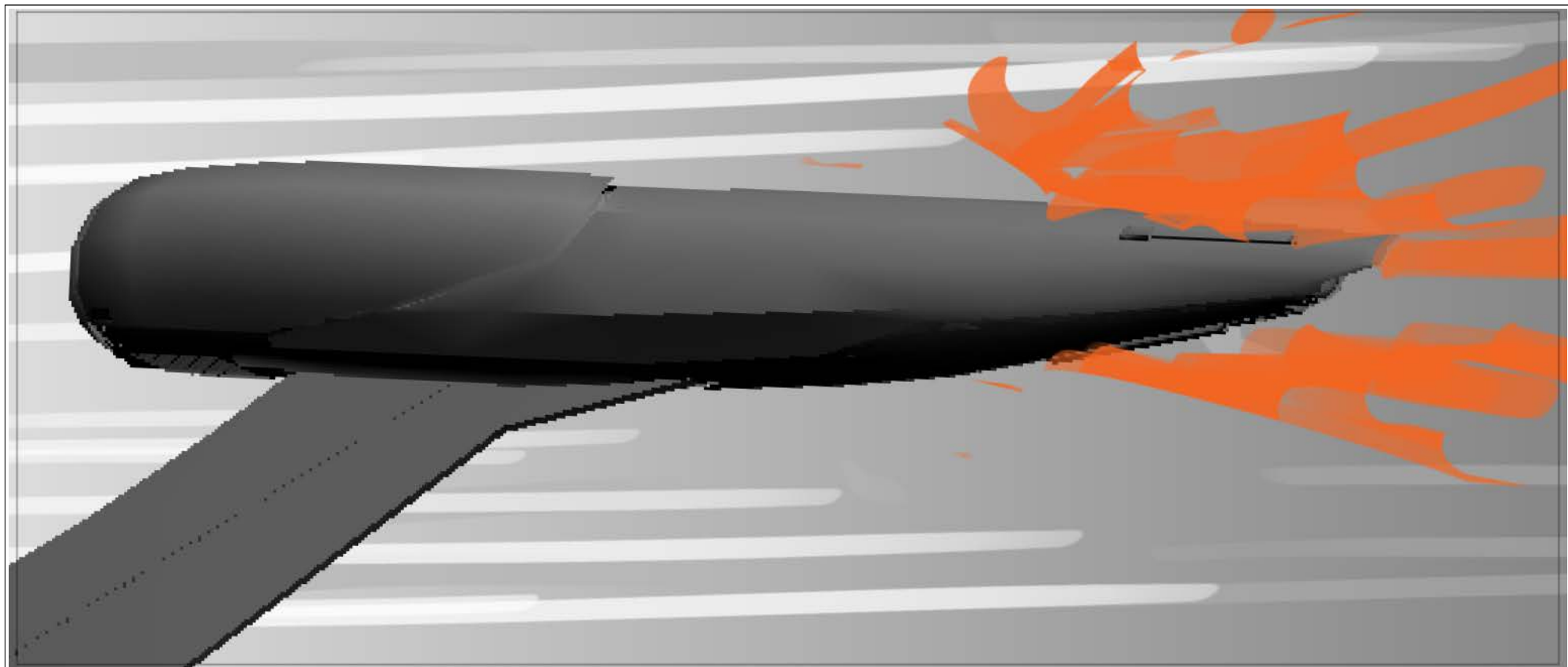

Scene	Duration	Panel	Duration
380	01:06	001B	00:03

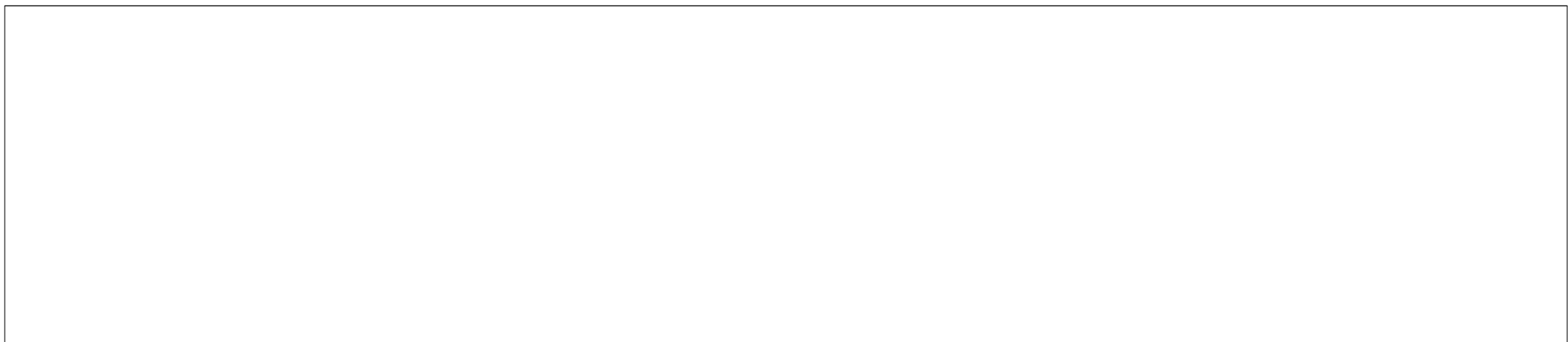
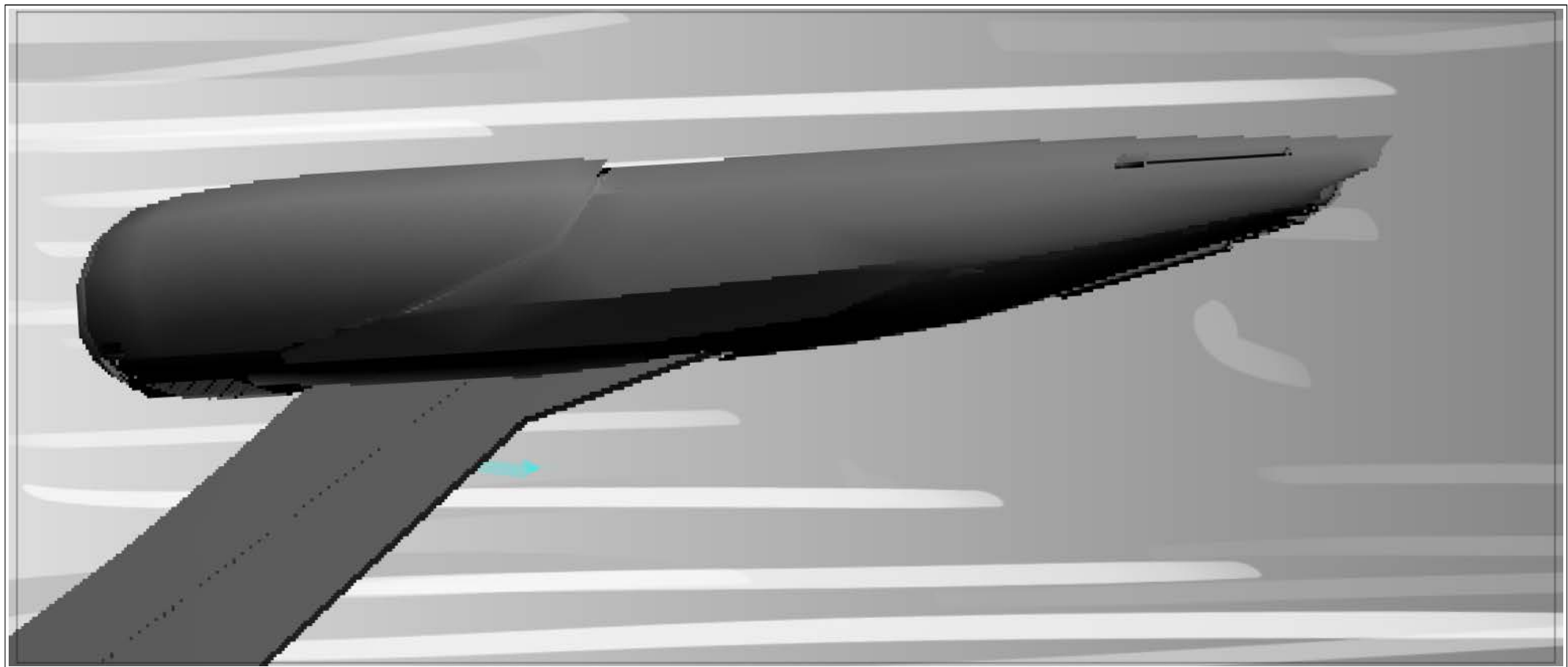

Scene	Duration	Panel	Duration
380	01:06	02B	00:03

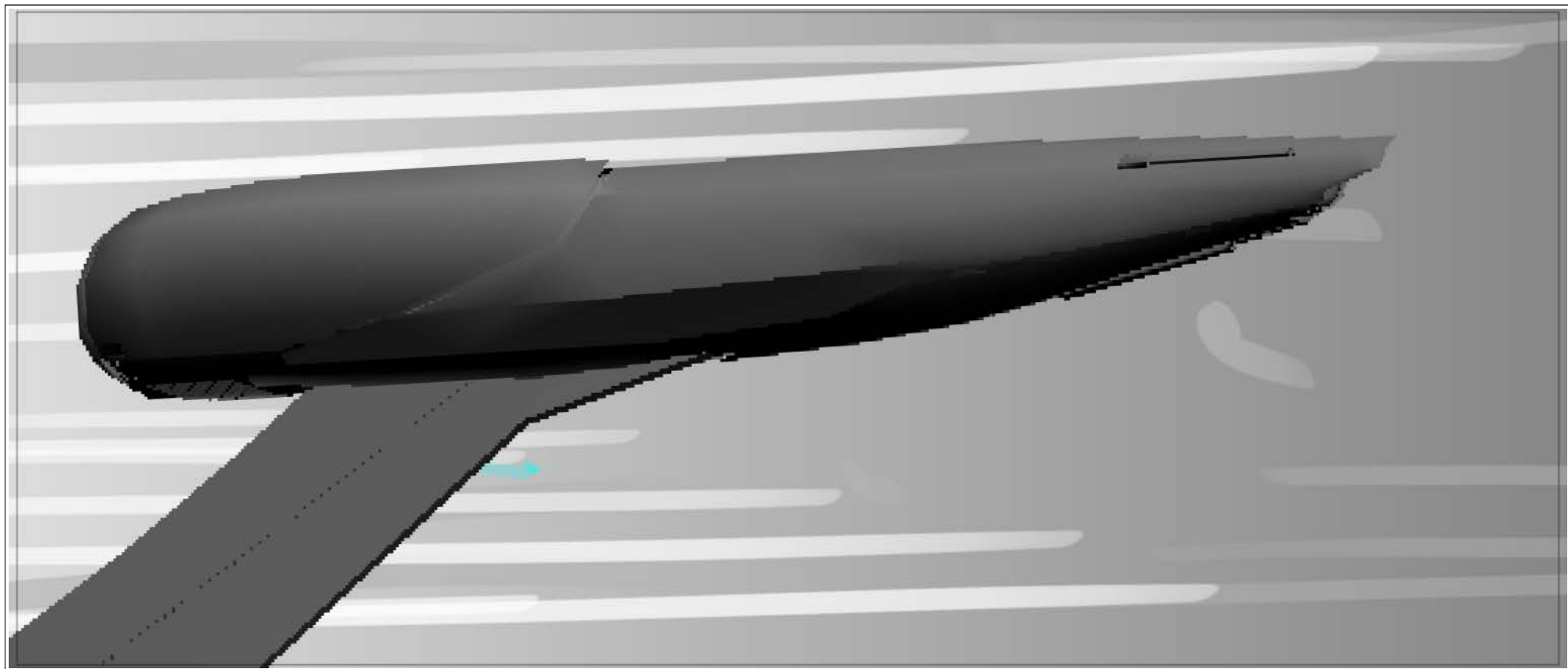

Scene	Duration	Panel	Duration
390	01:03	001	00:14

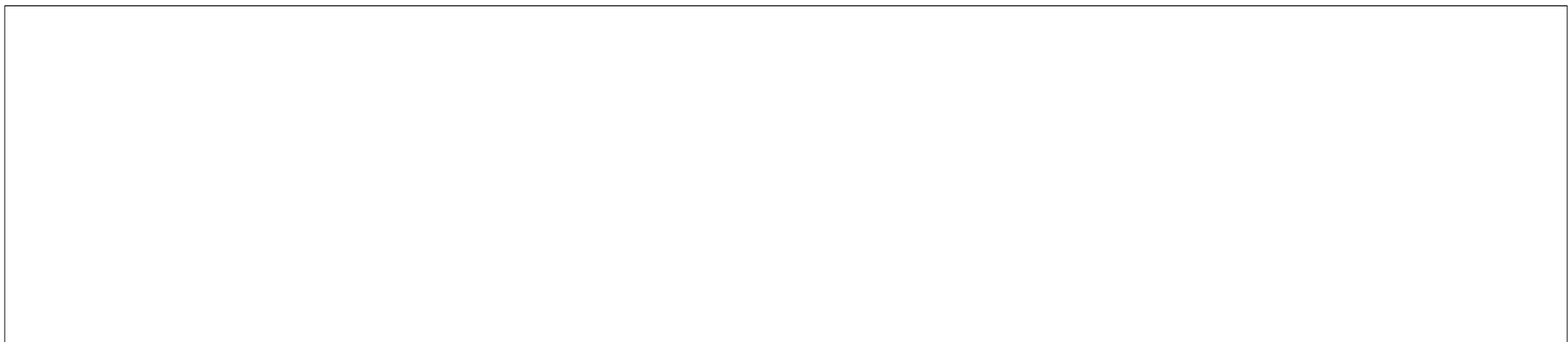
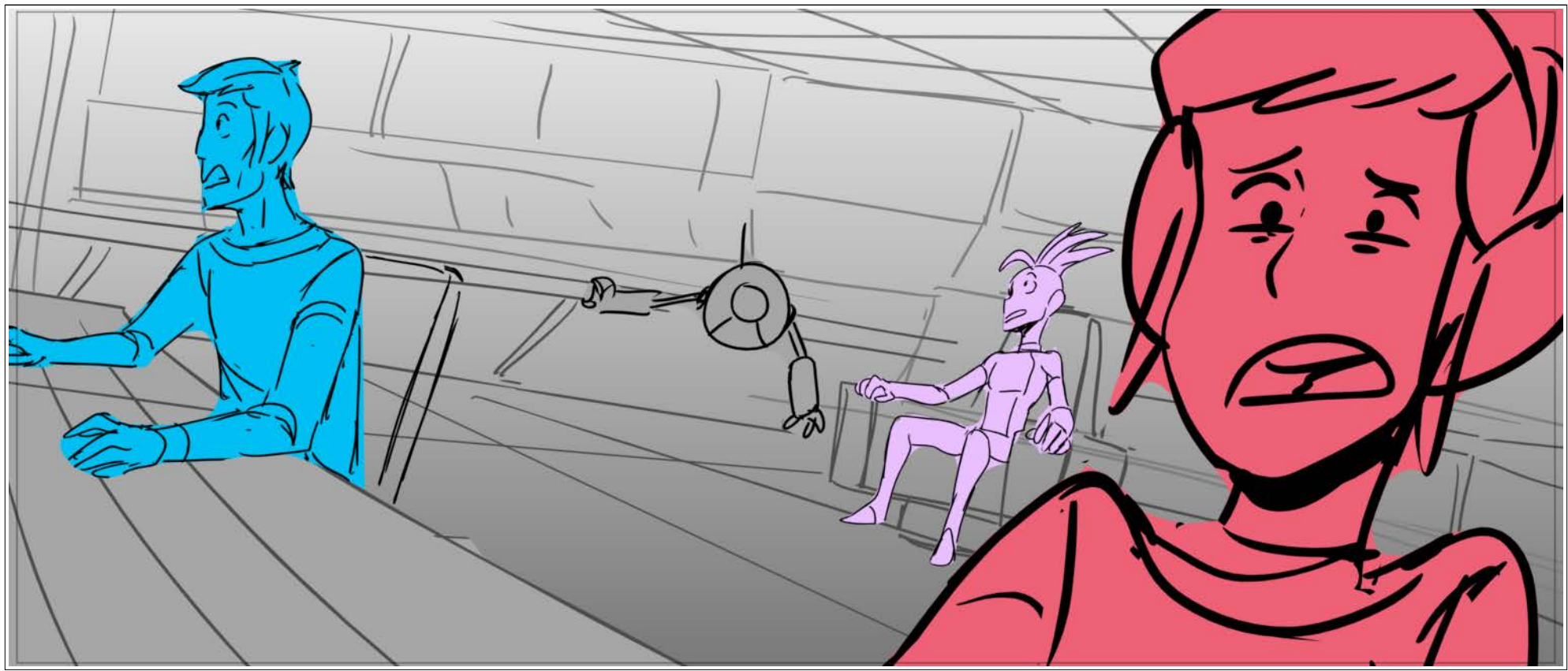

Scene	Duration	Panel	Duration
390	01:03	001A	00:13

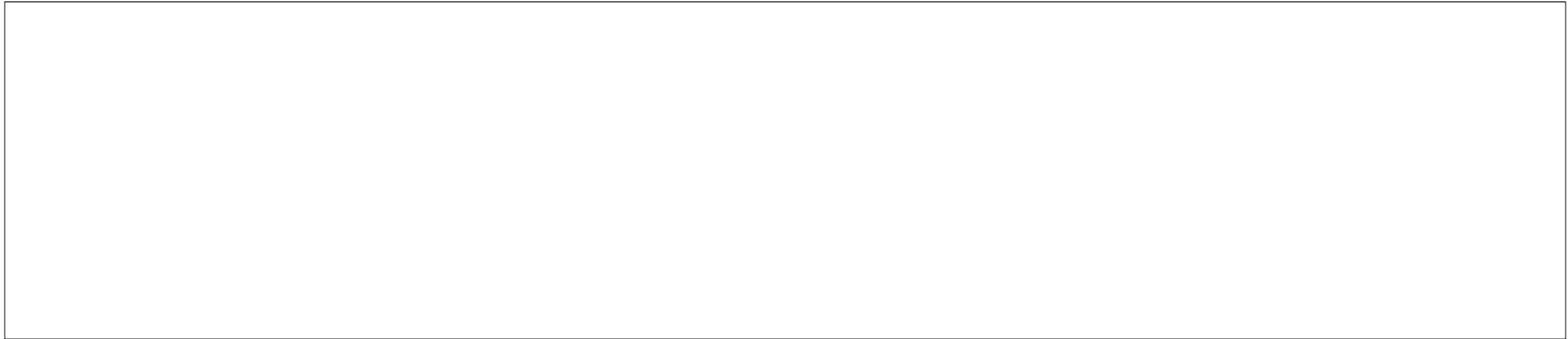
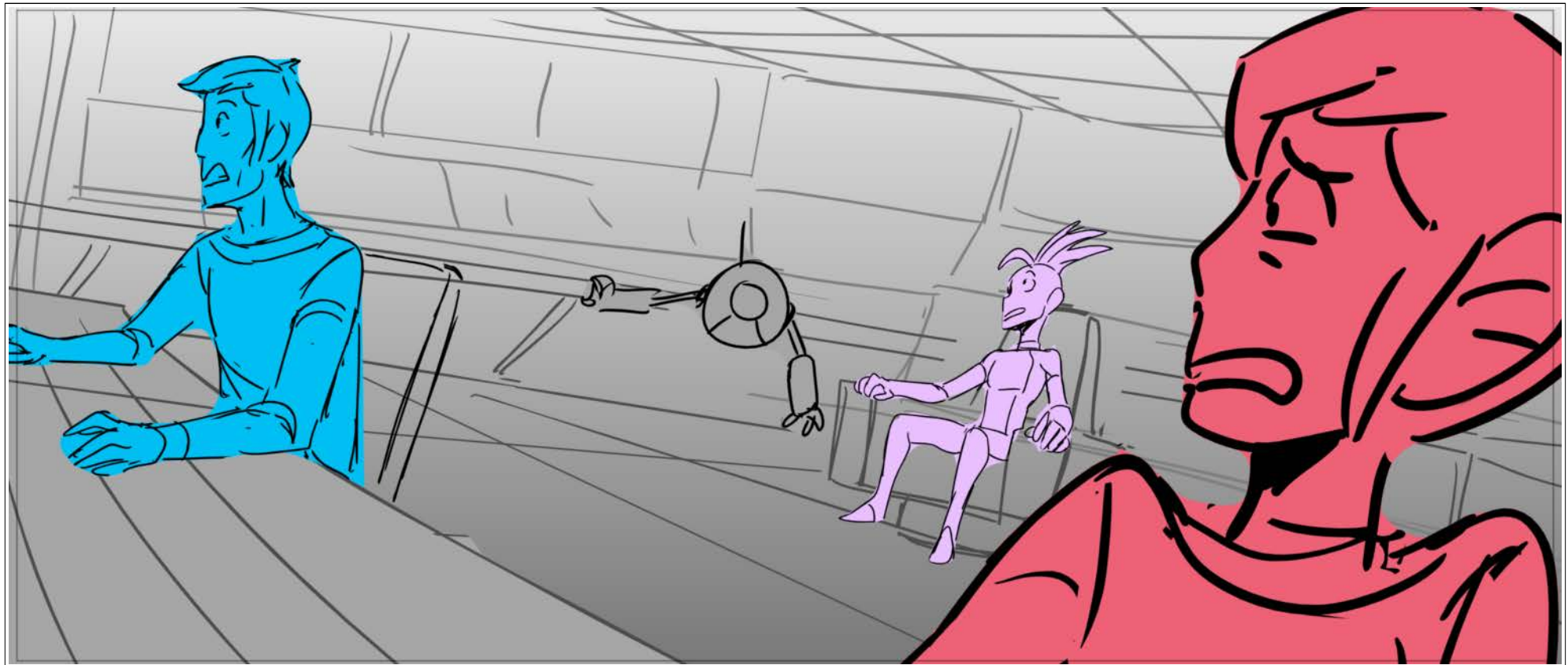

Scene	Duration	Panel	Duration
400	01:18	001	00:17

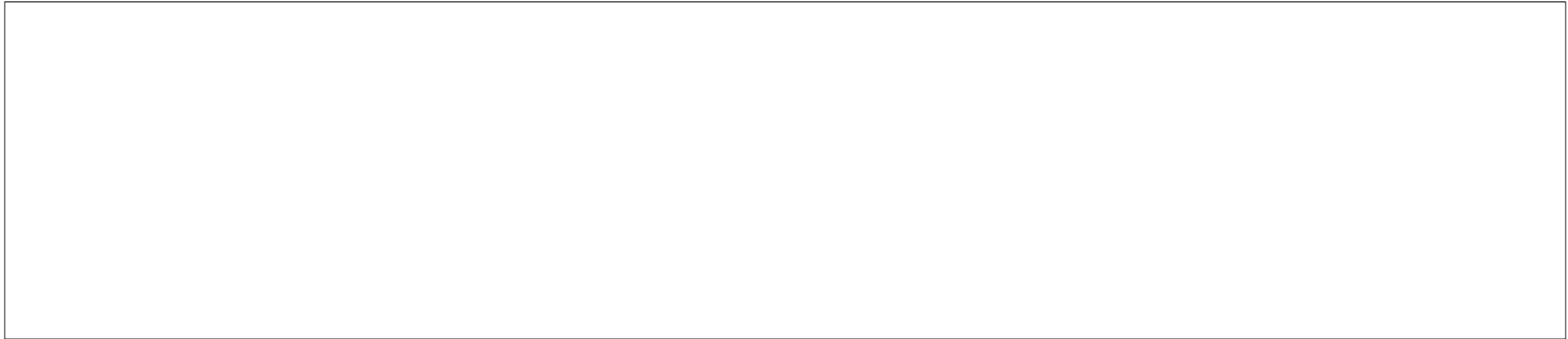

Scene	Duration	Panel	Duration
400	01:18	001A	00:15

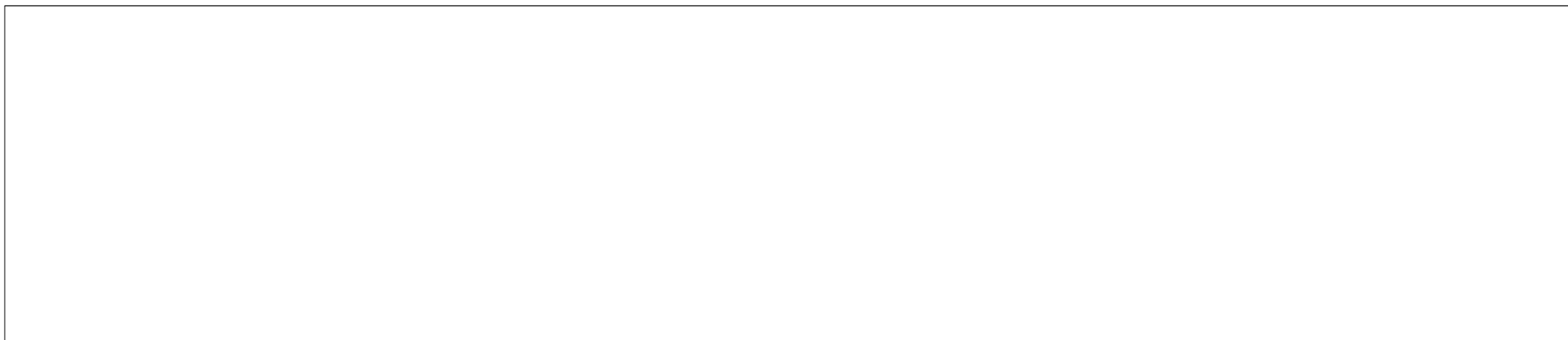
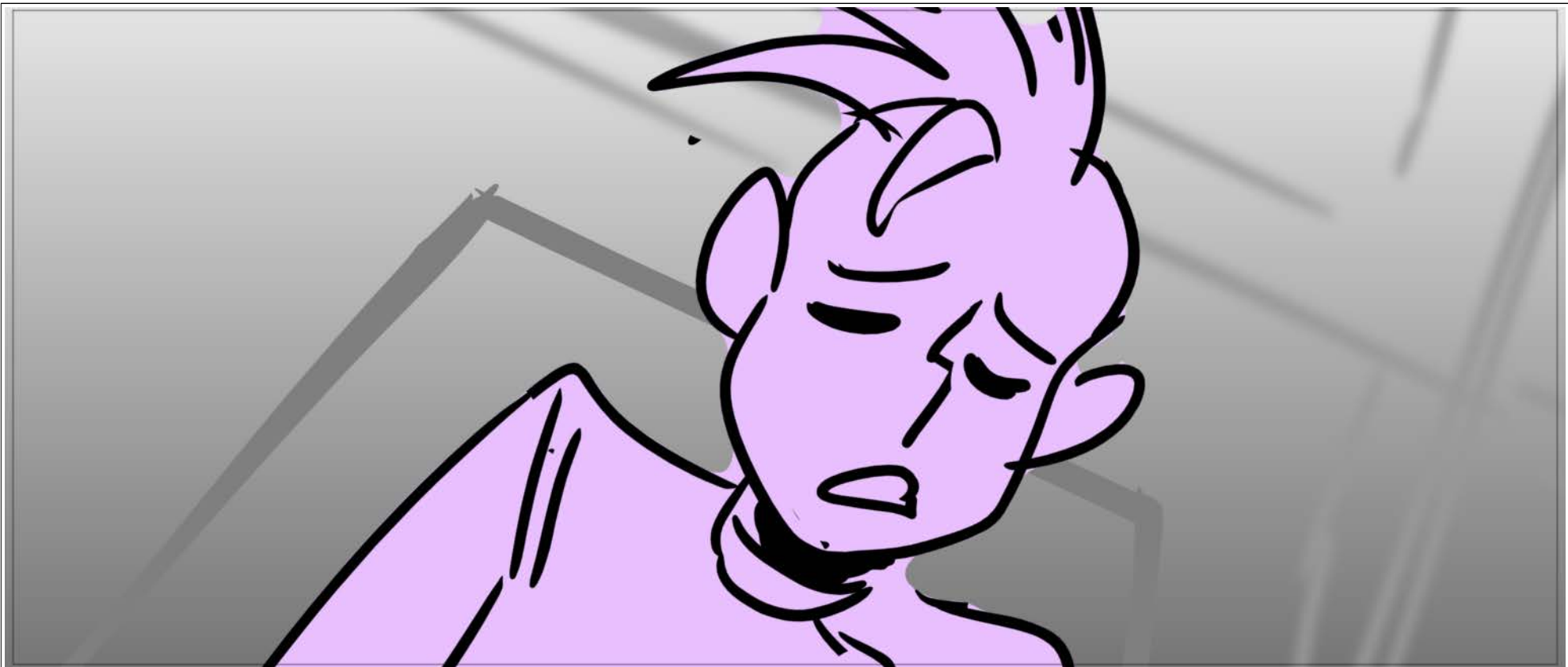

Scene	Duration	Panel	Duration
400	01:18	001B	00:10



Scene	Duration	Panel	Duration
410	01:00	001	01:00

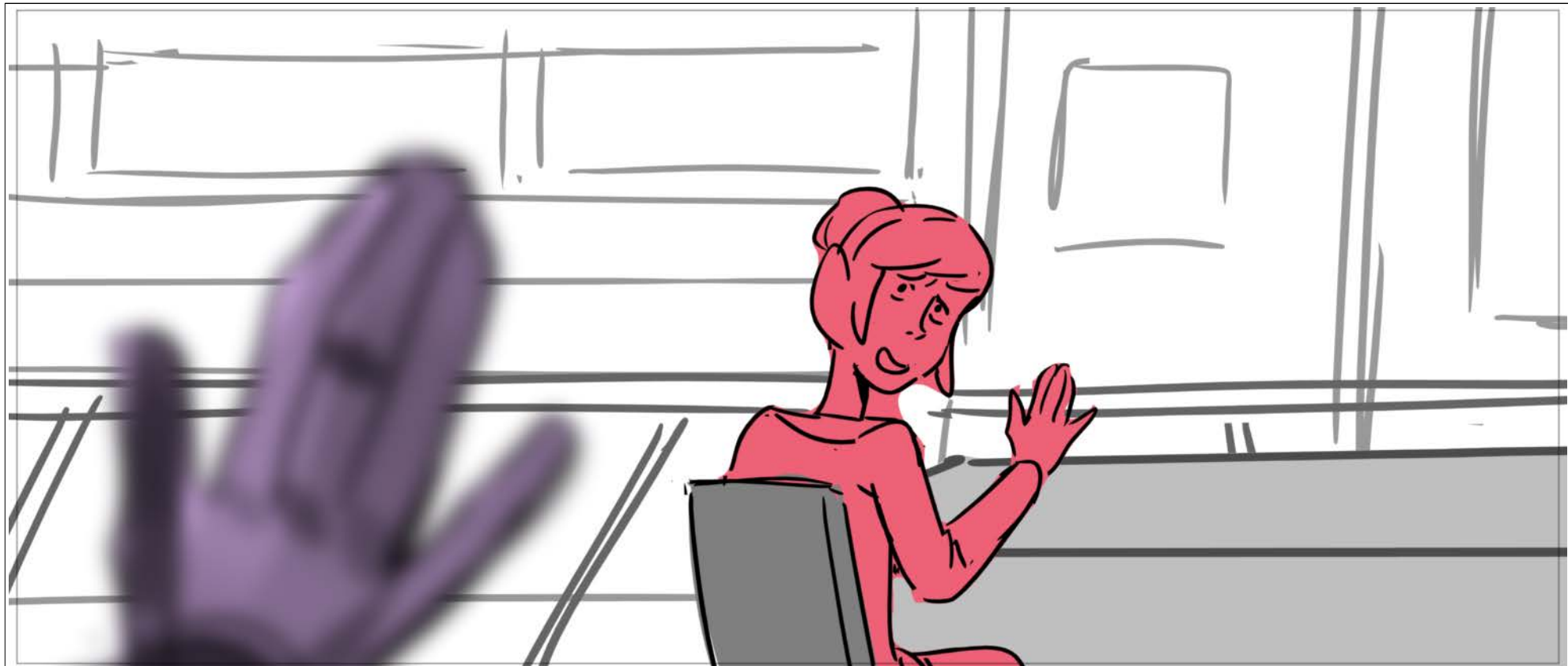

Scene	Duration	Panel	Duration
420	02:02	001	00:08

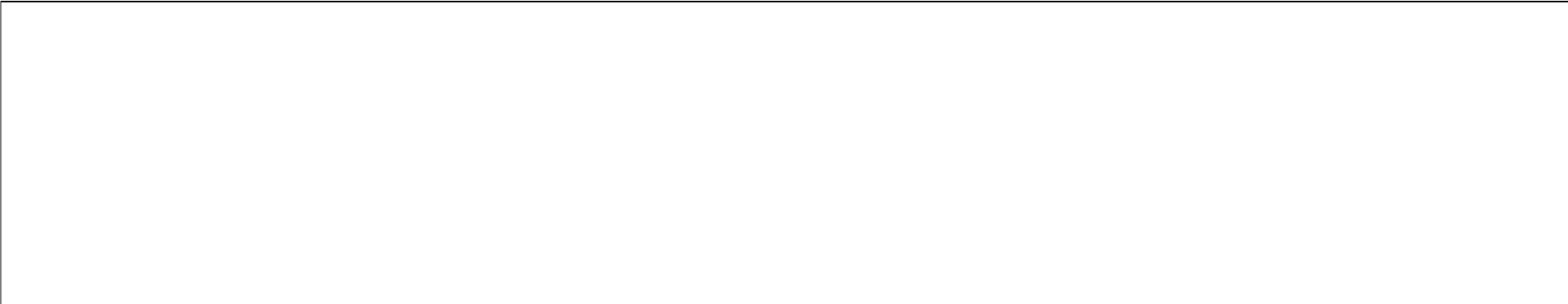
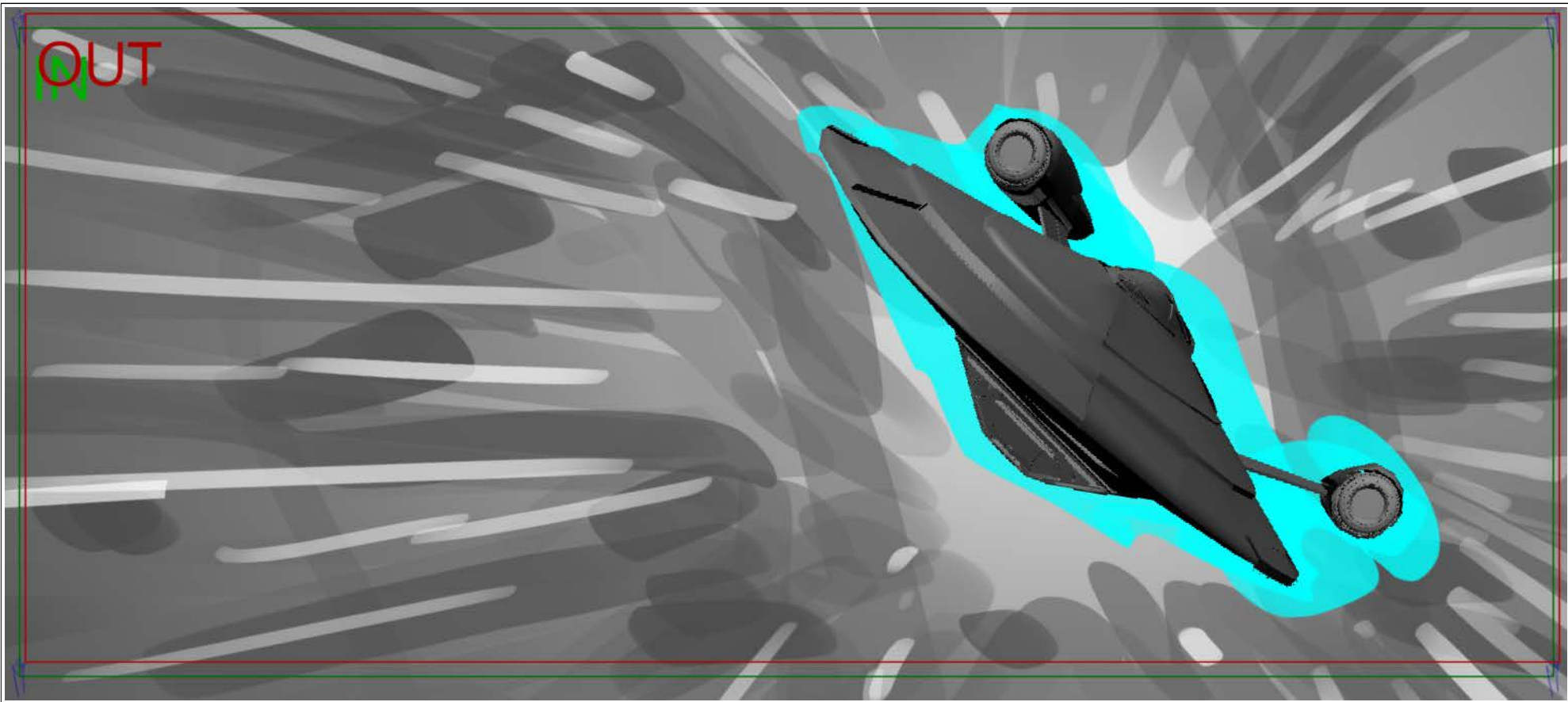

Scene	Duration	Panel	Duration
420	02:02	001A0	00:06

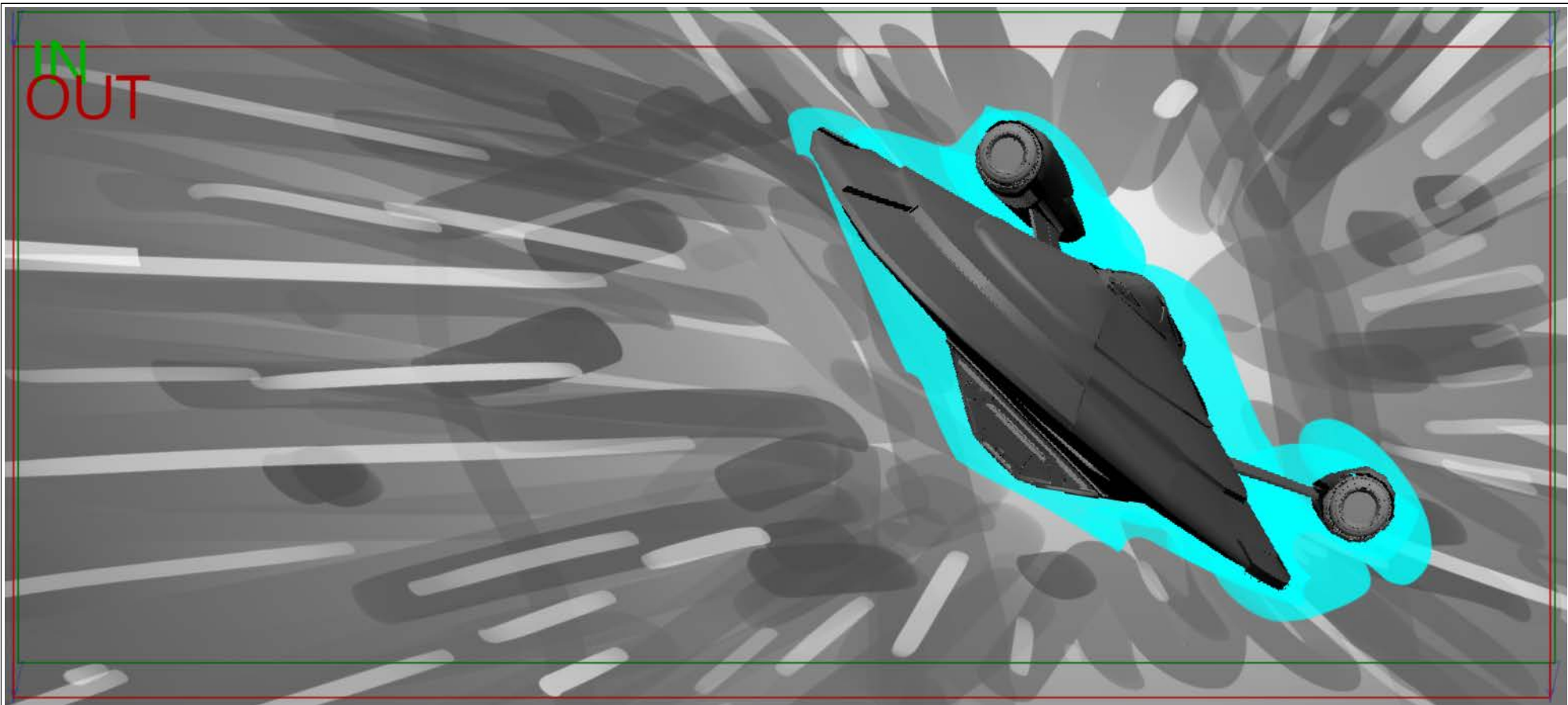

Scene	420	Duration	02:02	Panel	001A	Duration	00:04
-------	-----	----------	-------	-------	------	----------	-------

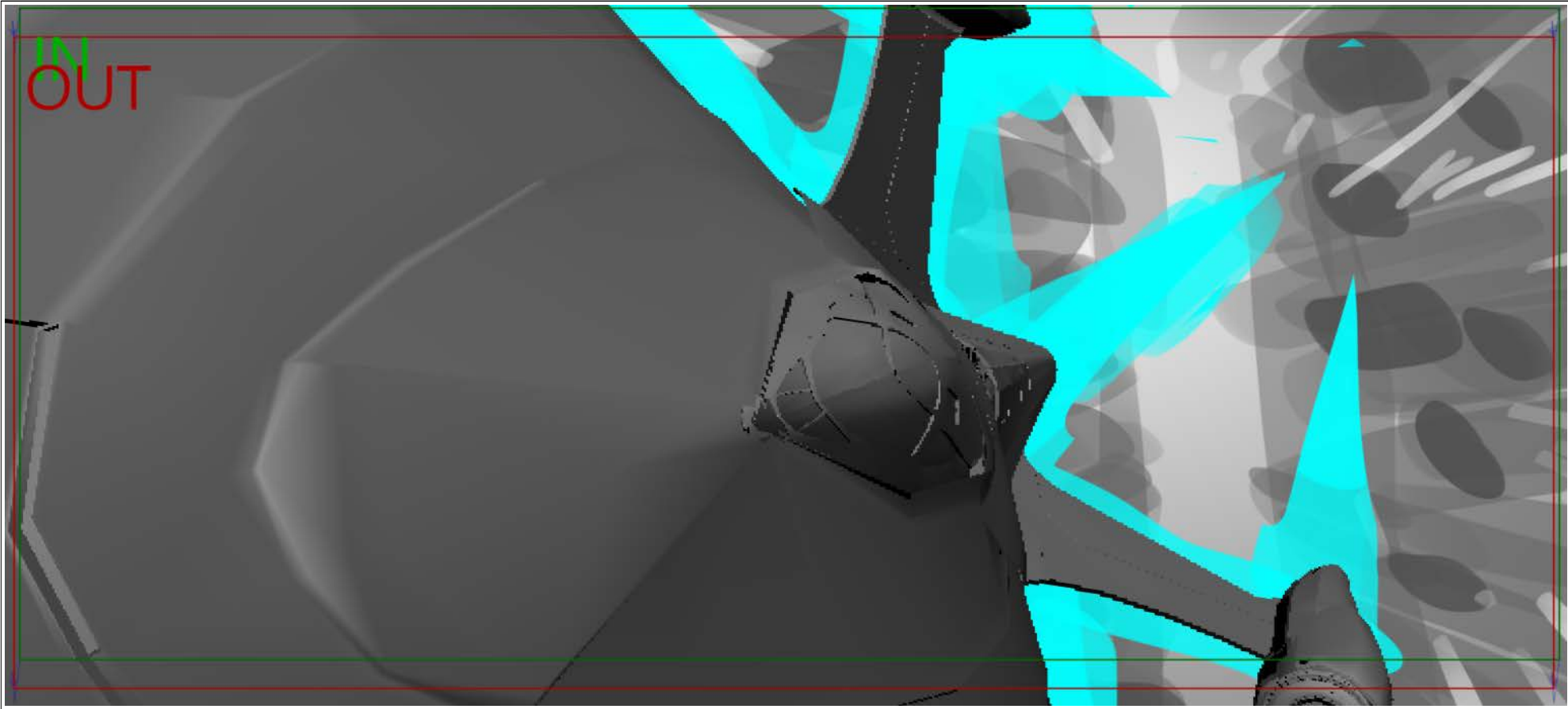

Scene	Duration	Panel	Duration
420	02:02	001D	00:06

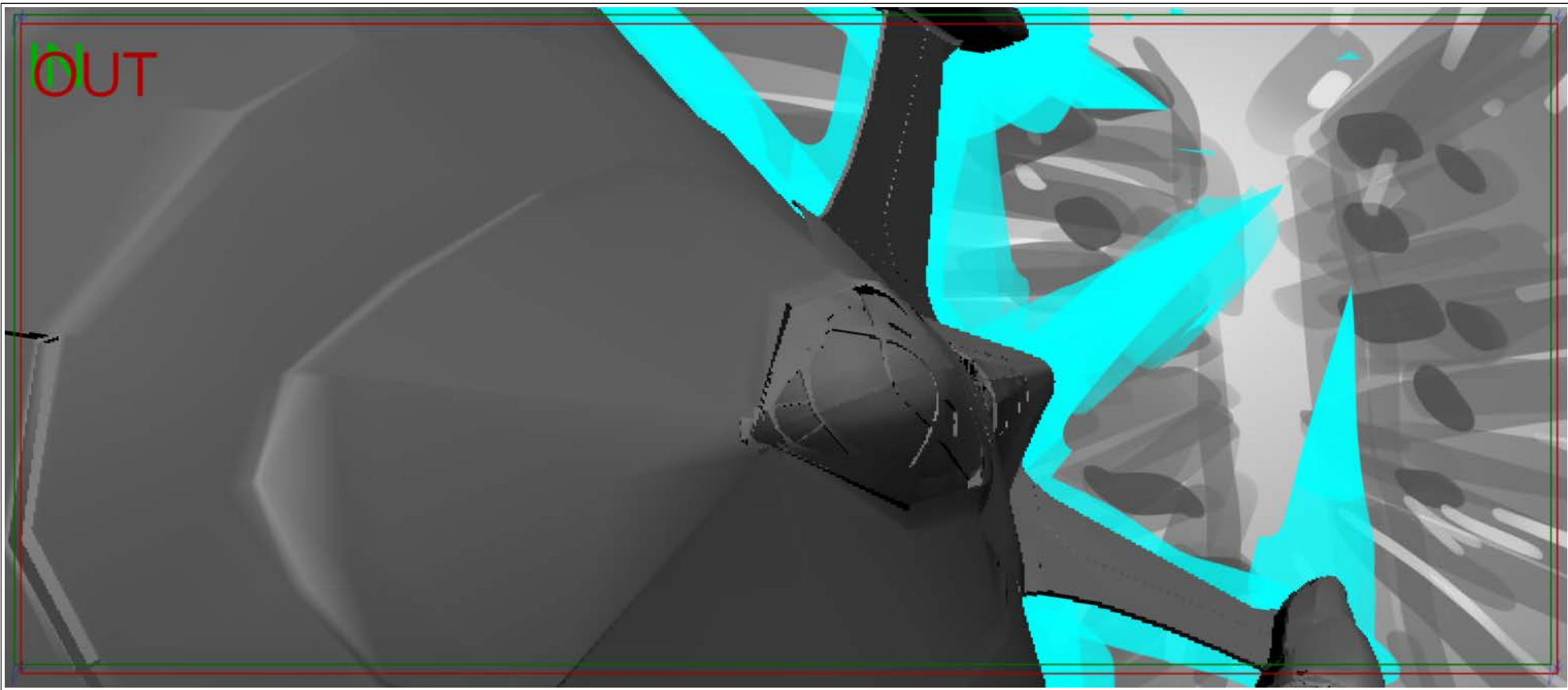

Scene	Duration	Panel	Duration
420	02:02	001B	00:08

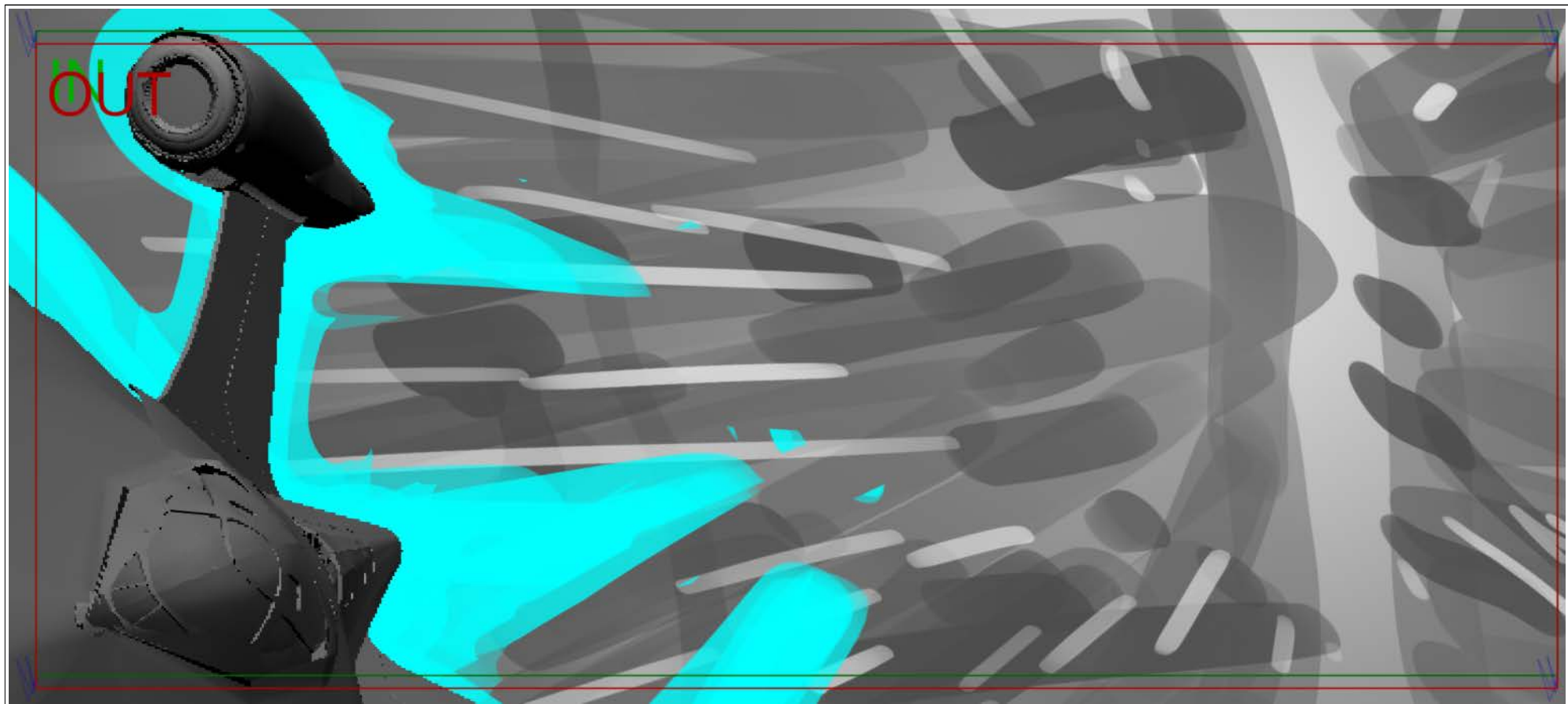

Scene	420	Duration	02:02	Panel	001E	Duration	00:06
-------	-----	----------	-------	-------	------	----------	-------

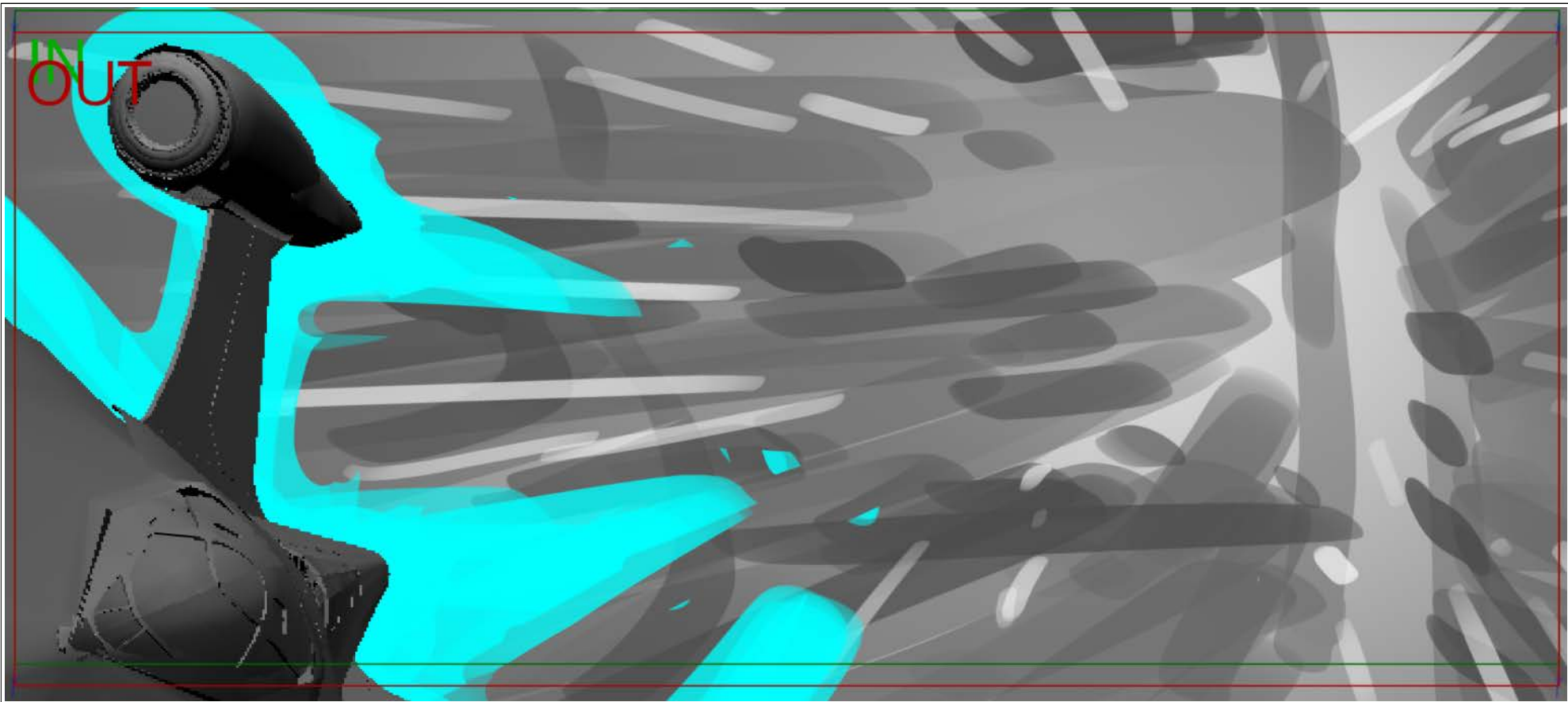

Scene	Duration	Panel	Duration
420	02:02	001C	00:06

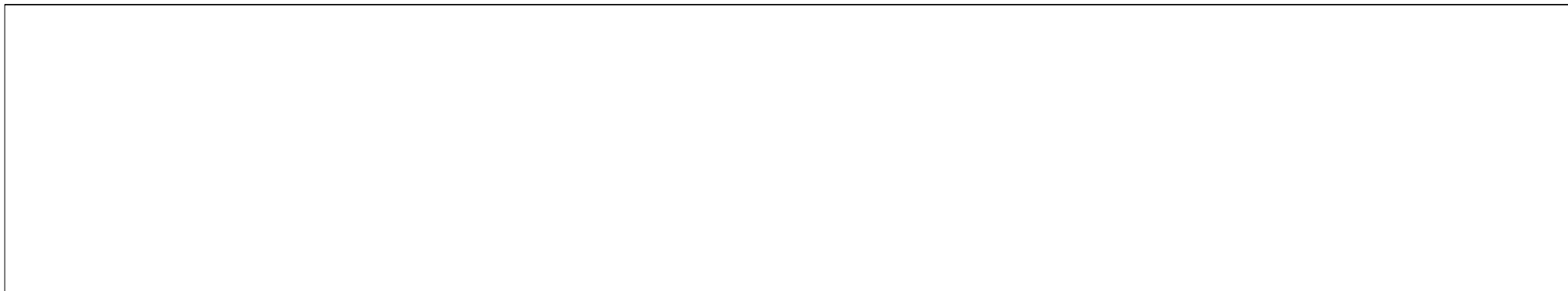
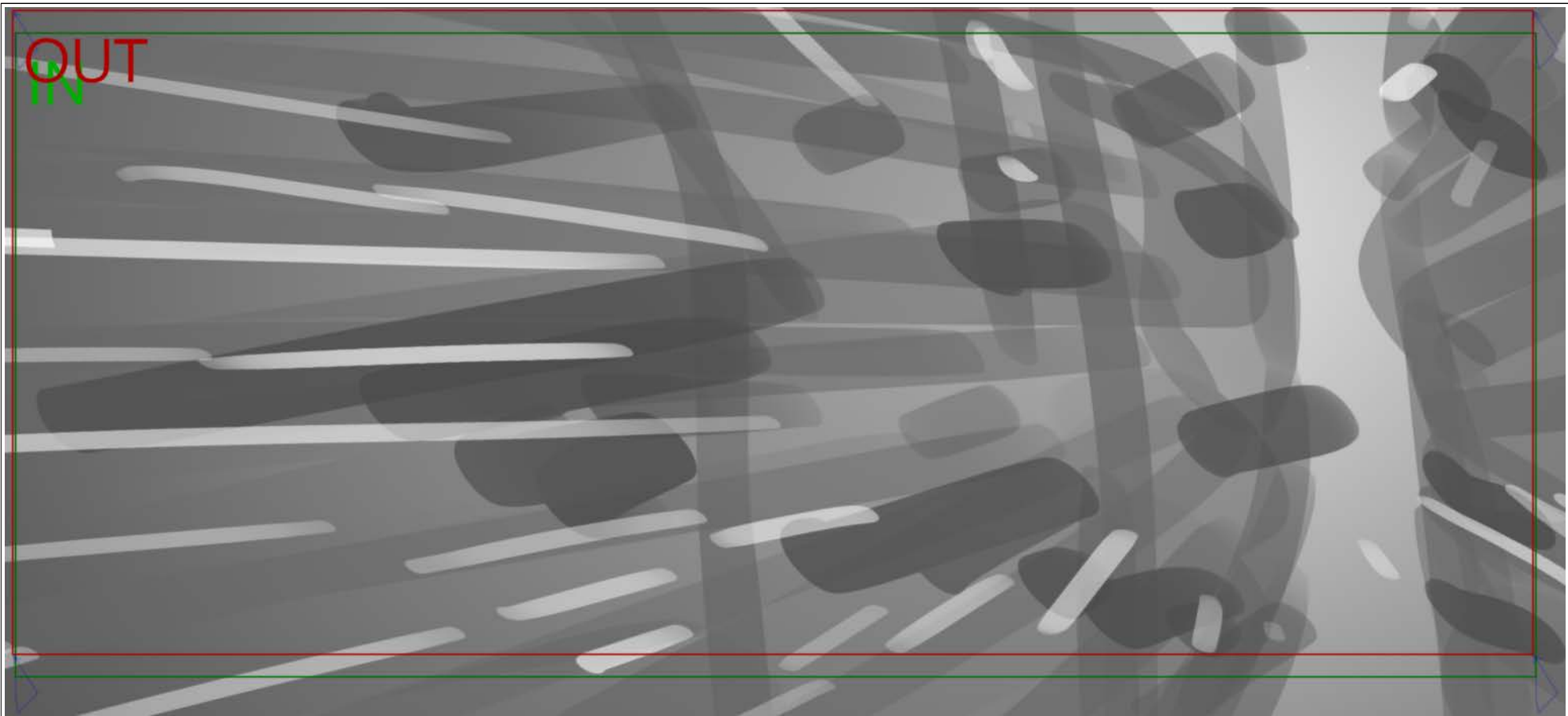

Scene	Duration	Panel	Duration
420	02:02	02C	00:06

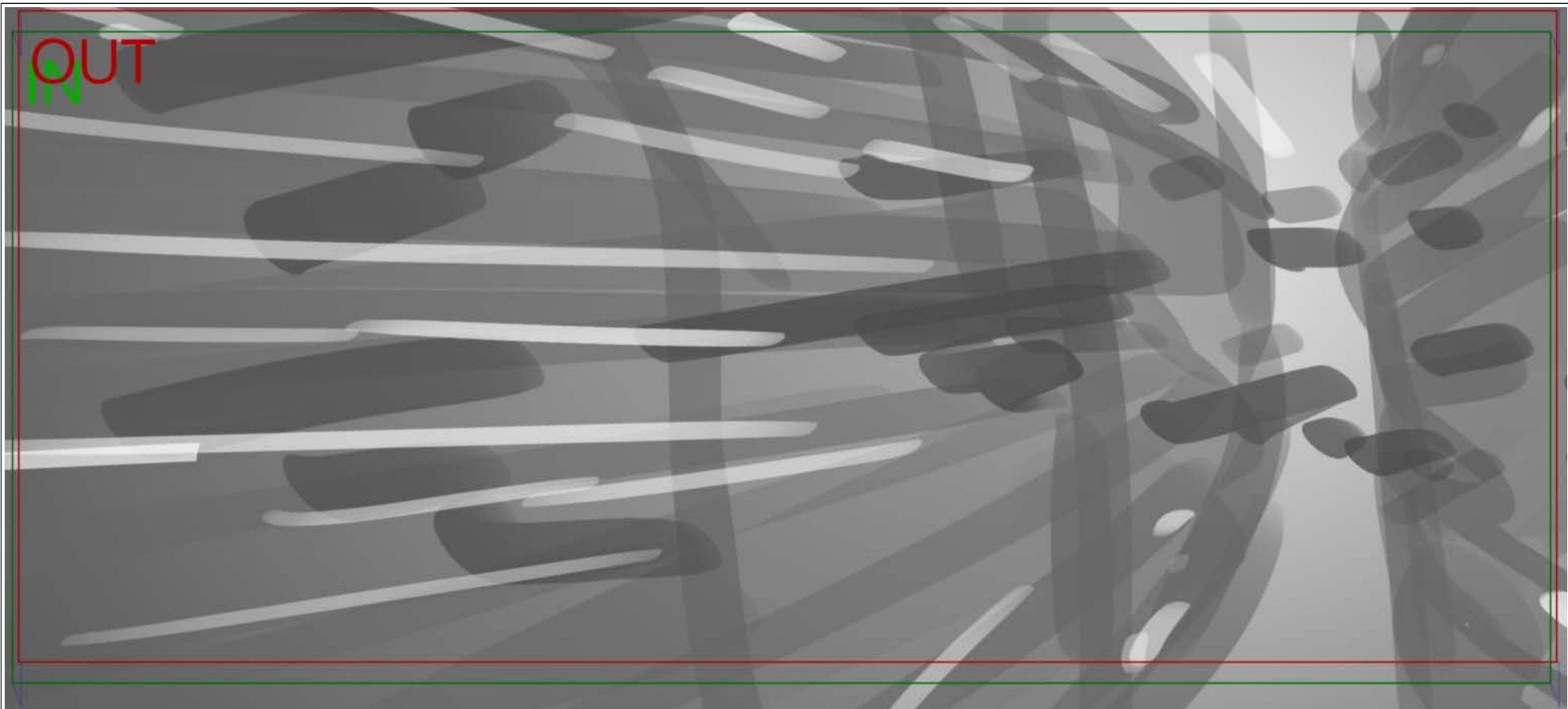

Scene	Duration	Panel	Duration
430	02:00	001	00:12

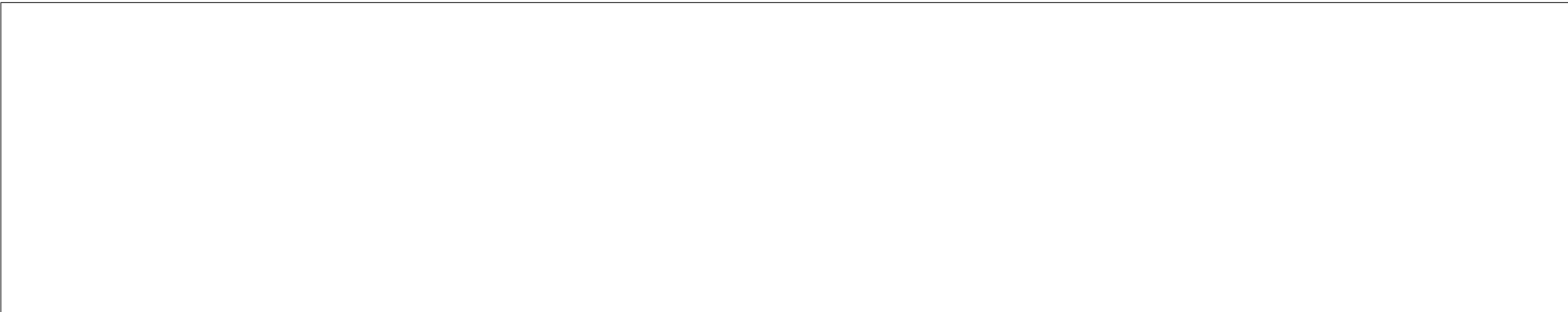

Scene	Duration	Panel	Duration
430	02:00	001A0	00:12

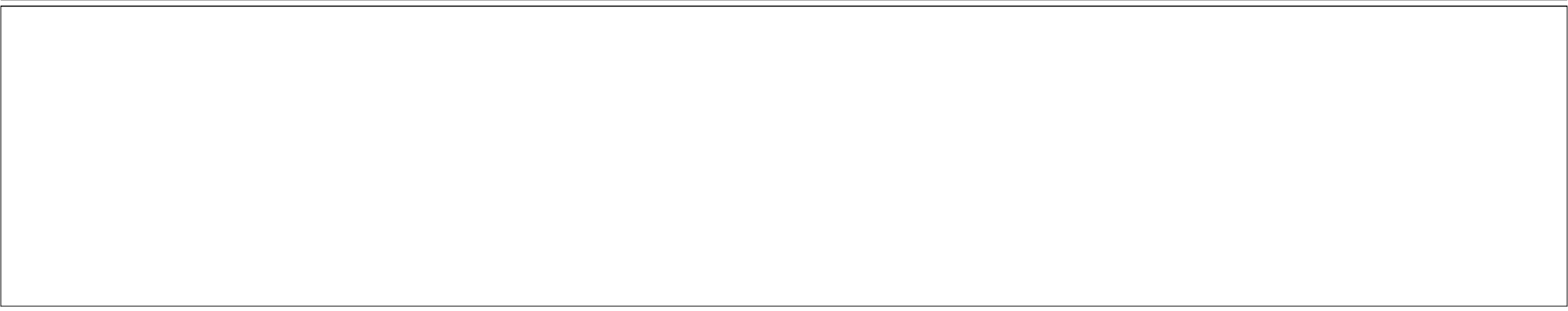

Scene	Duration	Panel	Duration
430	02:00	001A	00:13



Action Notes
CAMERA SHAKE

Scene	Duration	Panel	Duration
430	02:00	02A	00:11



Action Notes
CAMERA SHAKE

Scene	Duration	Panel	Duration
440	01:14	001	00:11

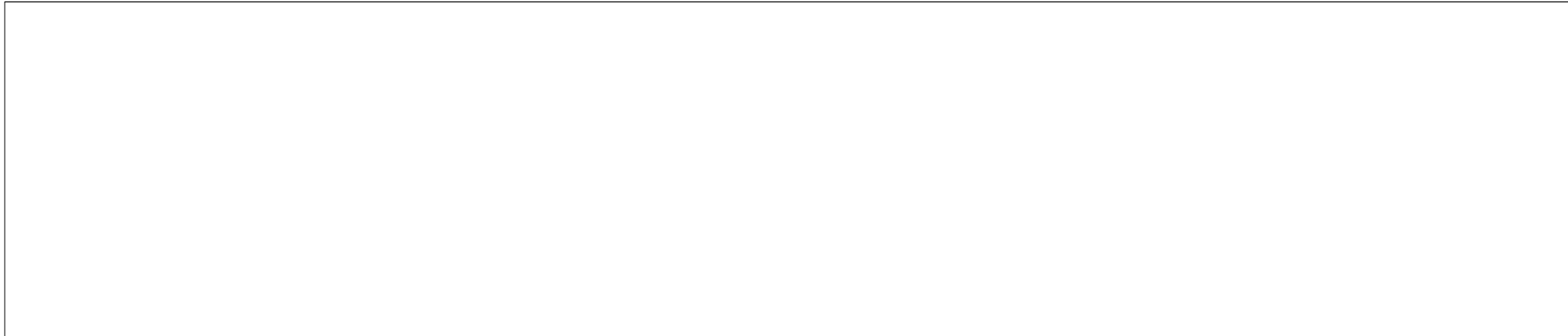
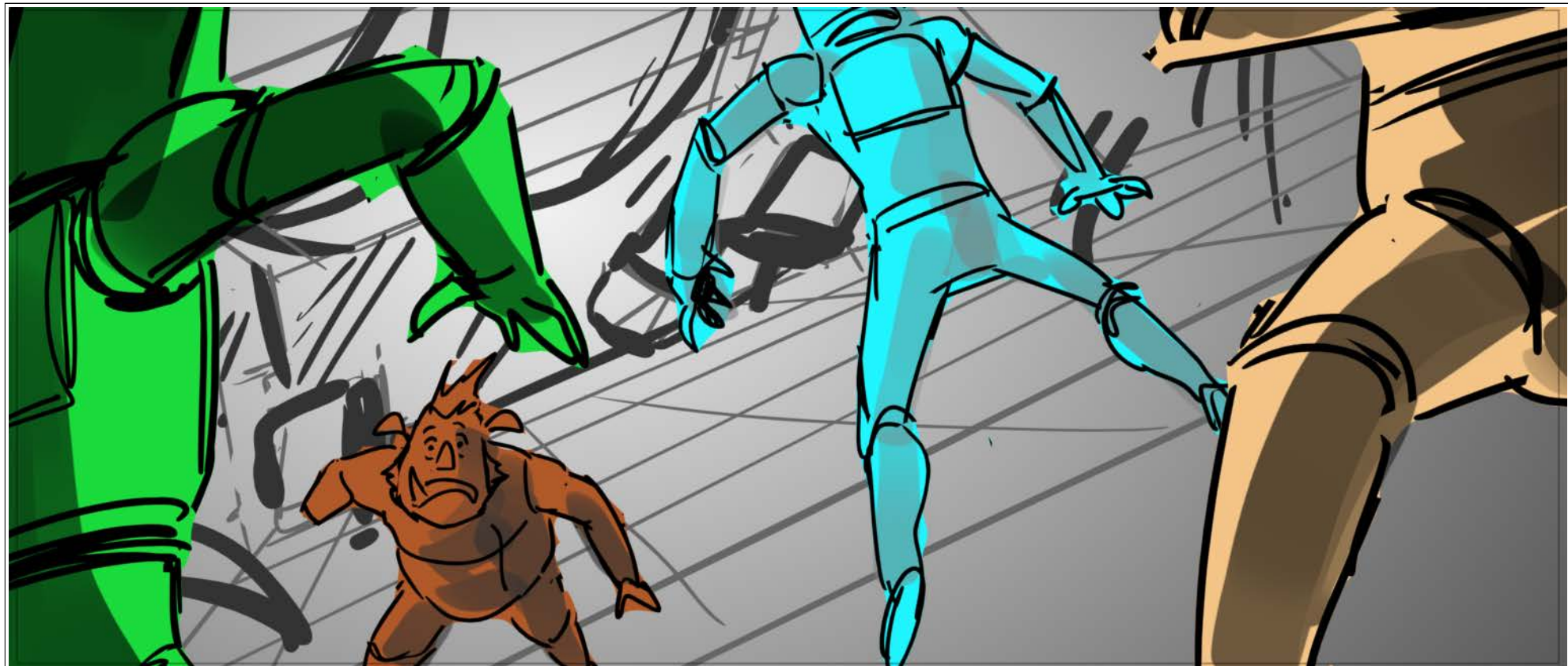

Scene	Duration	Panel	Duration
440	01:14	001A	00:09

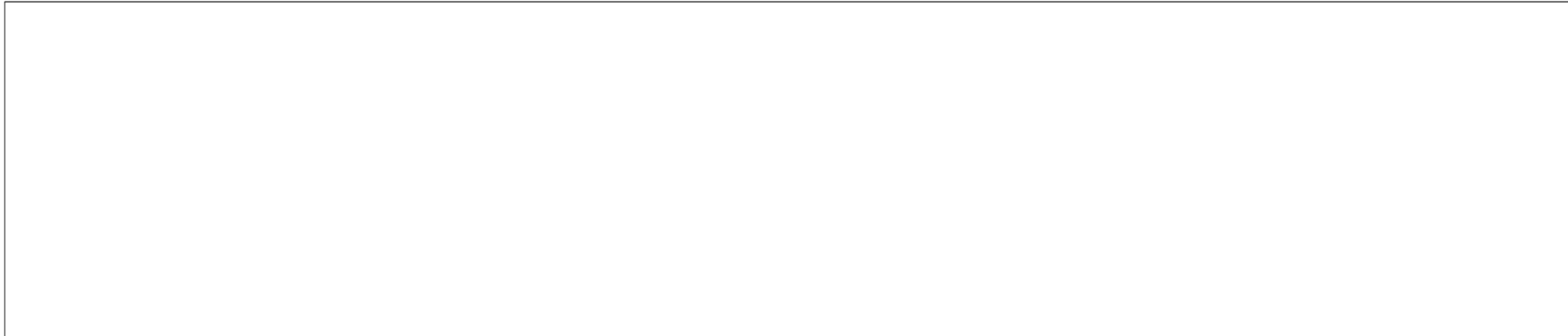
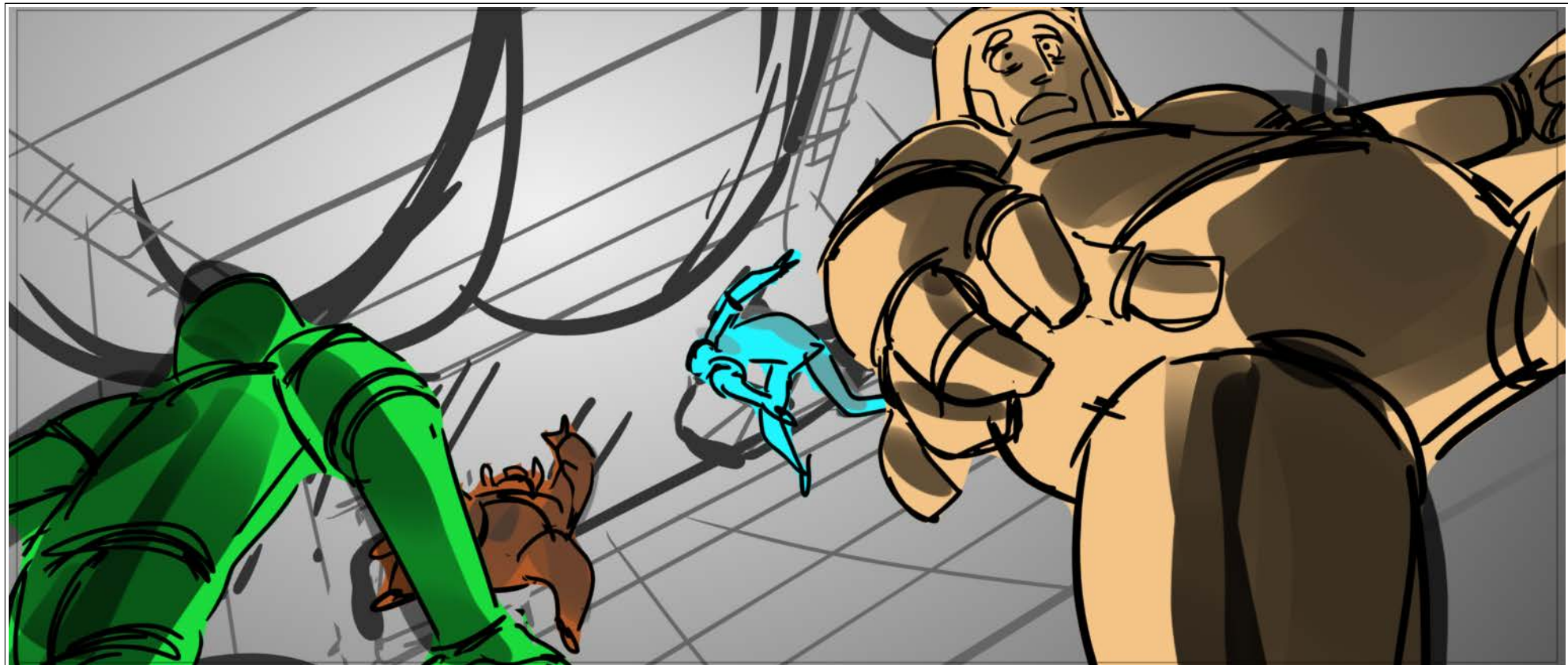

Scene	Duration	Panel	Duration
440	01:14	001C	00:08

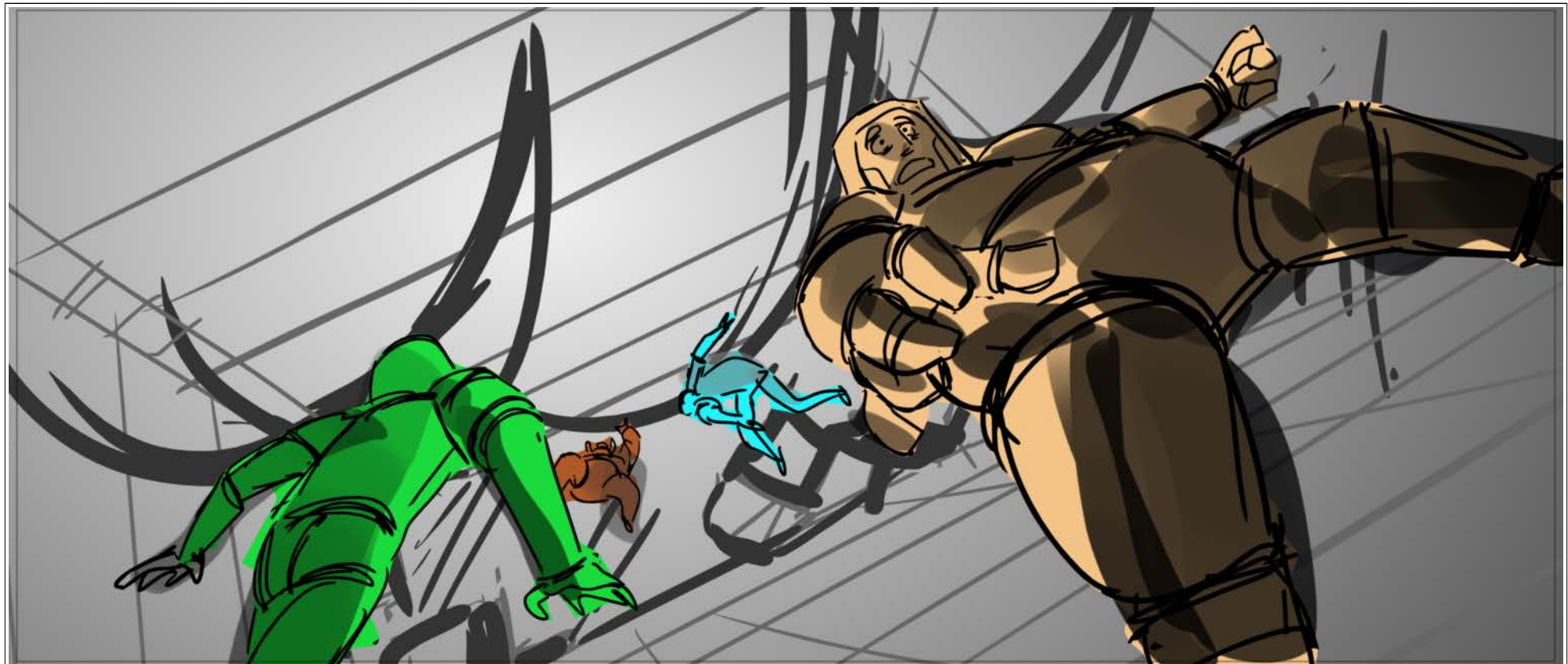

Scene	Duration	Panel	Duration
440	01:14	001B	00:10

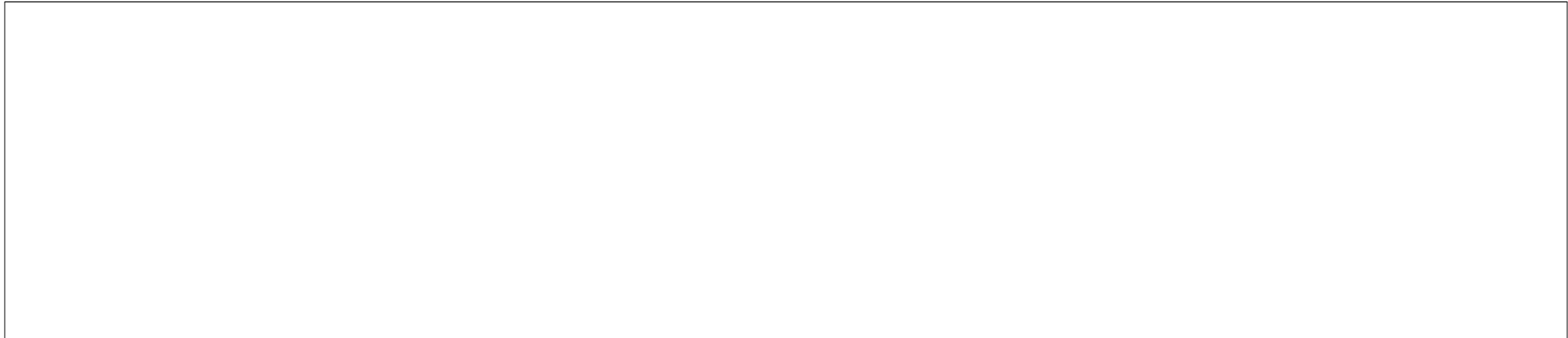
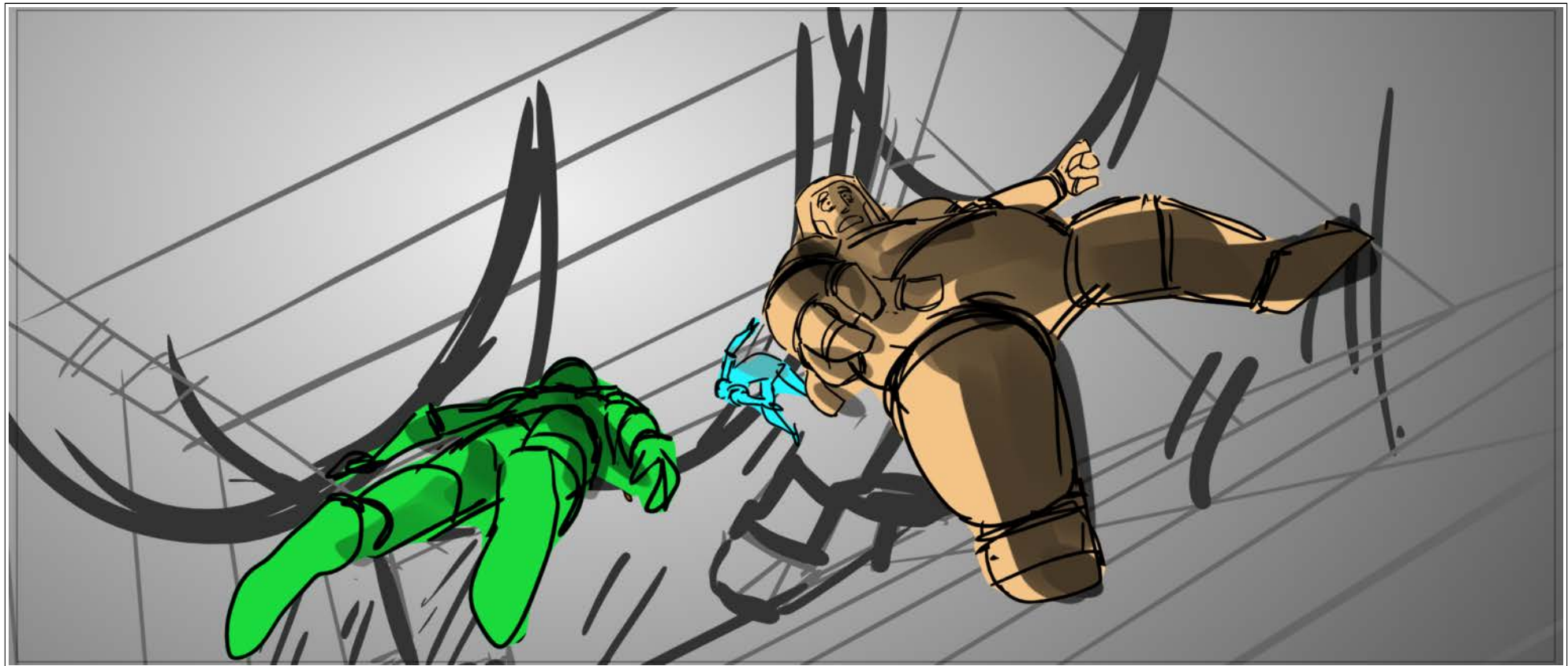

Scene	Duration	Panel	Duration
450	00:20	001	00:10

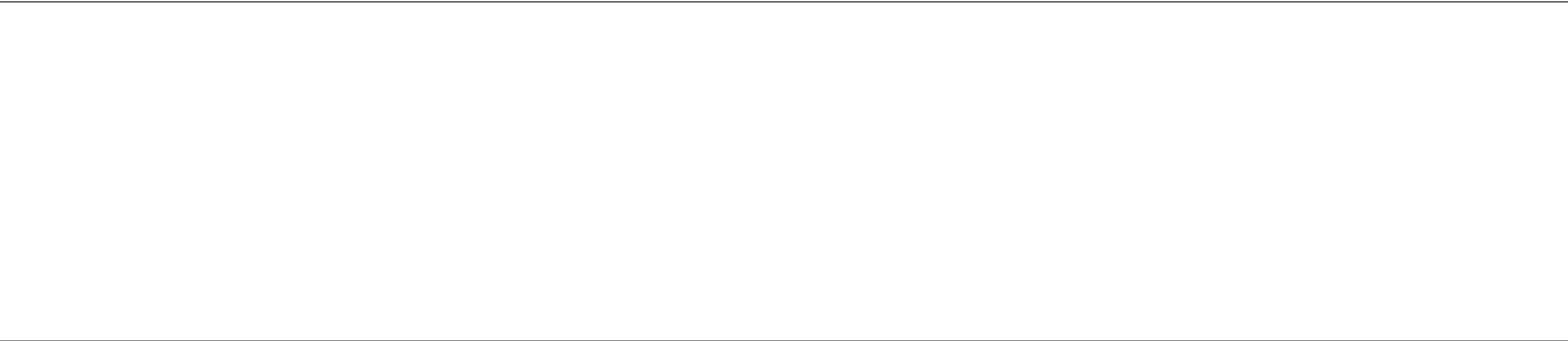
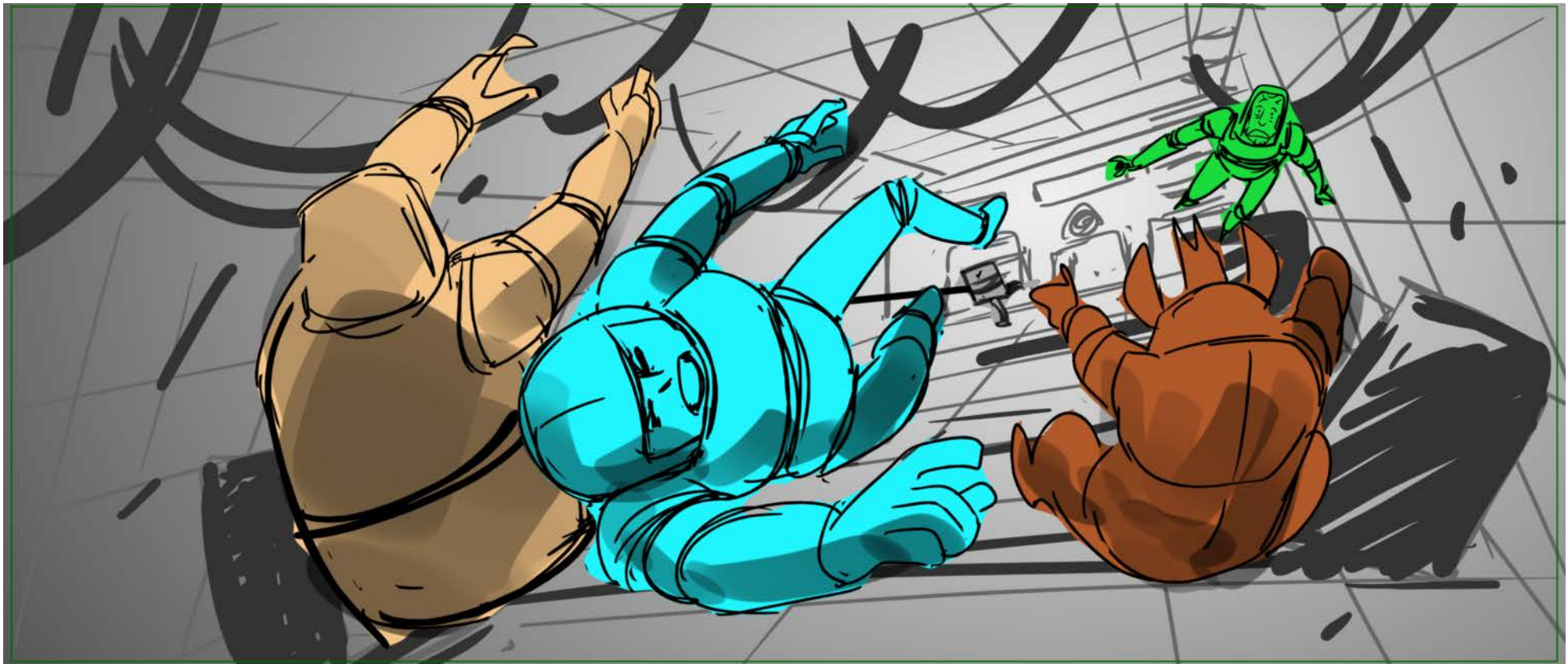

Scene	Duration	Panel	Duration
450	00:20	001A	00:02

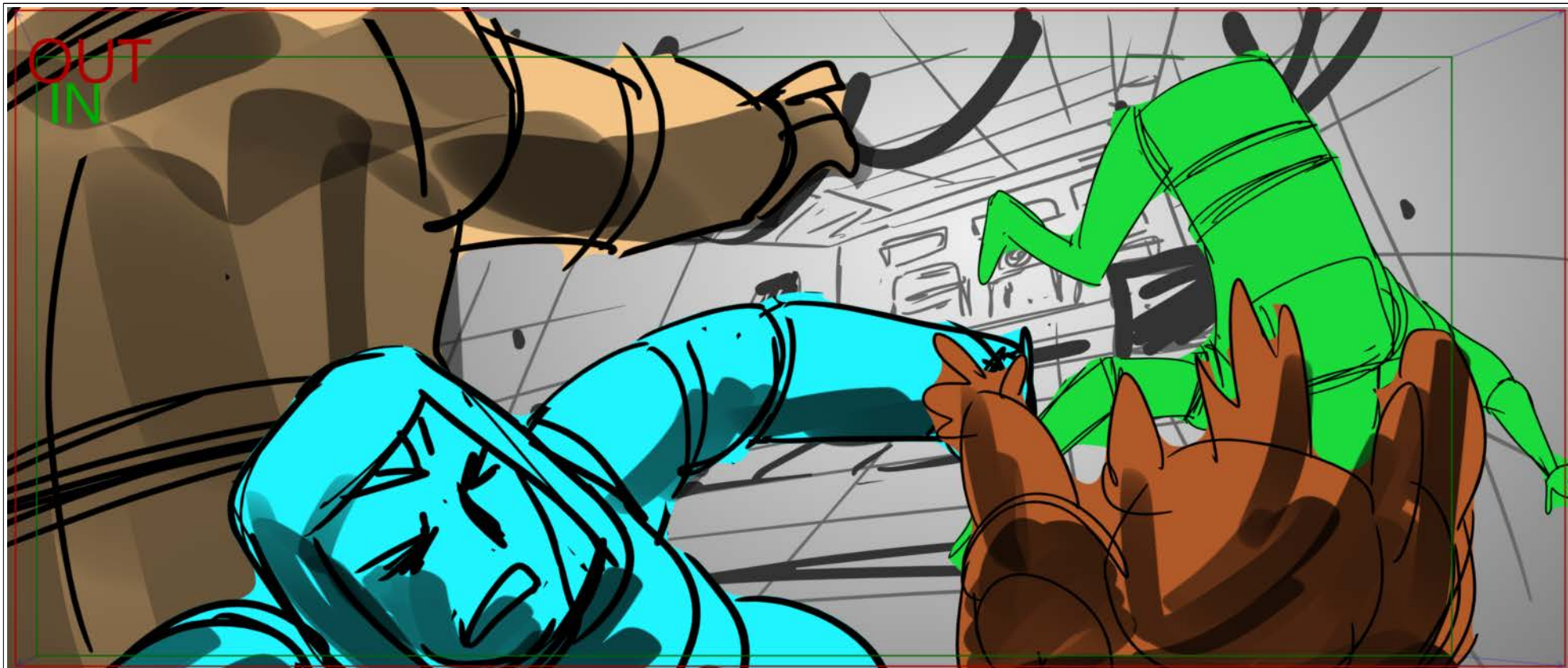

Action Notes
CAMERA SHAKE

Scene	Duration	Panel	Duration
450	00:20	001B	00:02



Action Notes
CAMERA SHAKE

Scene	Duration	Panel	Duration
450	00:20	02A	00:06



Action Notes
CAMERA SHAKE

Scene	Duration	Panel	Duration
455	00:20	001	00:05

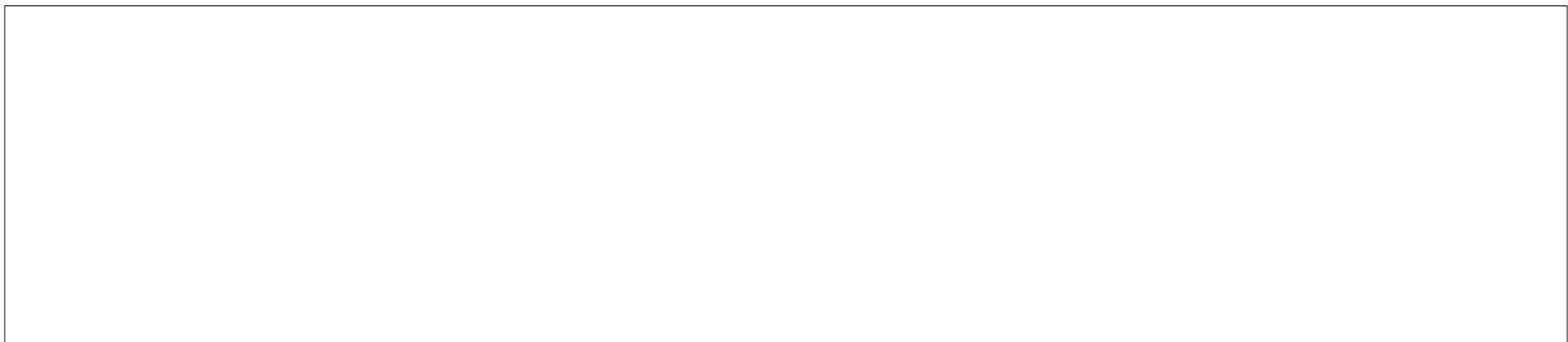
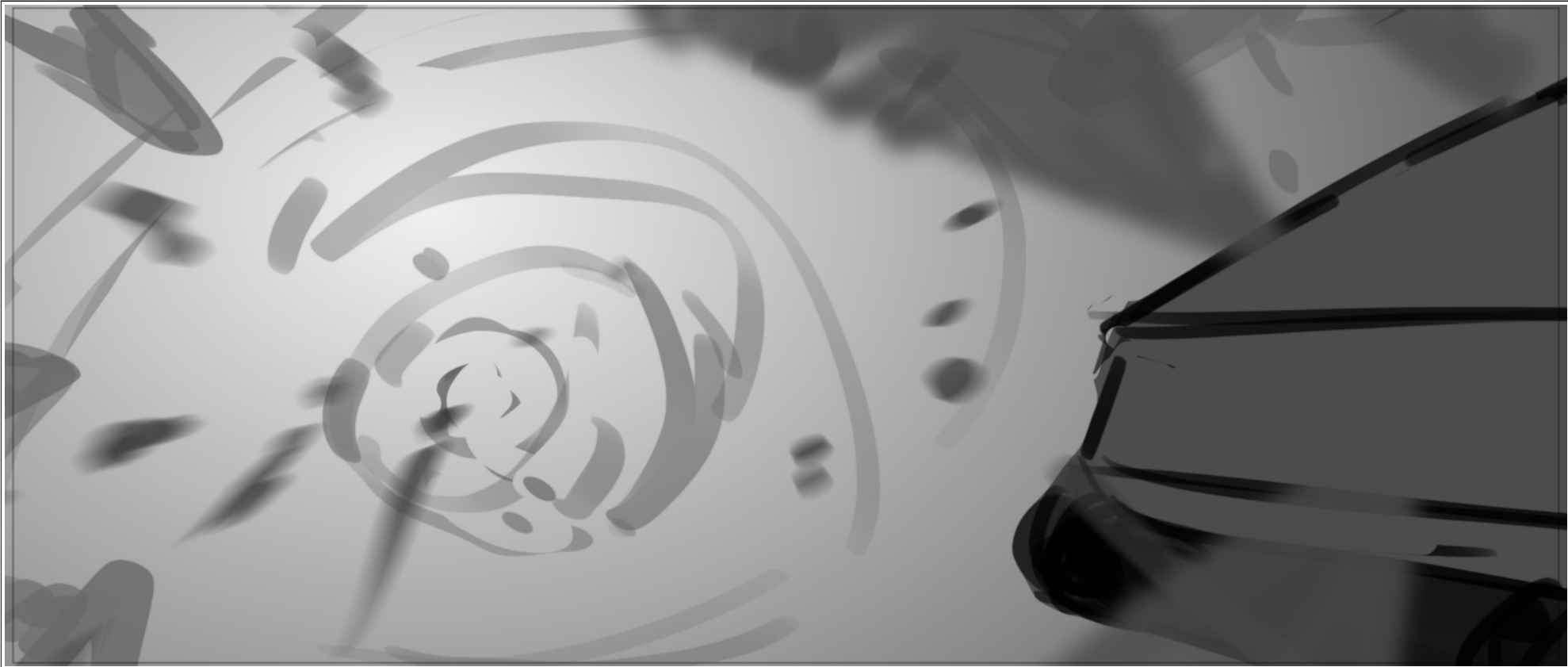

Scene	Duration	Panel	Duration
455	00:20	002	00:04

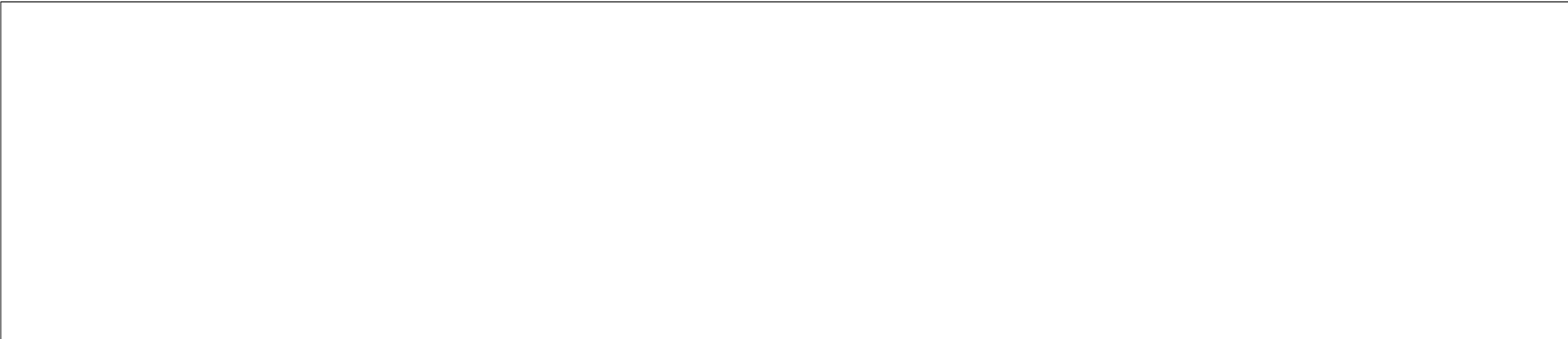
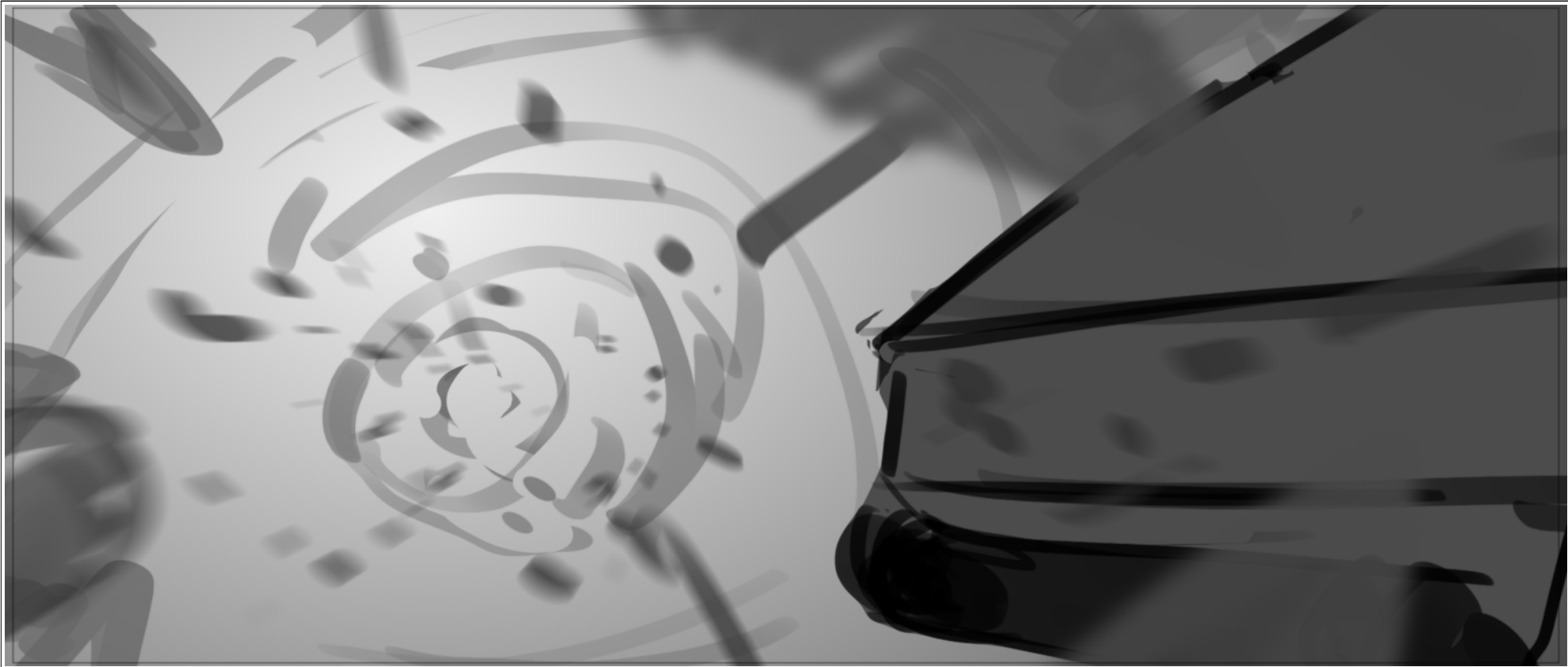

Scene	Duration	Panel	Duration
455	00:20	003	00:04

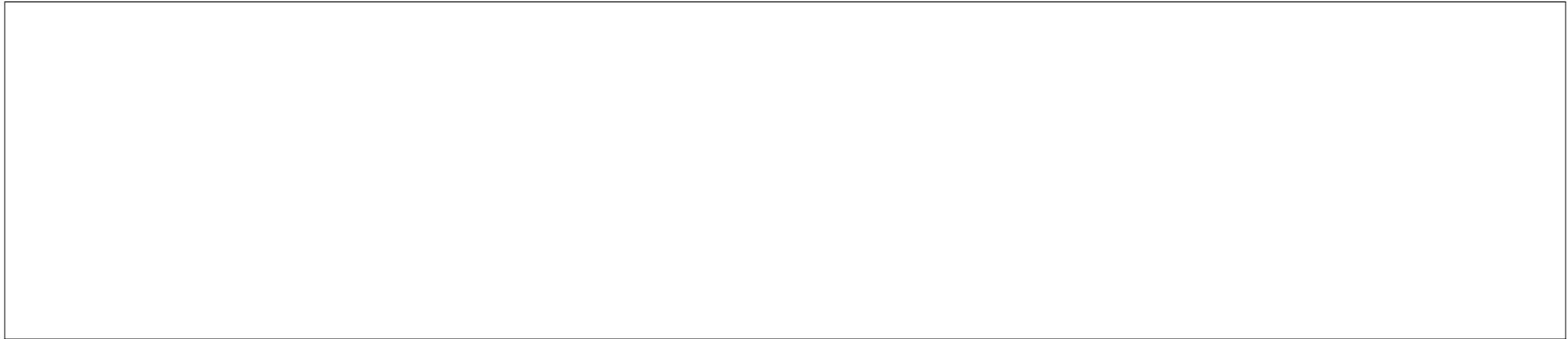
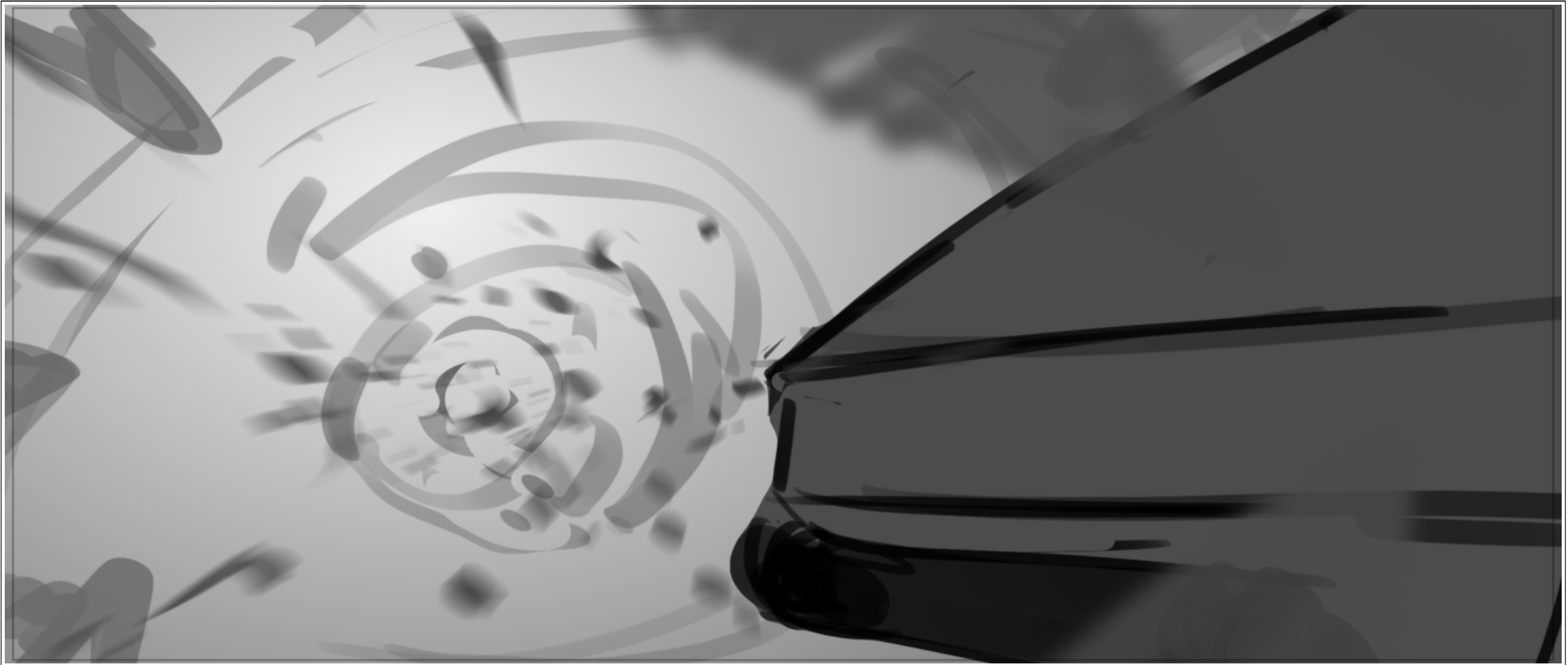

Scene	Duration	Panel	Duration
455	00:20	003A	00:02

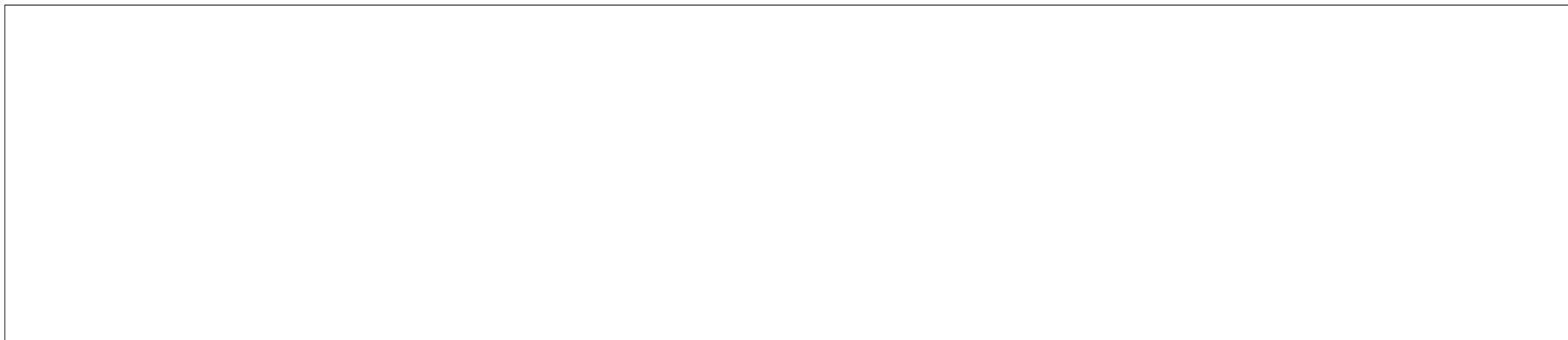
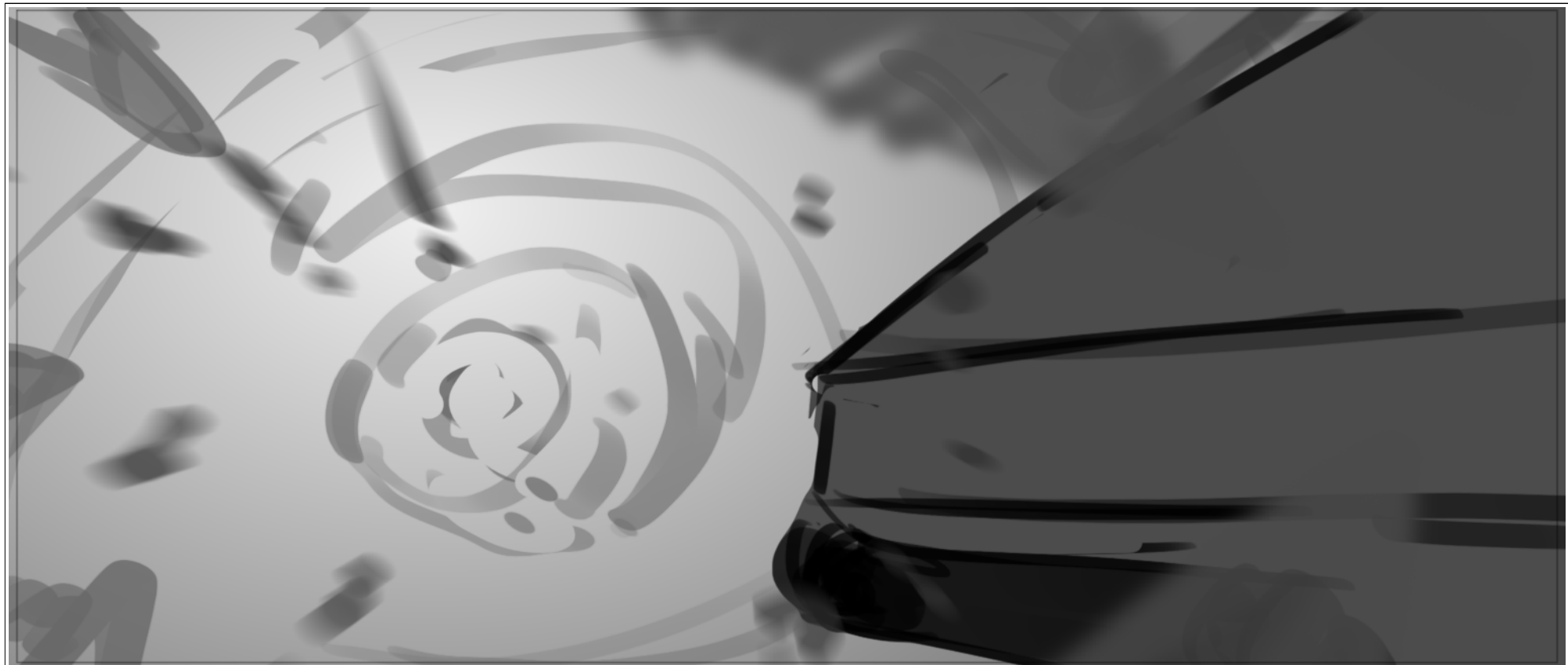

Scene	Duration	Panel	Duration
455	00:20	003B	00:02

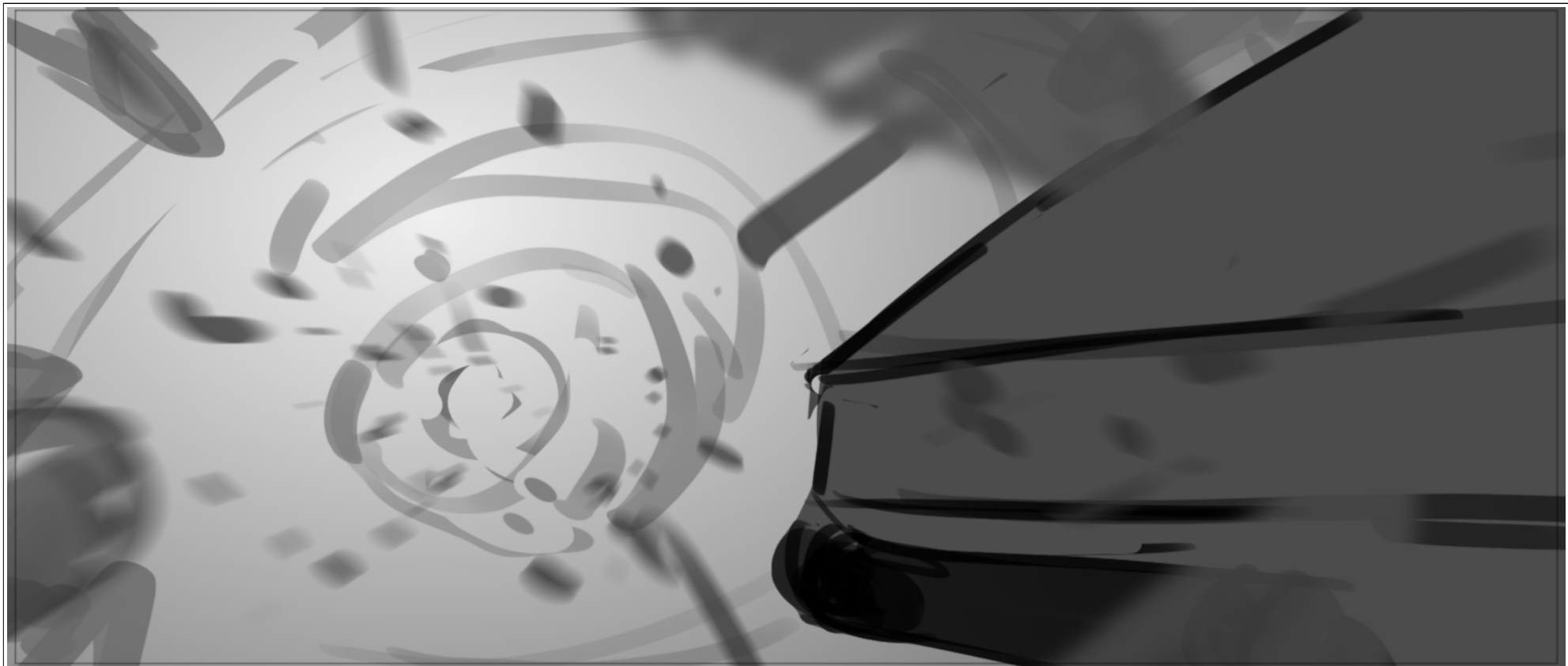

Scene	Duration	Panel	Duration
455	00:20	003C	00:03

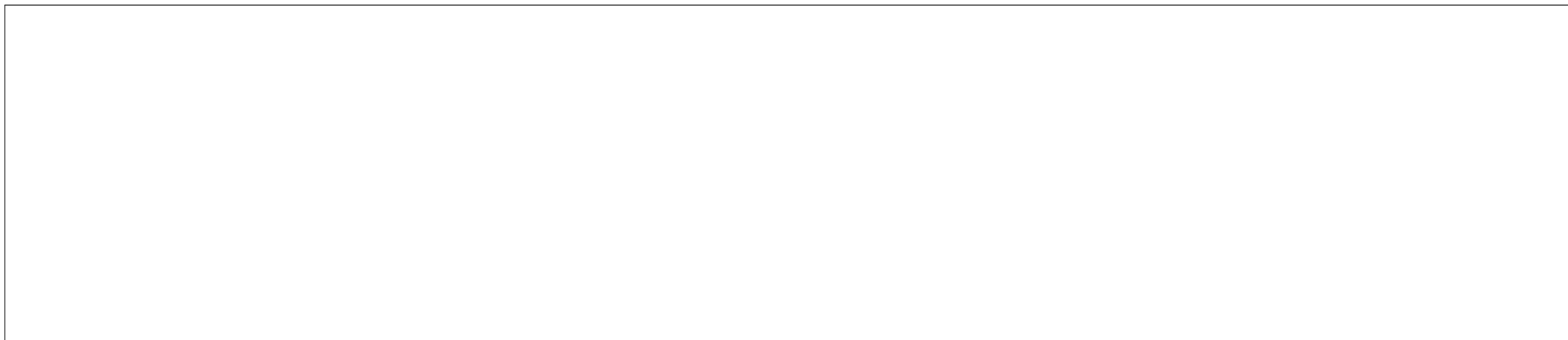
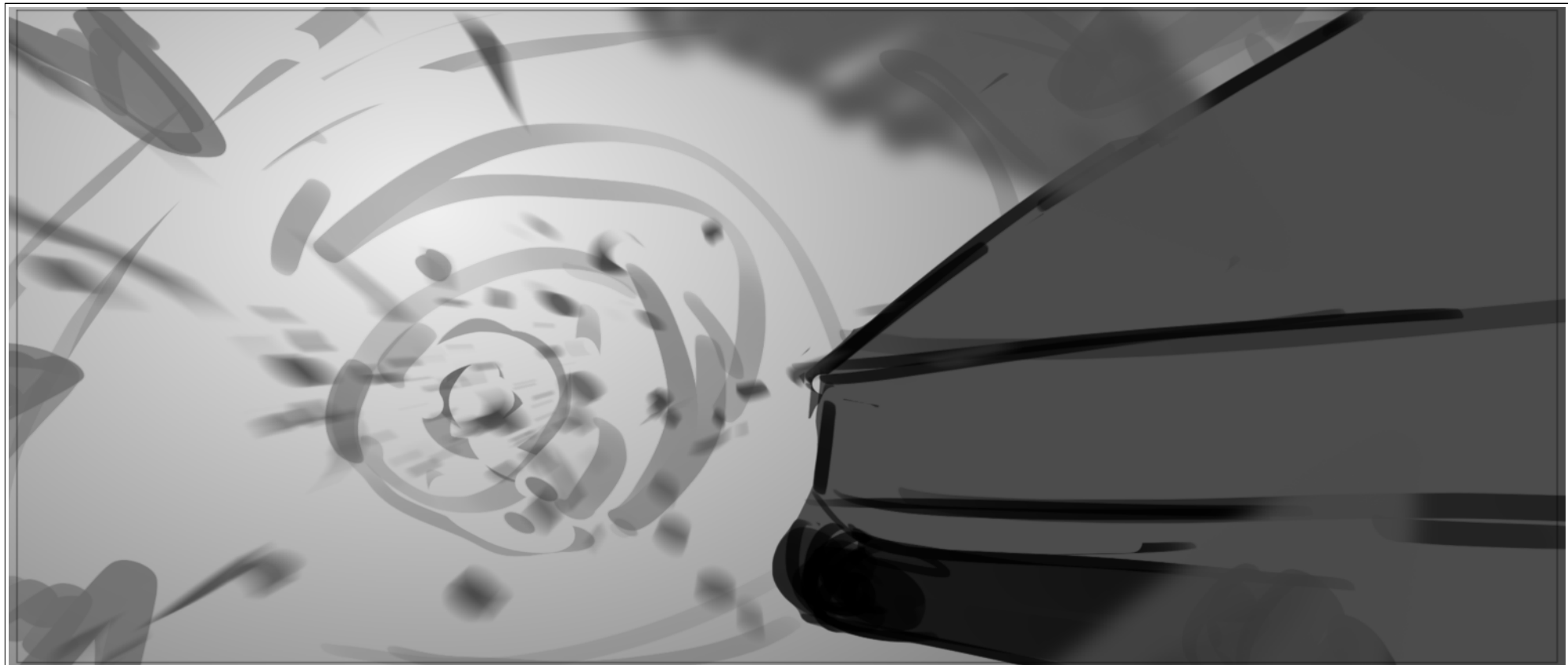

Scene	Duration	Panel	Duration
457	01:13	001	00:12

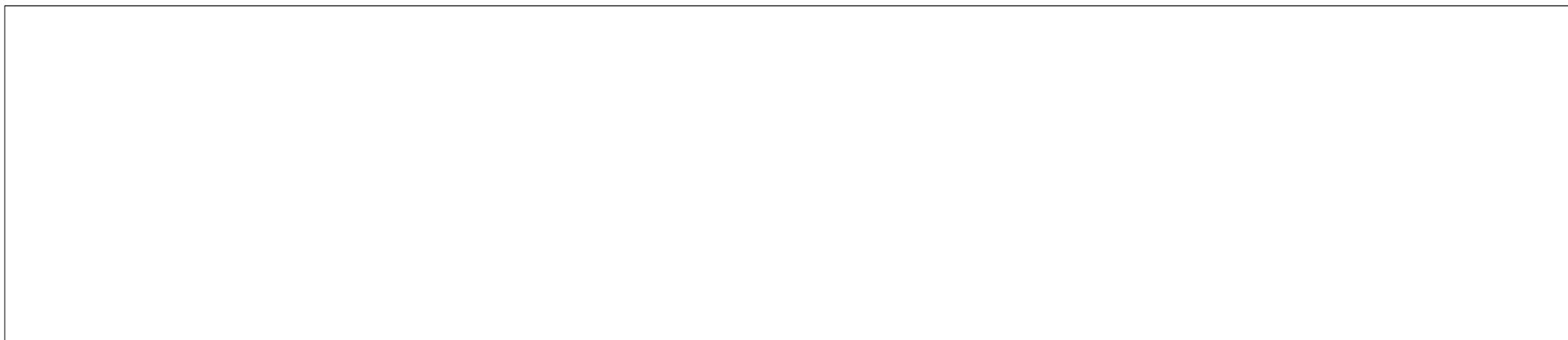
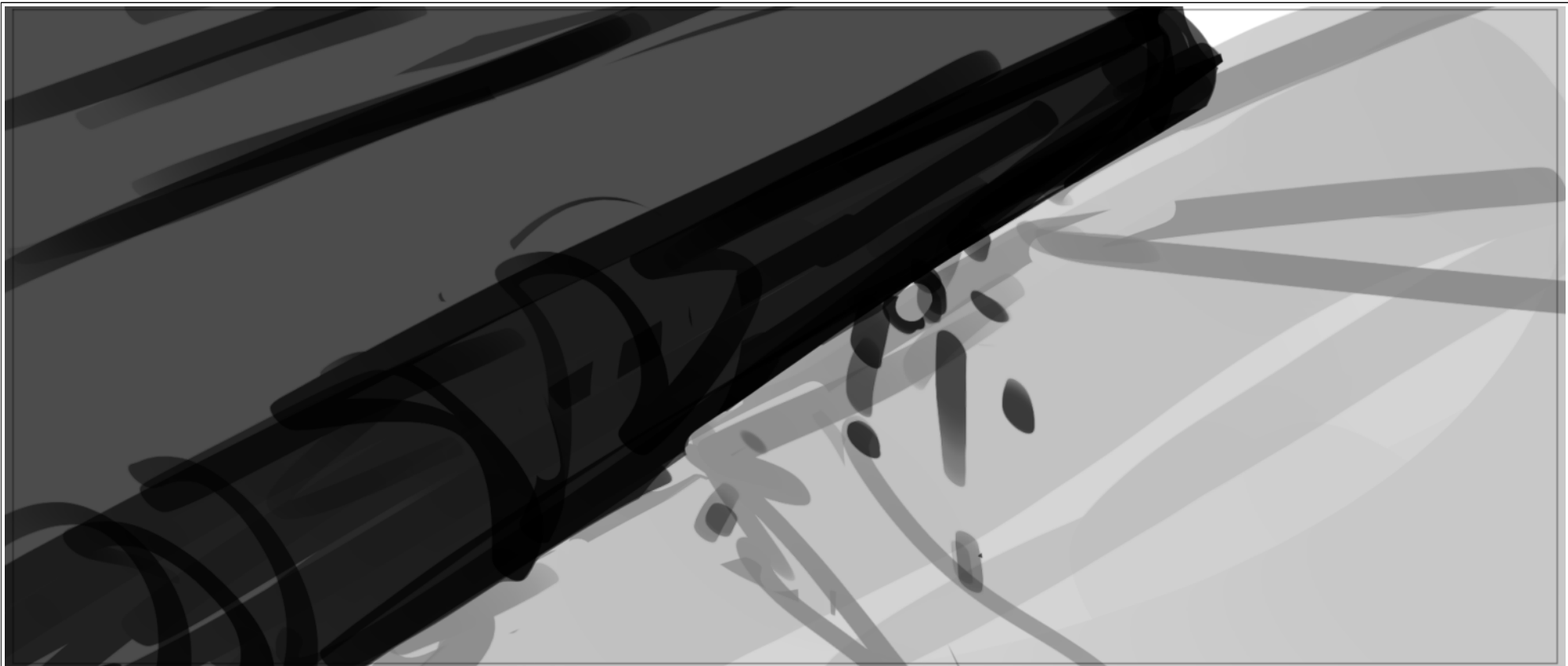

Scene	Duration	Panel	Duration
457	01:13	001A	00:11

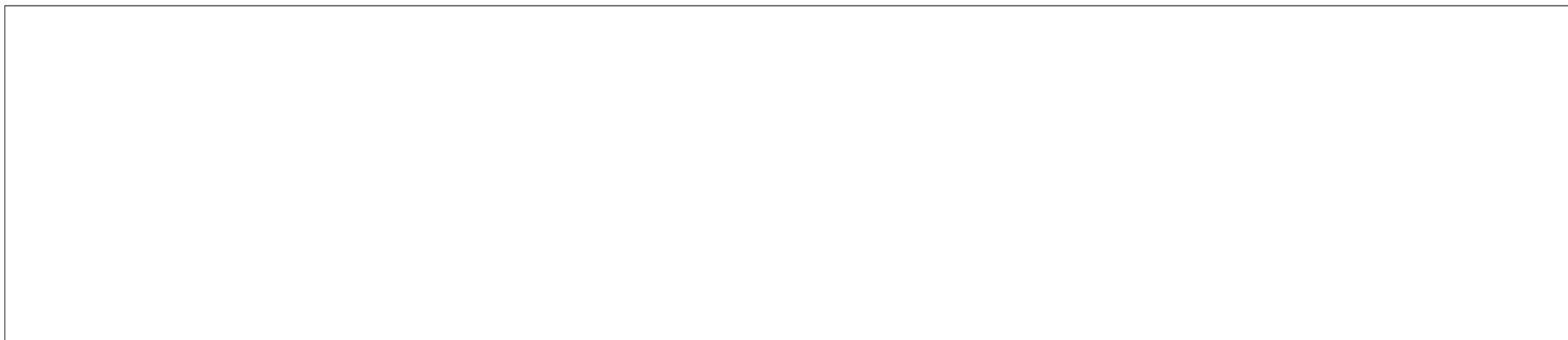
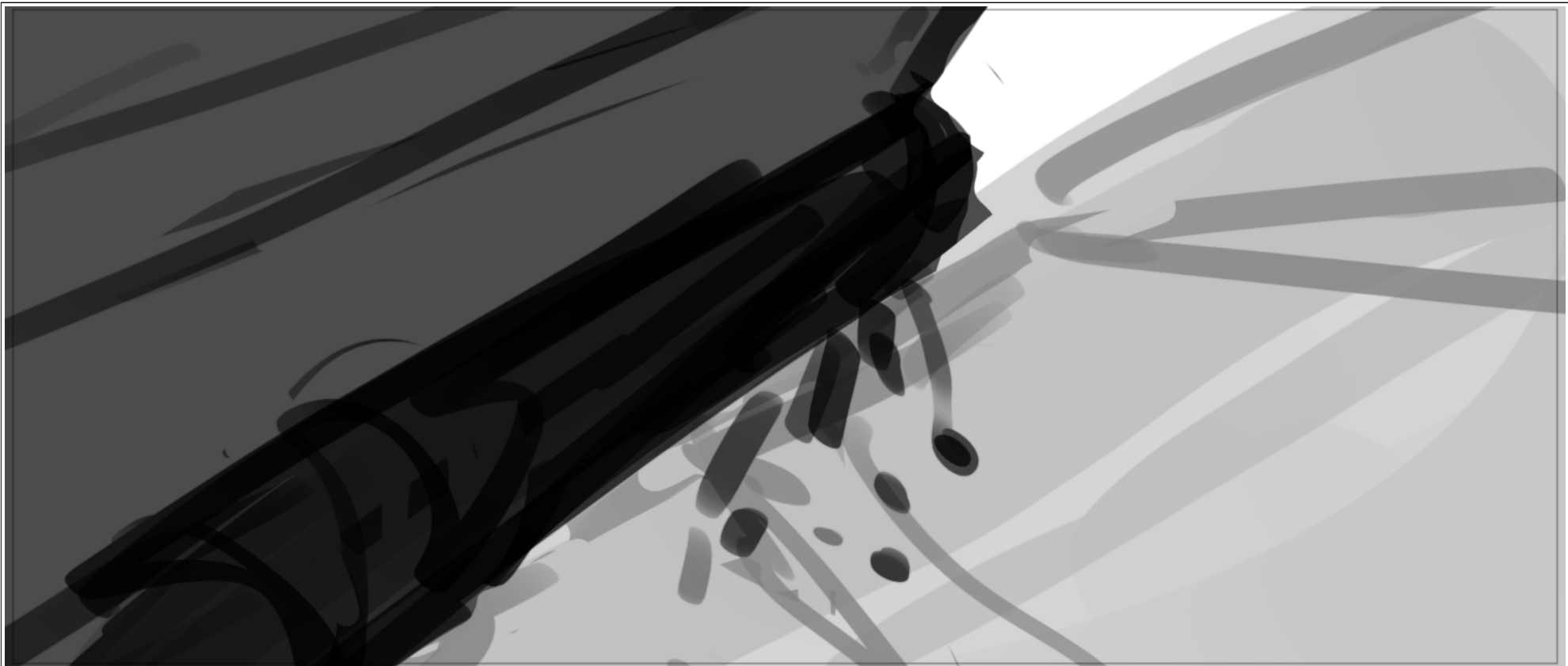

Scene	Duration	Panel	Duration
457	01:13	001B	00:14

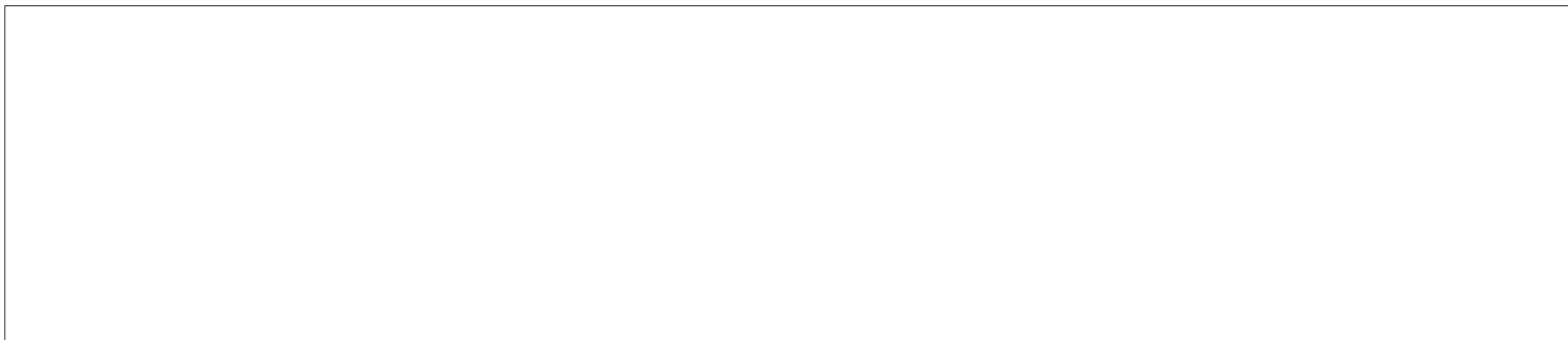
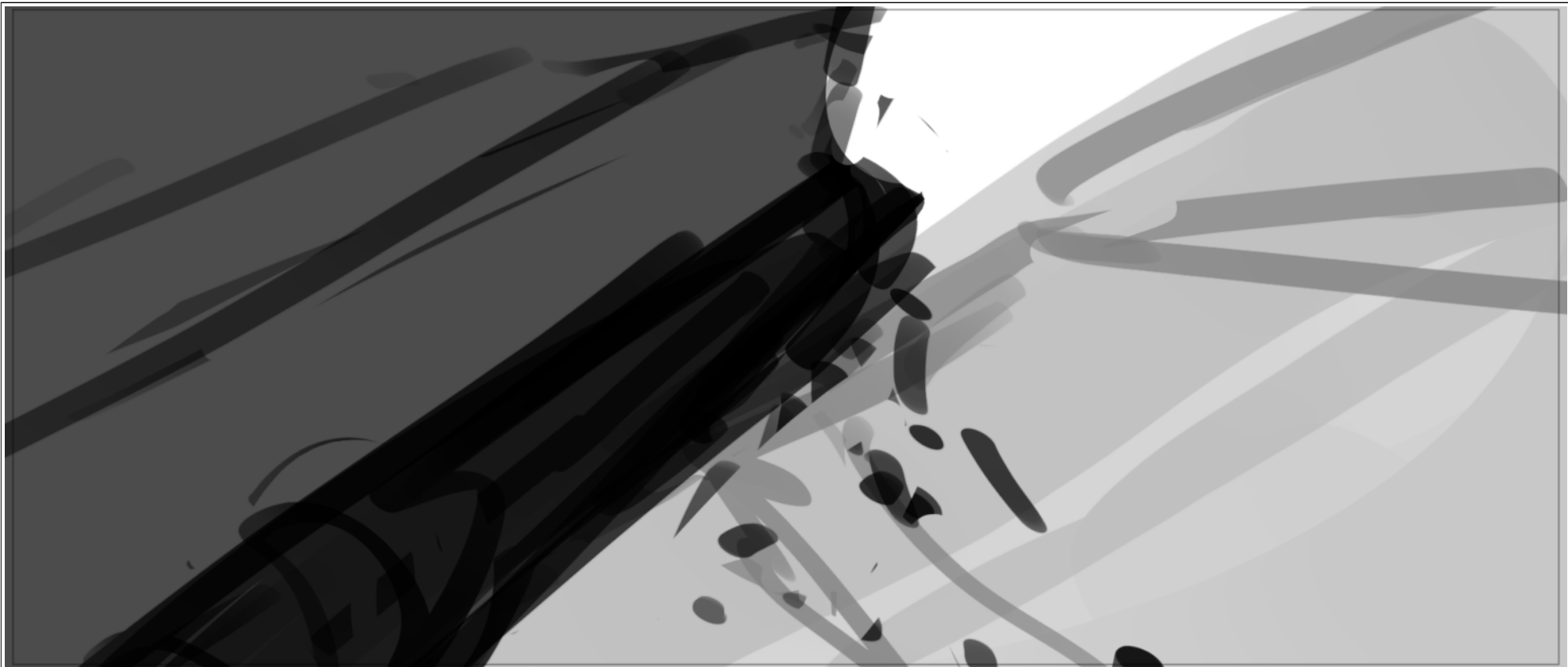

Scene	Duration	Panel	Duration
462	00:23	001	00:07

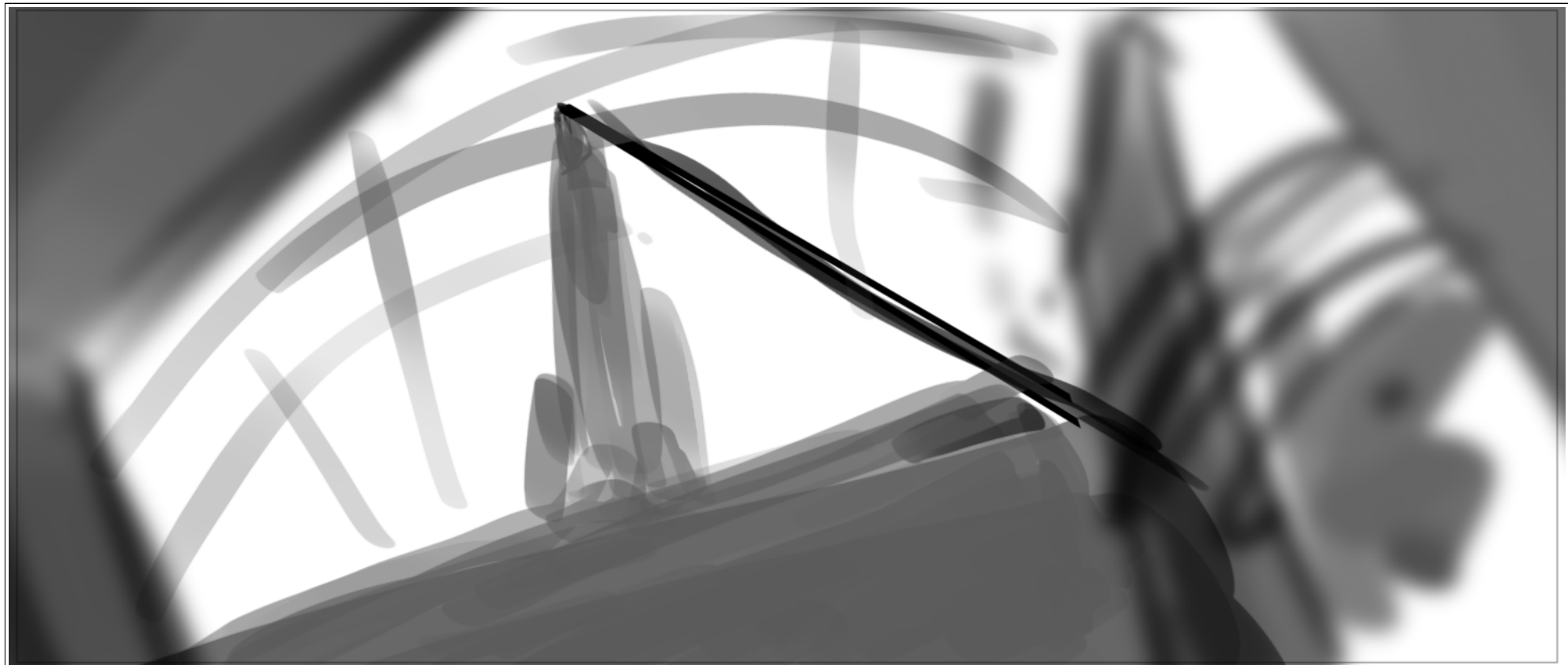

Scene	Duration	Panel	Duration
462	00:23	002	00:08

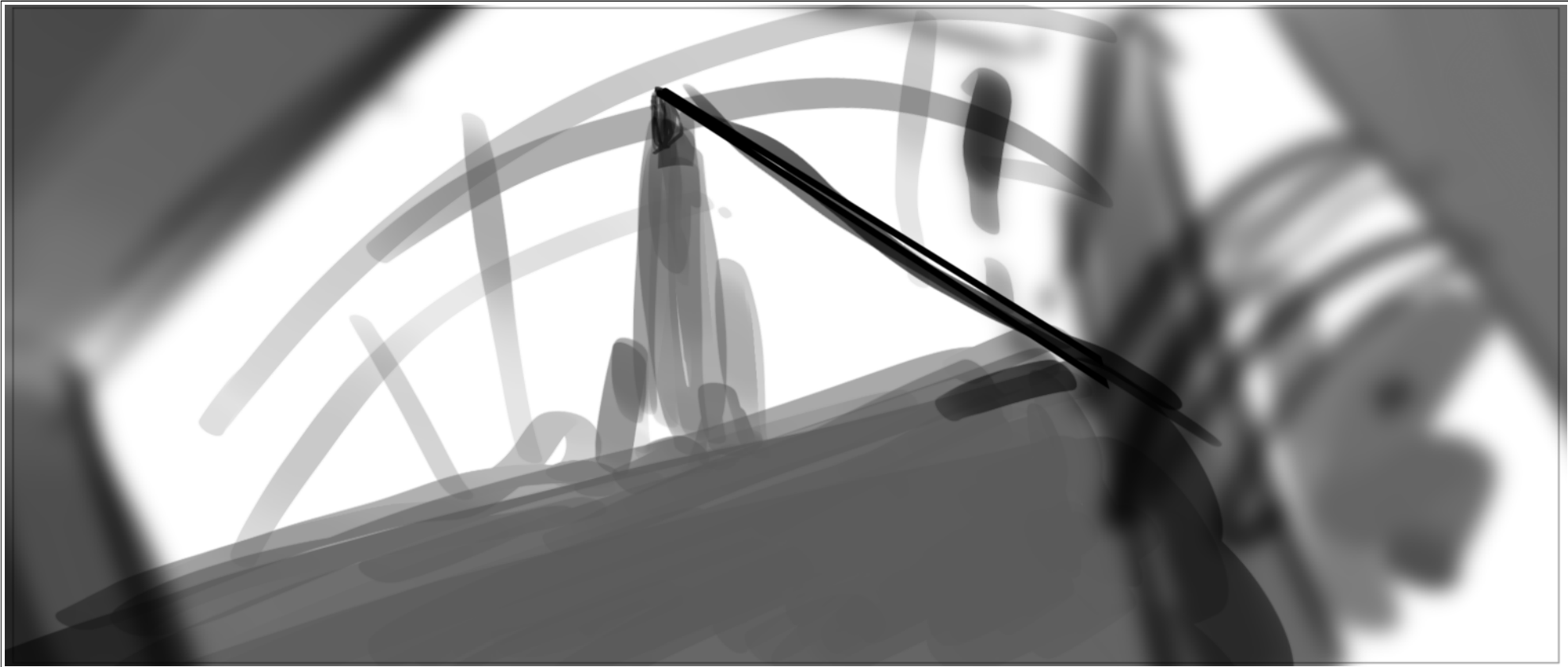

Scene	Duration	Panel	Duration
462	00:23	002A	00:08

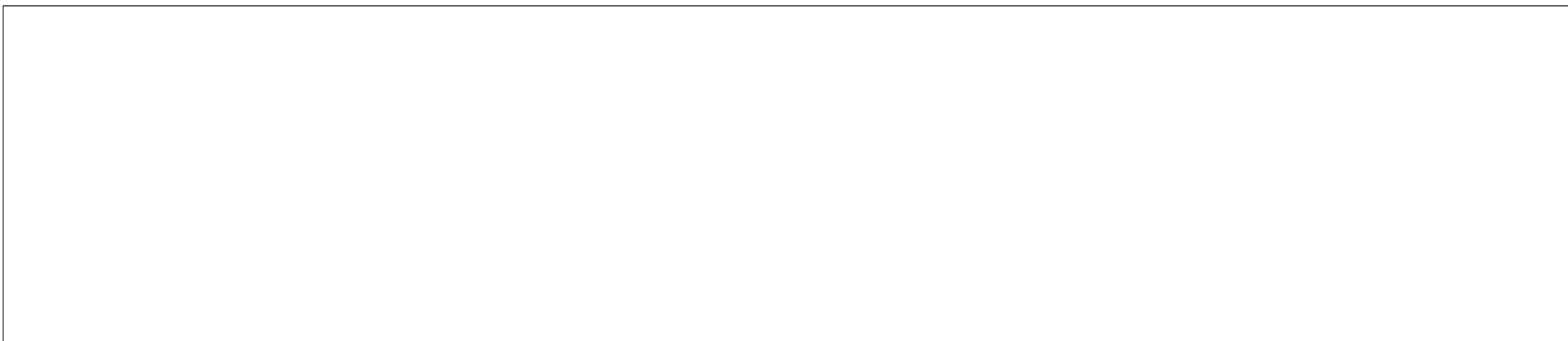
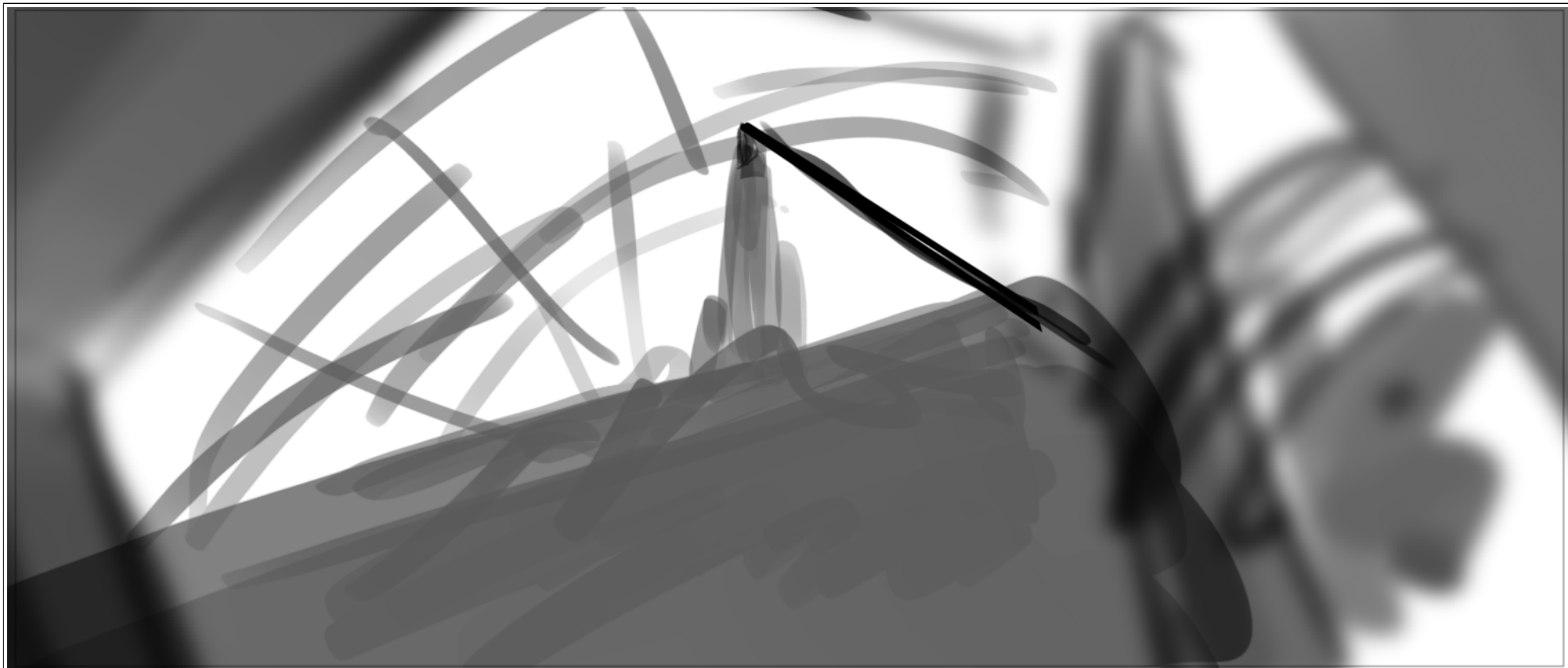

Scene	Duration	Panel	Duration
463	01:22	001	00:10

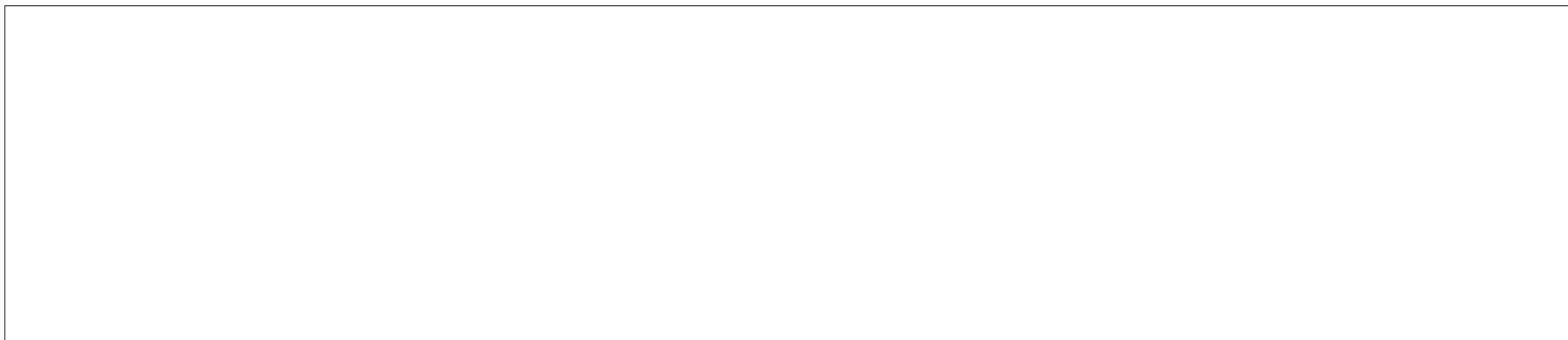
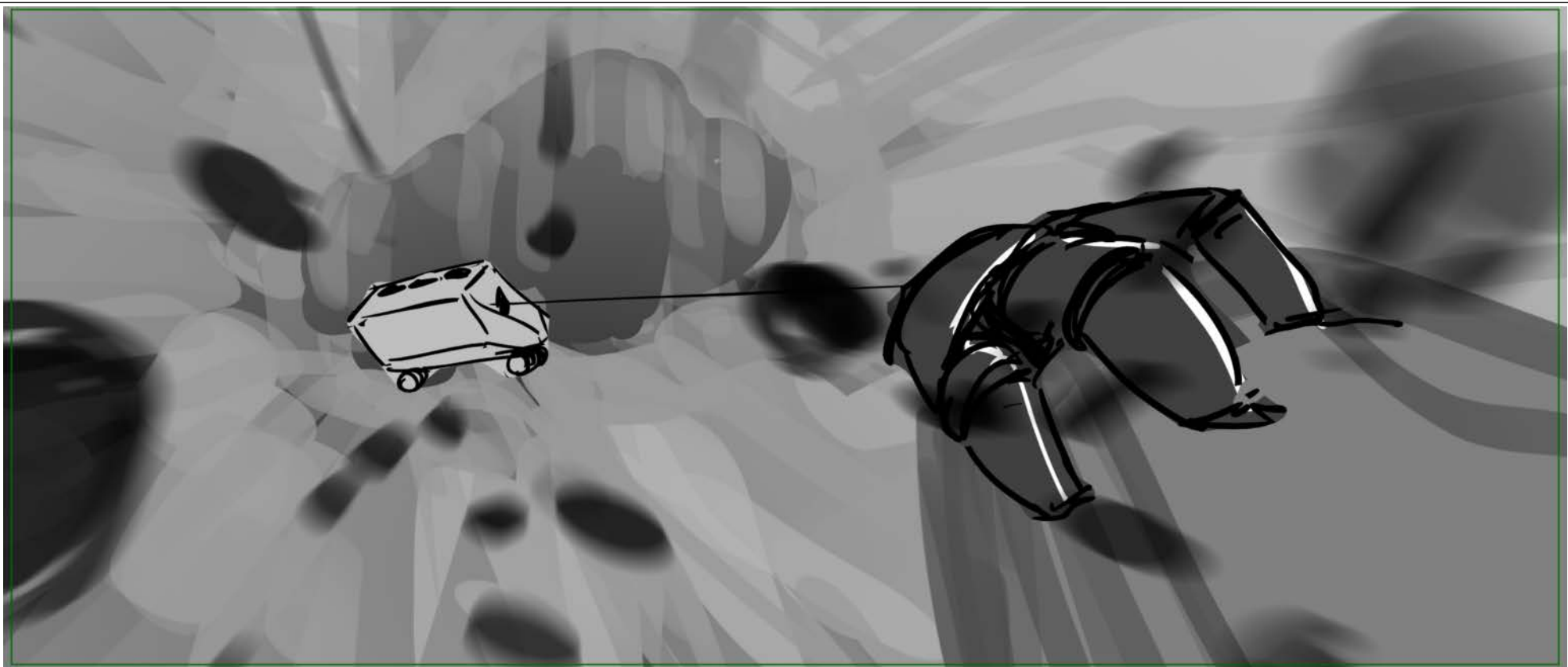

Scene	Duration	Panel	Duration
463	01:22	001A0	00:09

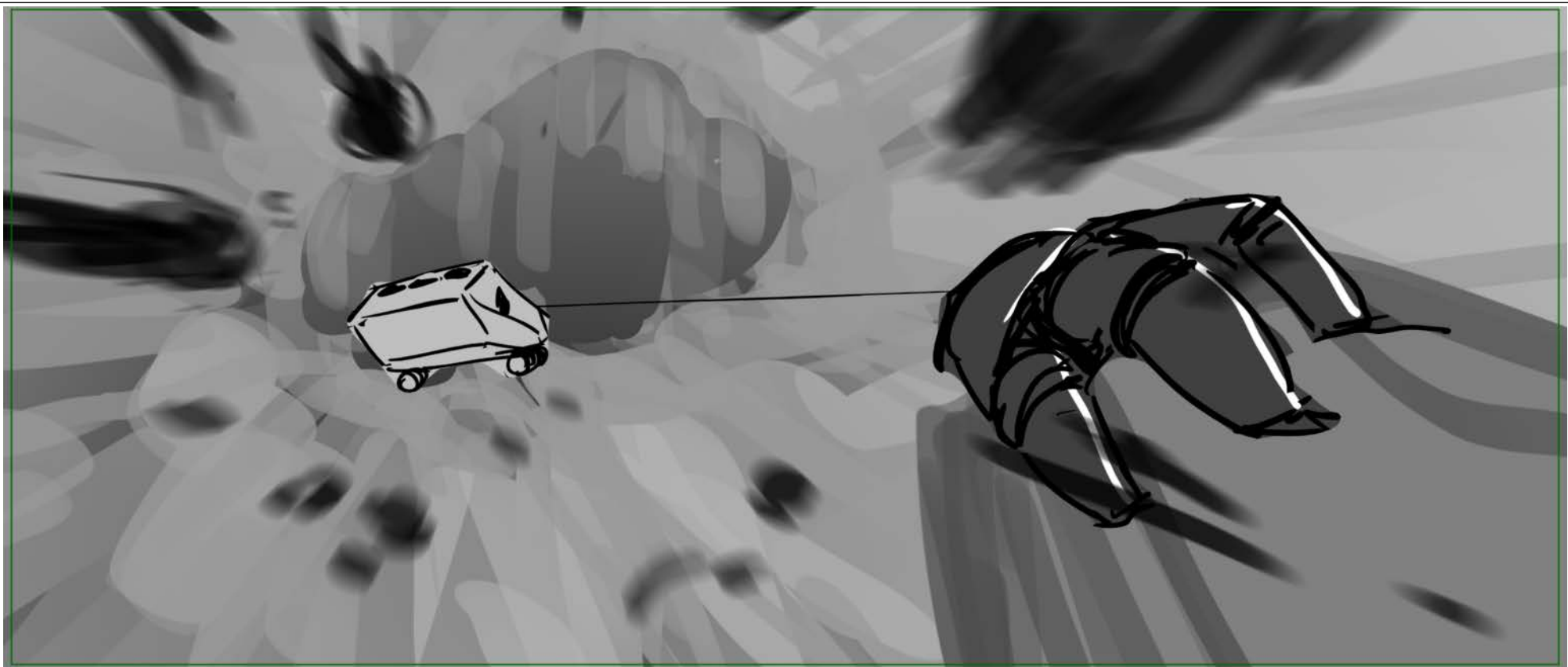

Scene	Duration	Panel	Duration
463	01:22	001A999	00:04

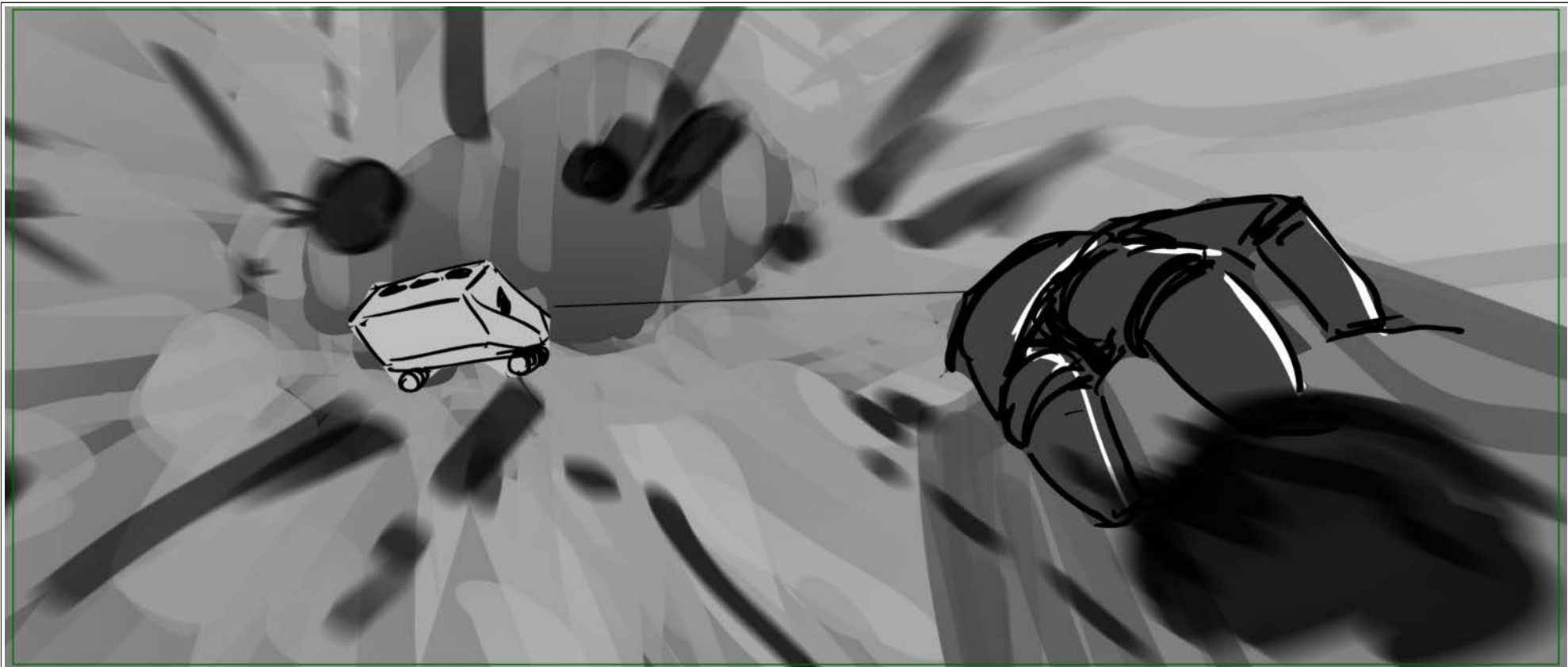

Scene	Duration	Panel	Duration
463	01:22	001A1	00:04

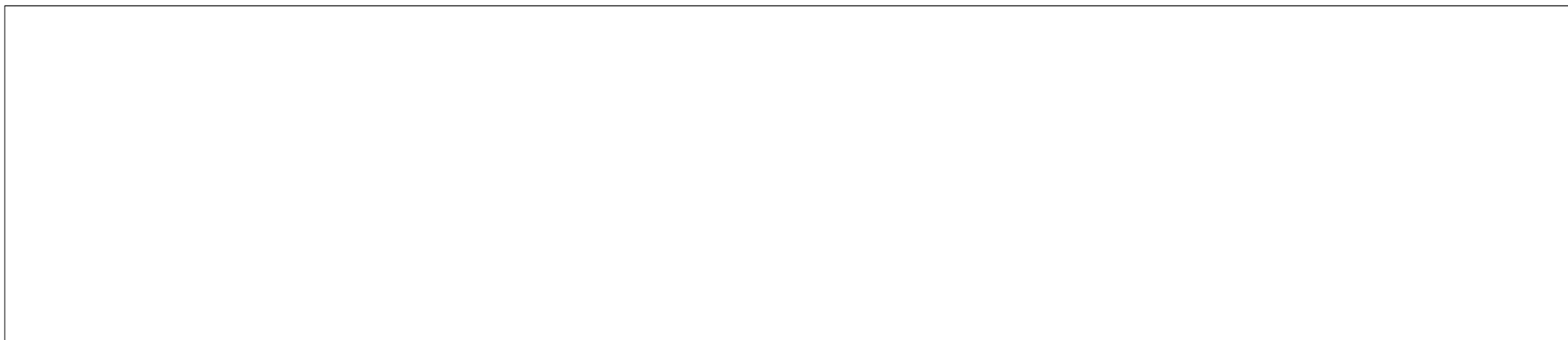
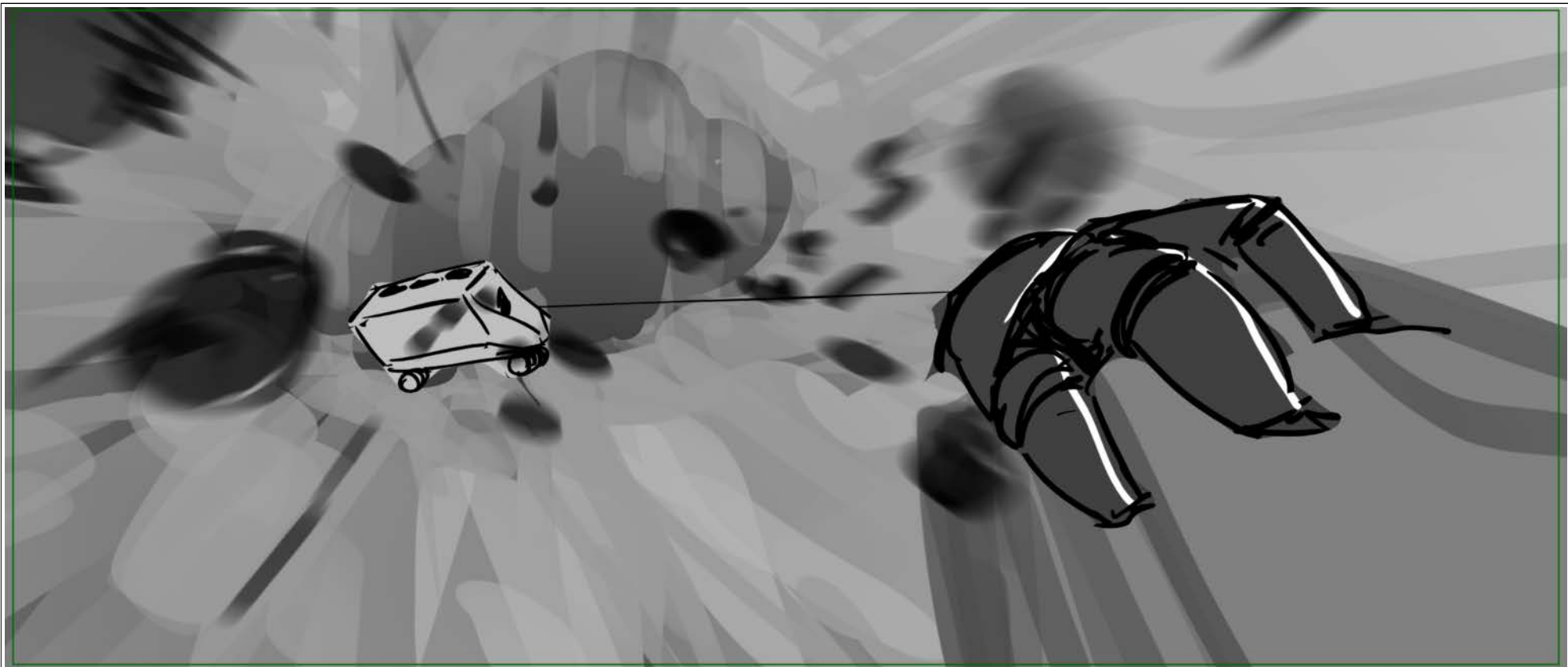

Scene	Duration	Panel	Duration
463	01:22	001B000	00:04

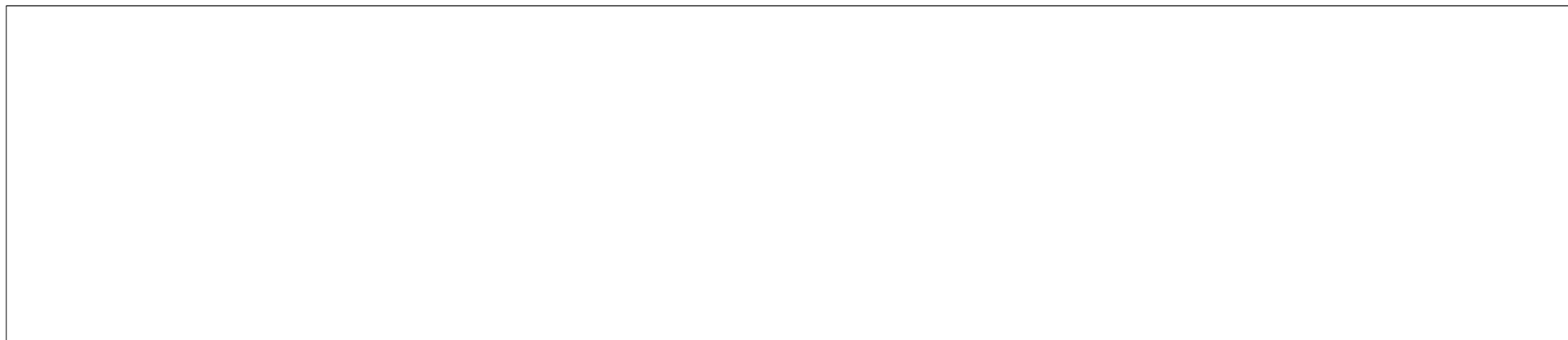
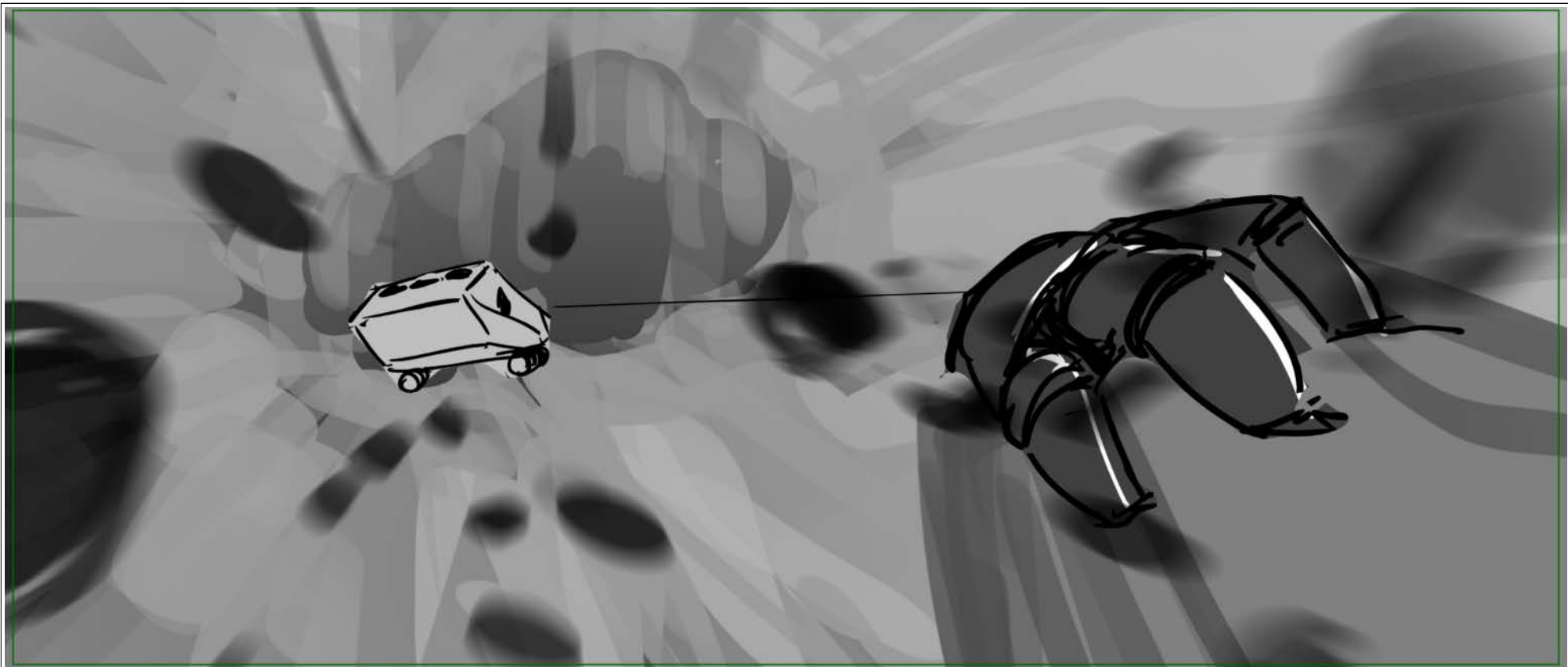

Scene	Duration	Panel	Duration
463	01:22	001A2	00:04

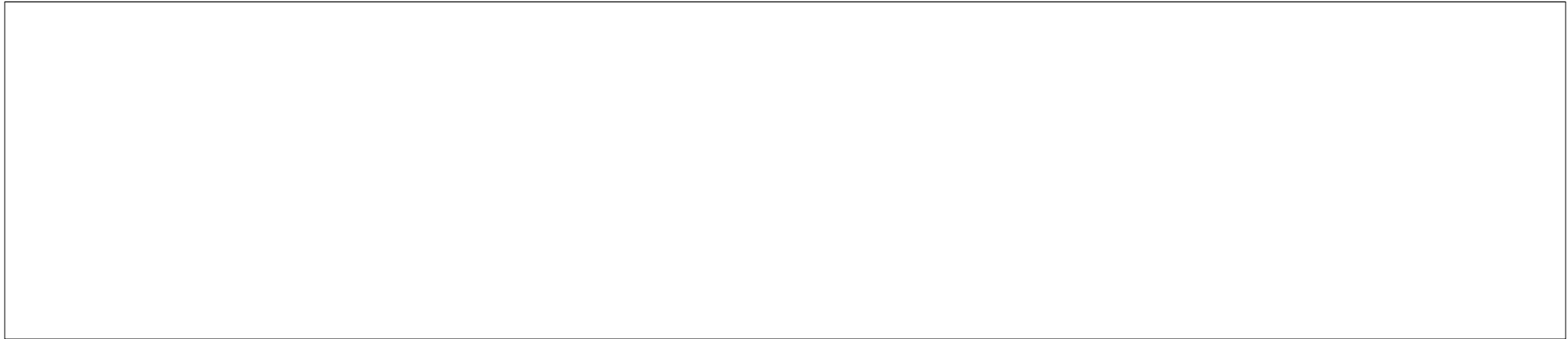
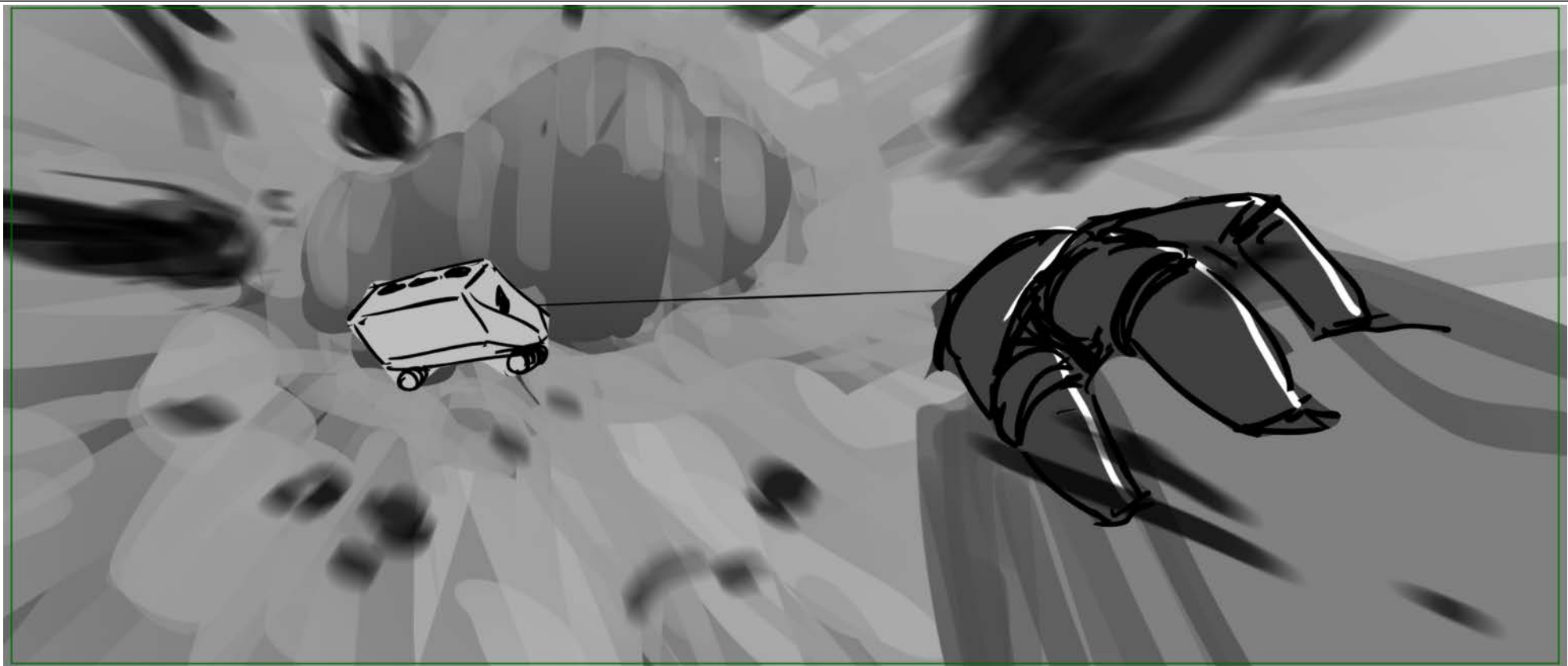

Scene	Duration	Panel	Duration
463	01:22	001A	00:05

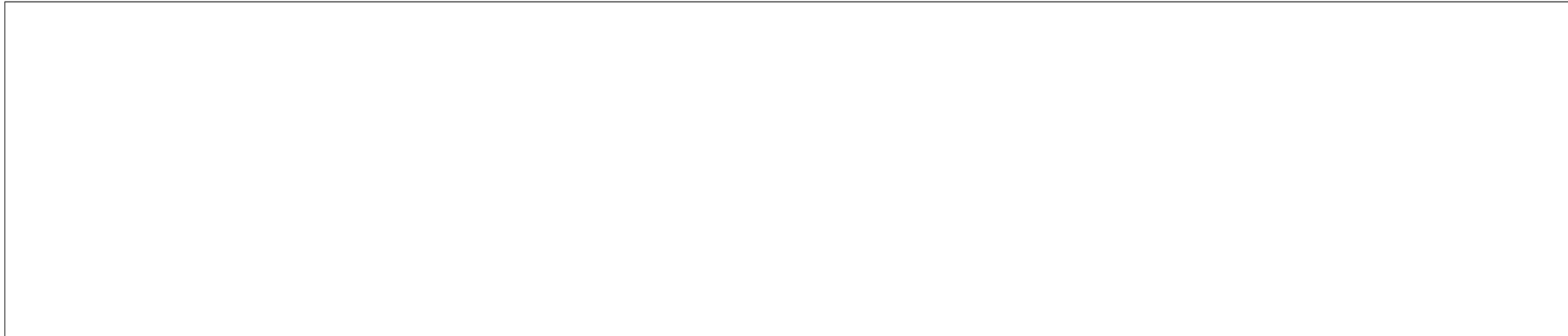
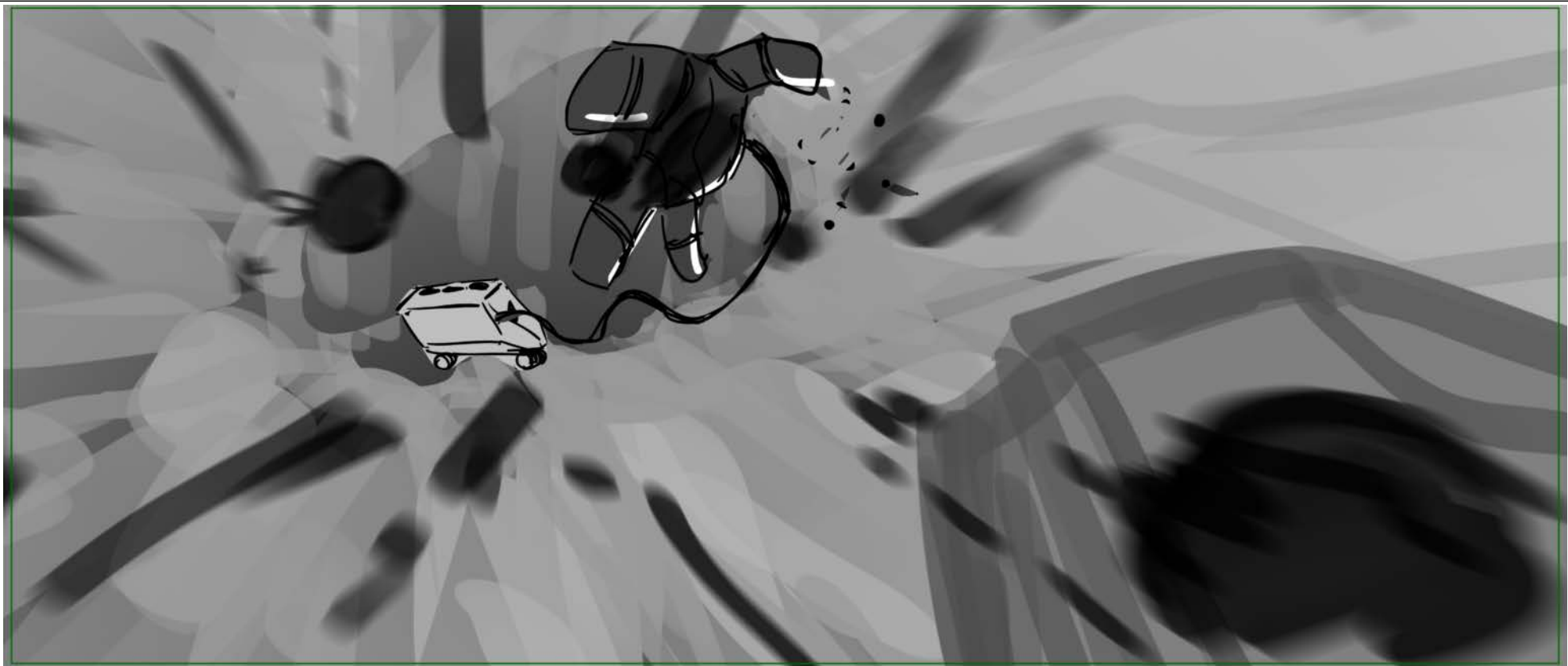

Scene	Duration	Panel	Duration
463	01:22	02A	00:06

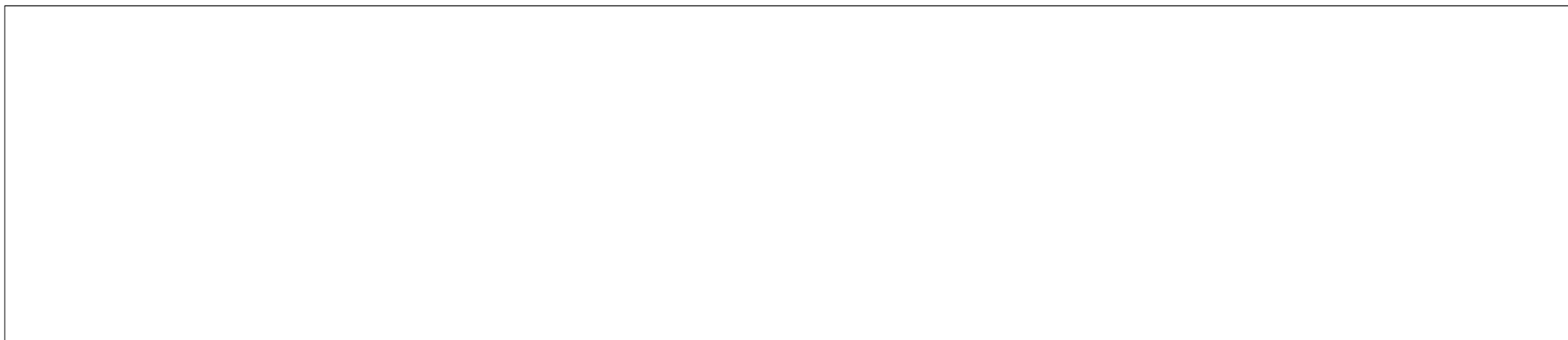
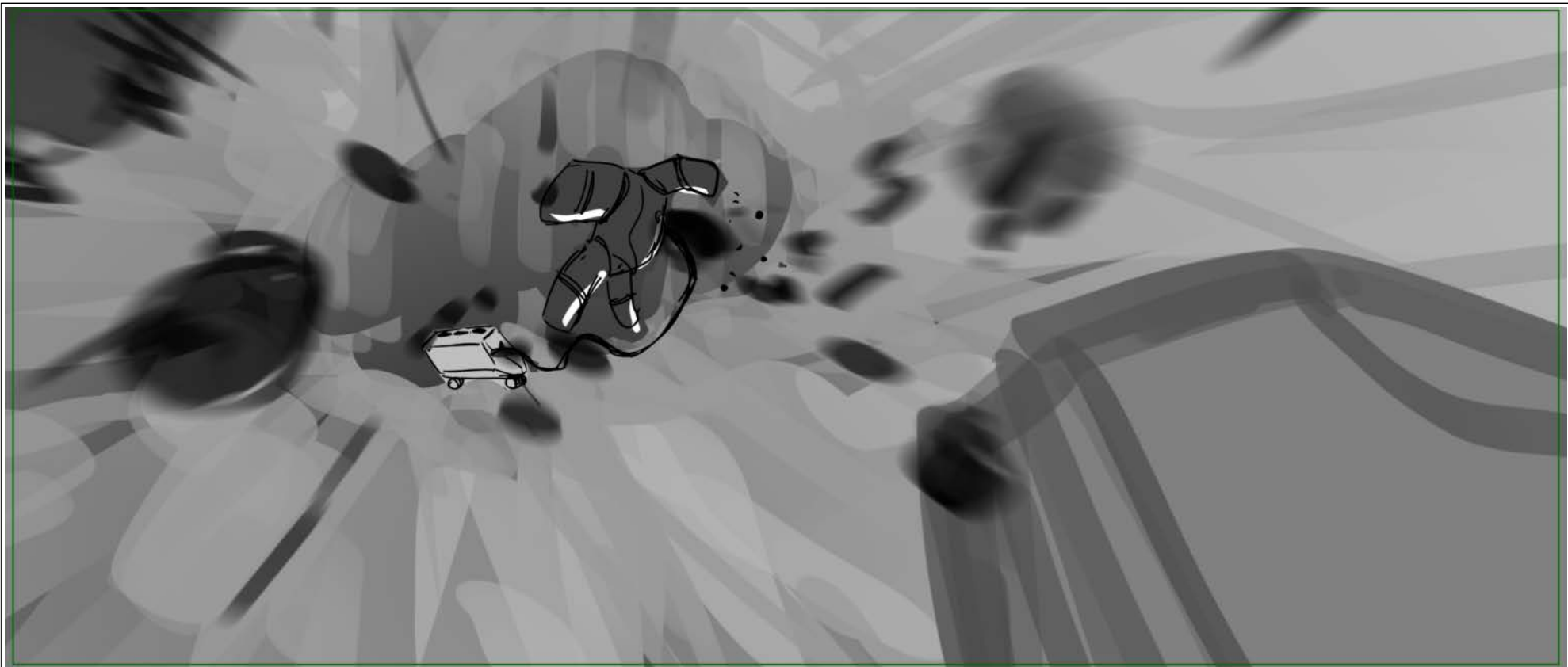

Scene	Duration	Panel	Duration
465	01:19	001	00:07

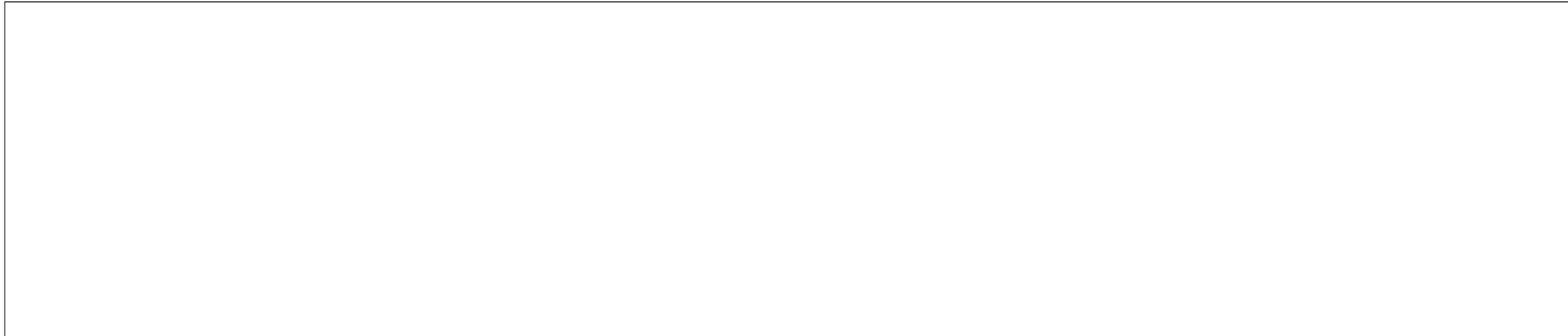

Scene	Duration	Panel	Duration
465	01:19	001B000	00:04

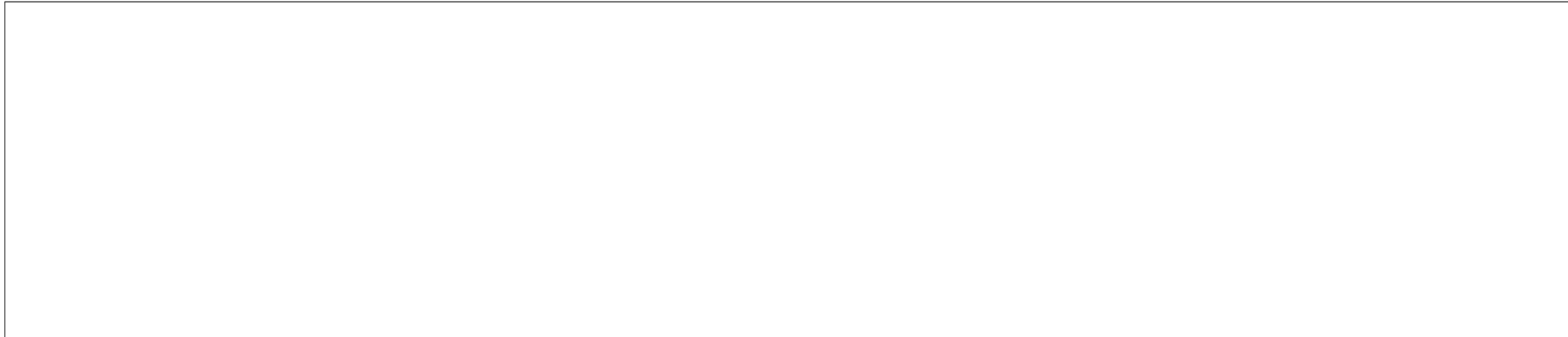
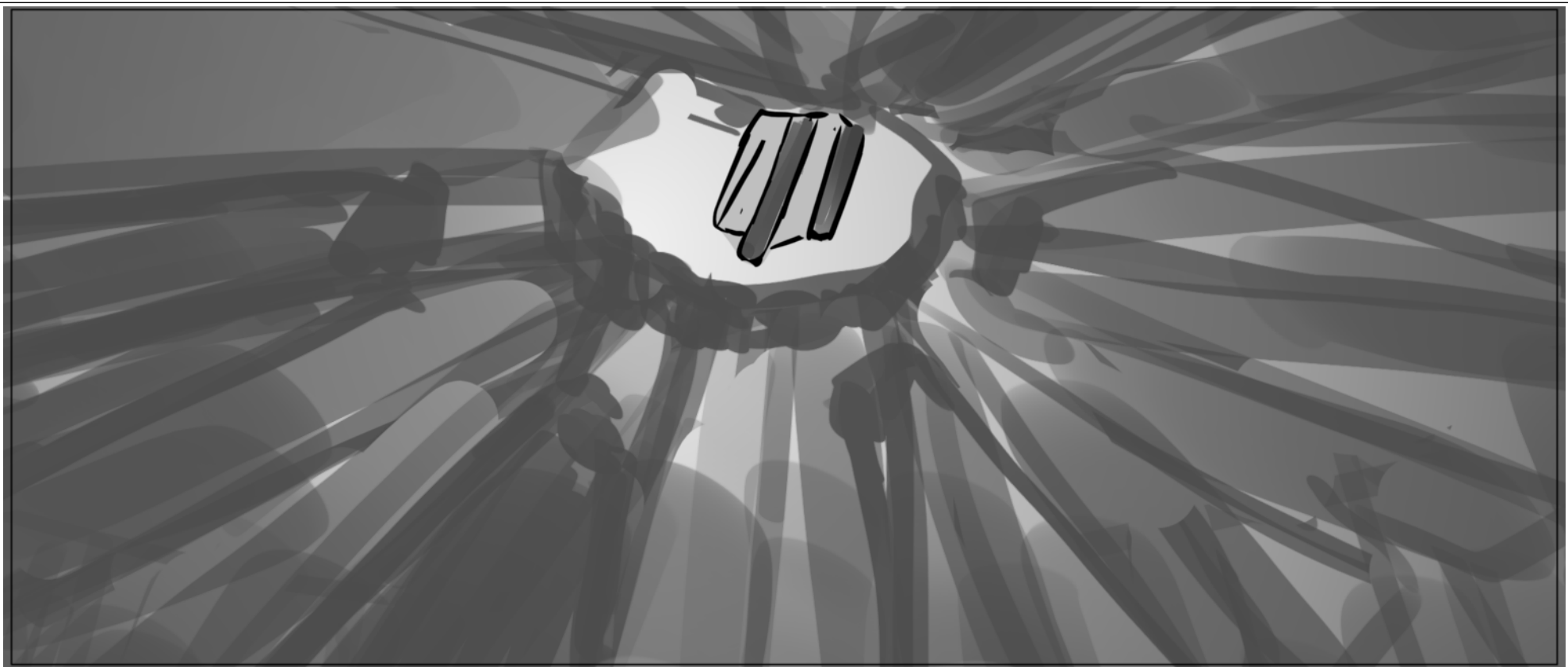

Scene	Duration	Panel	Duration
465	01:19	001A0	00:06

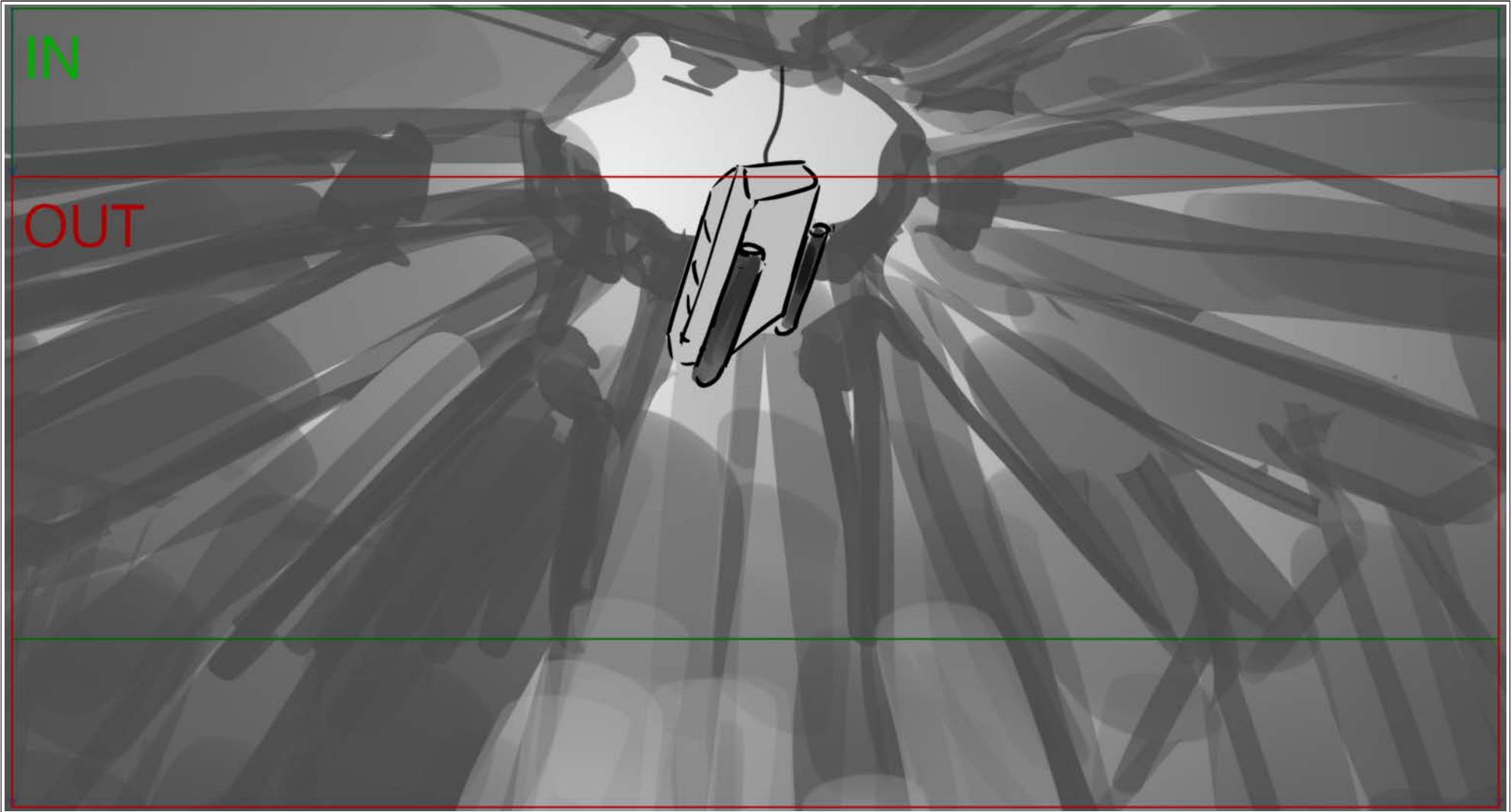

Scene	Duration	Panel	Duration
465	01:19	001A	00:08



Action Notes

GALILEO STARTS FALLING

Scene	Duration	Panel	Duration
465	01:19	002	00:03

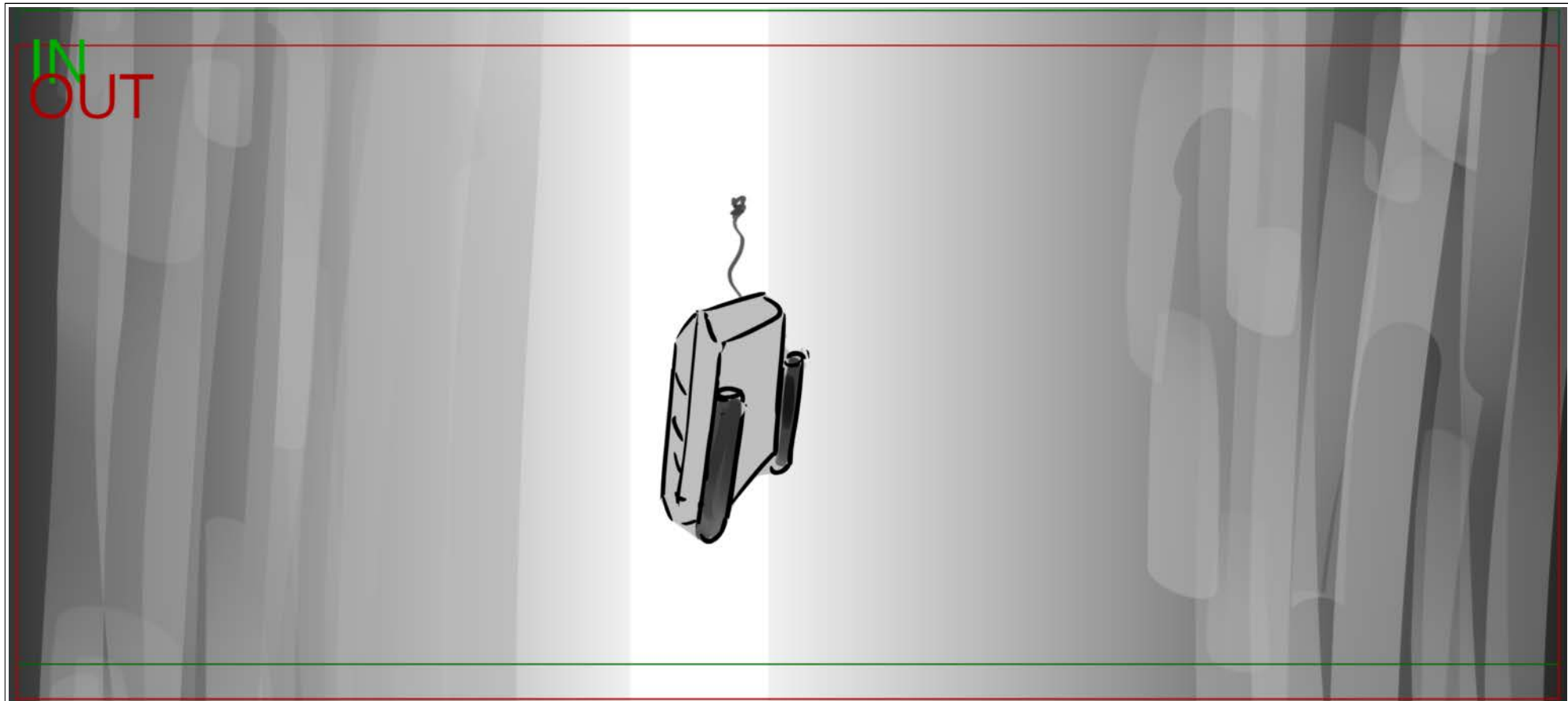

Scene	Duration	Panel	Duration
465	01:19	002A	00:03

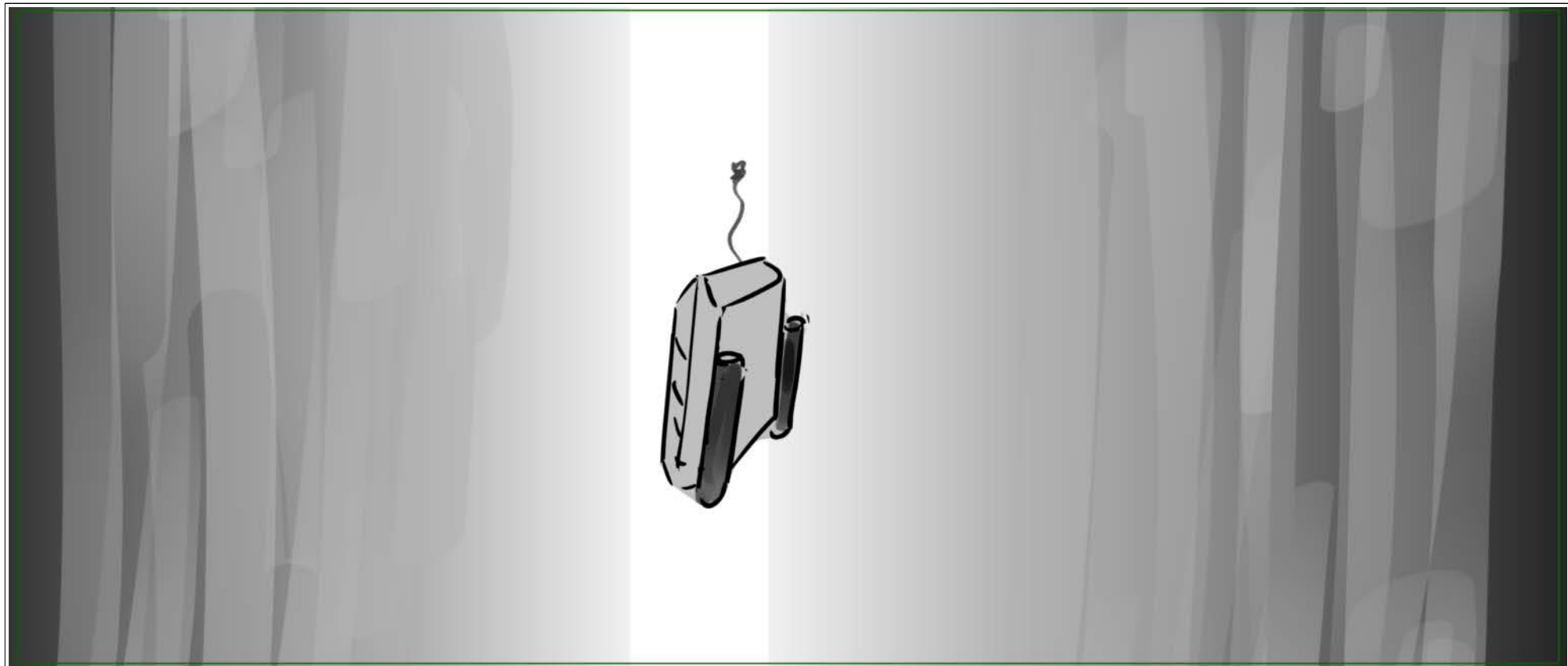

Scene	Duration	Panel	Duration
465	01:19	002A0	00:03

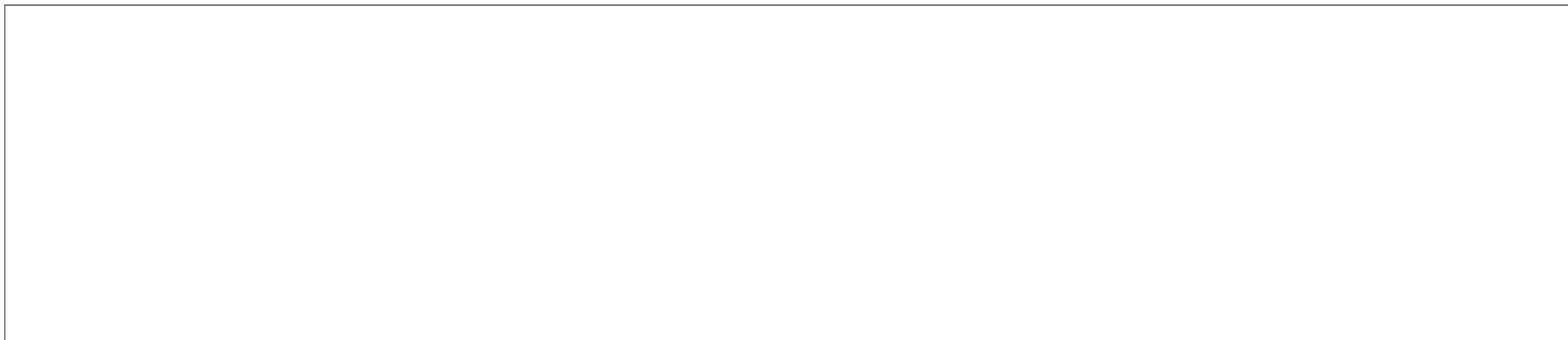
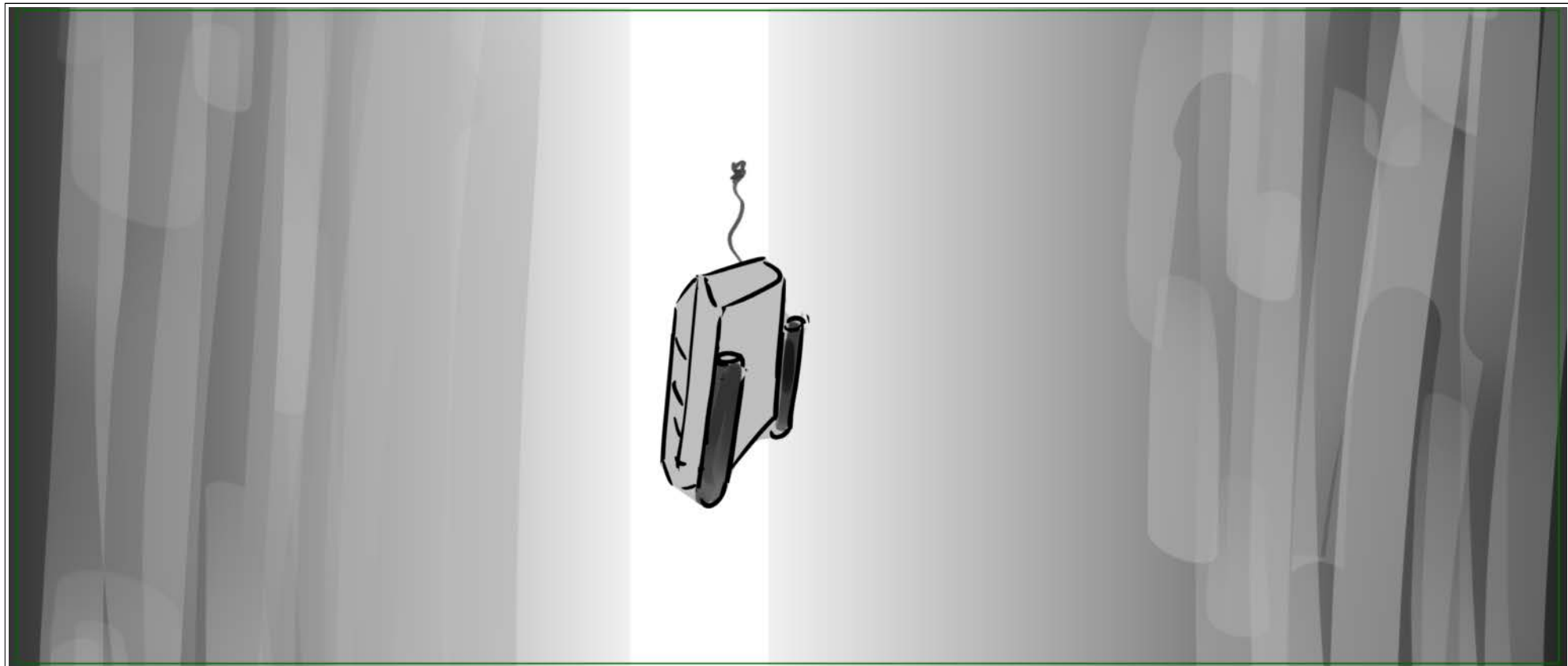

Scene	Duration	Panel	Duration
465	01:19	002B	00:03

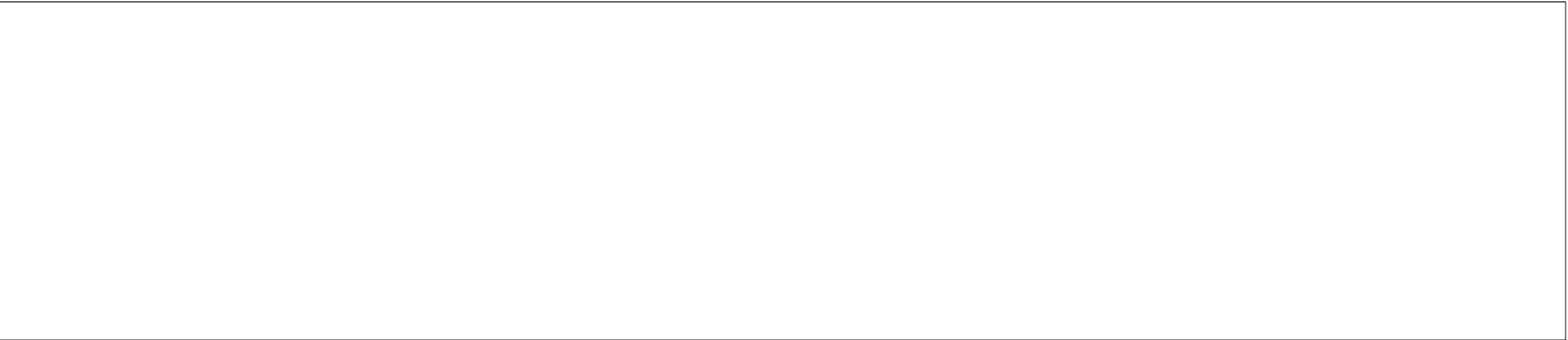
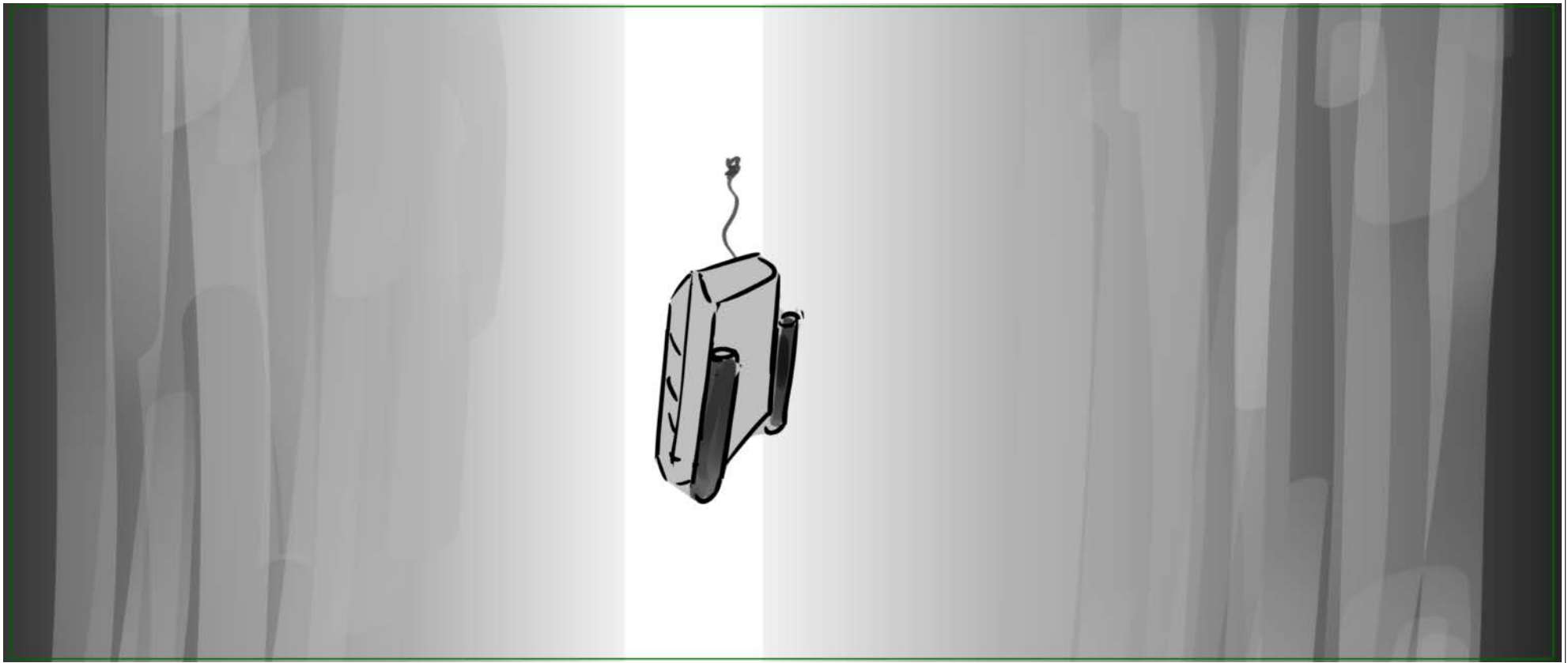

Scene	Duration	Panel	Duration
465	01:19	002A1	00:03

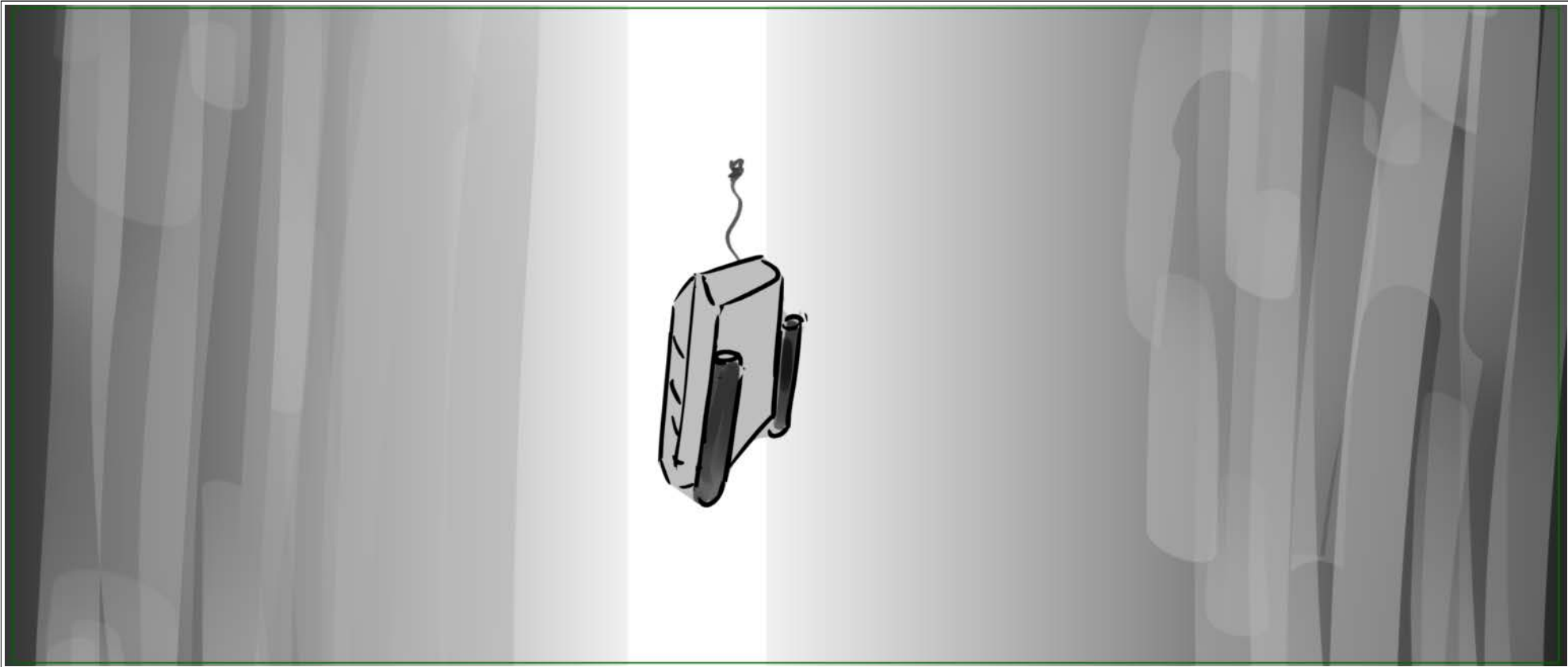

Scene	Duration	Panel	Duration
465	01:19	002C	00:03

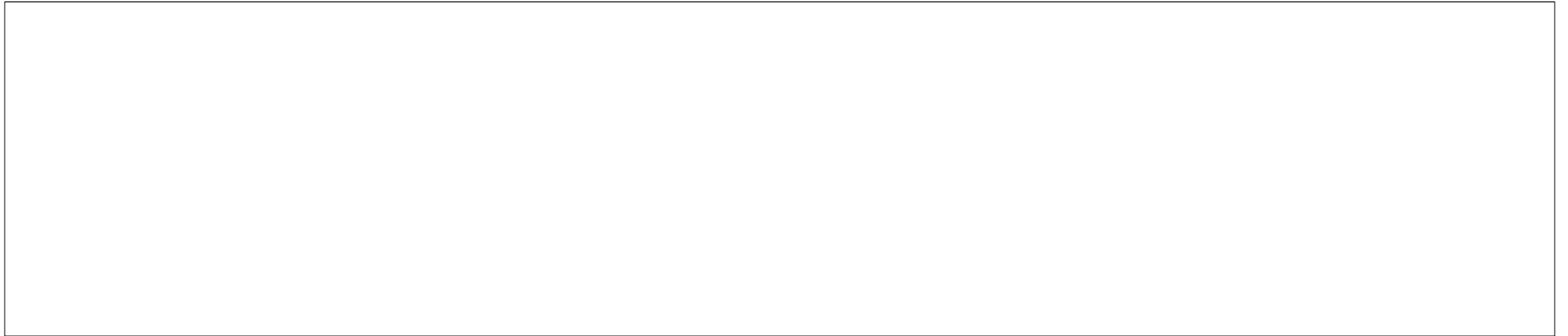
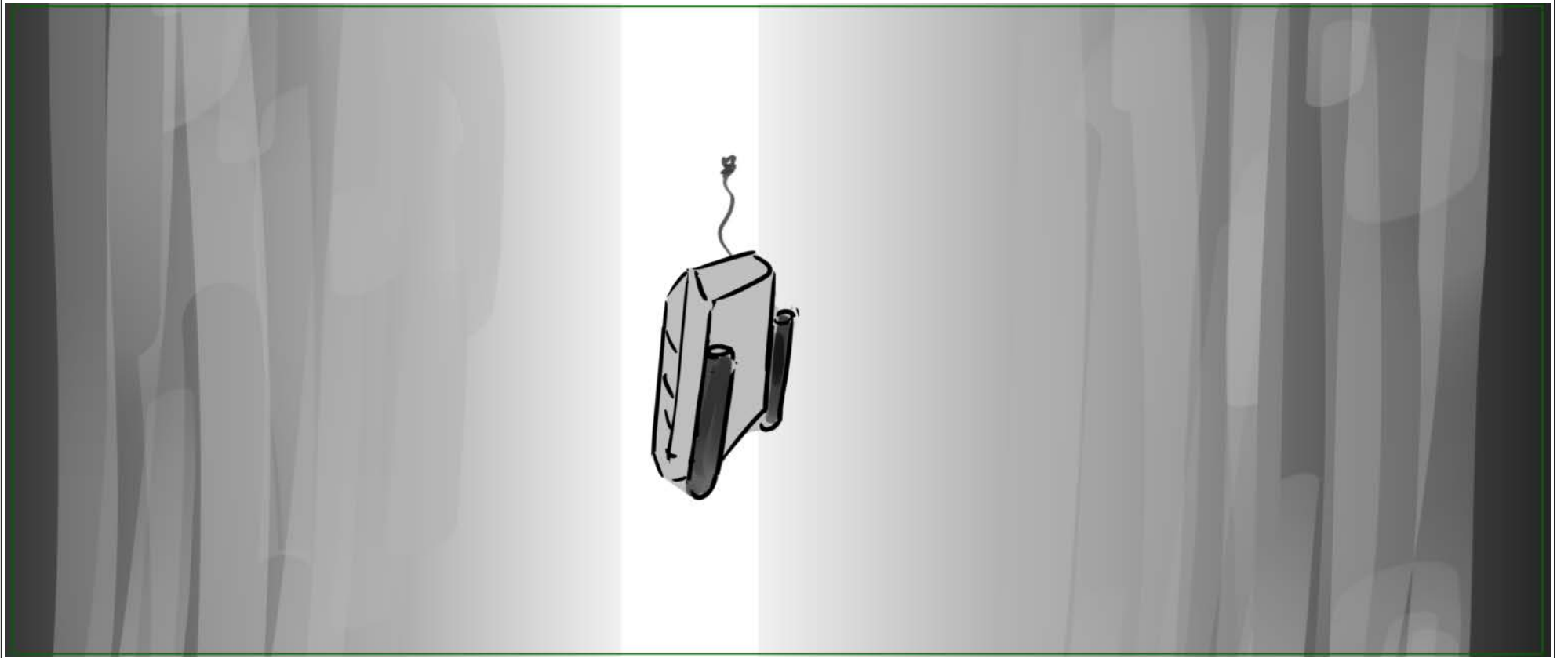

Scene	470	Duration	01:00	Panel	001	Duration	01:00
-------	-----	----------	-------	-------	-----	----------	-------

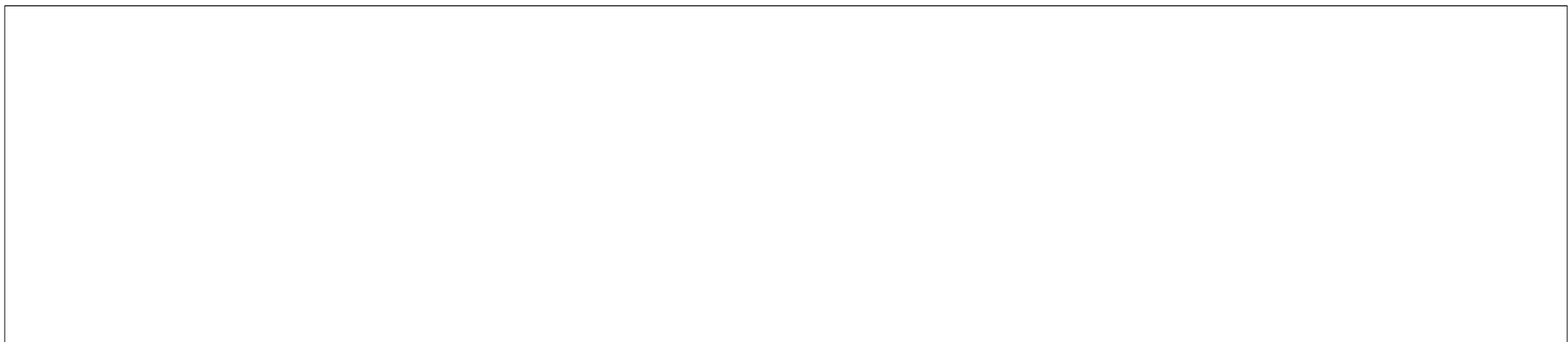
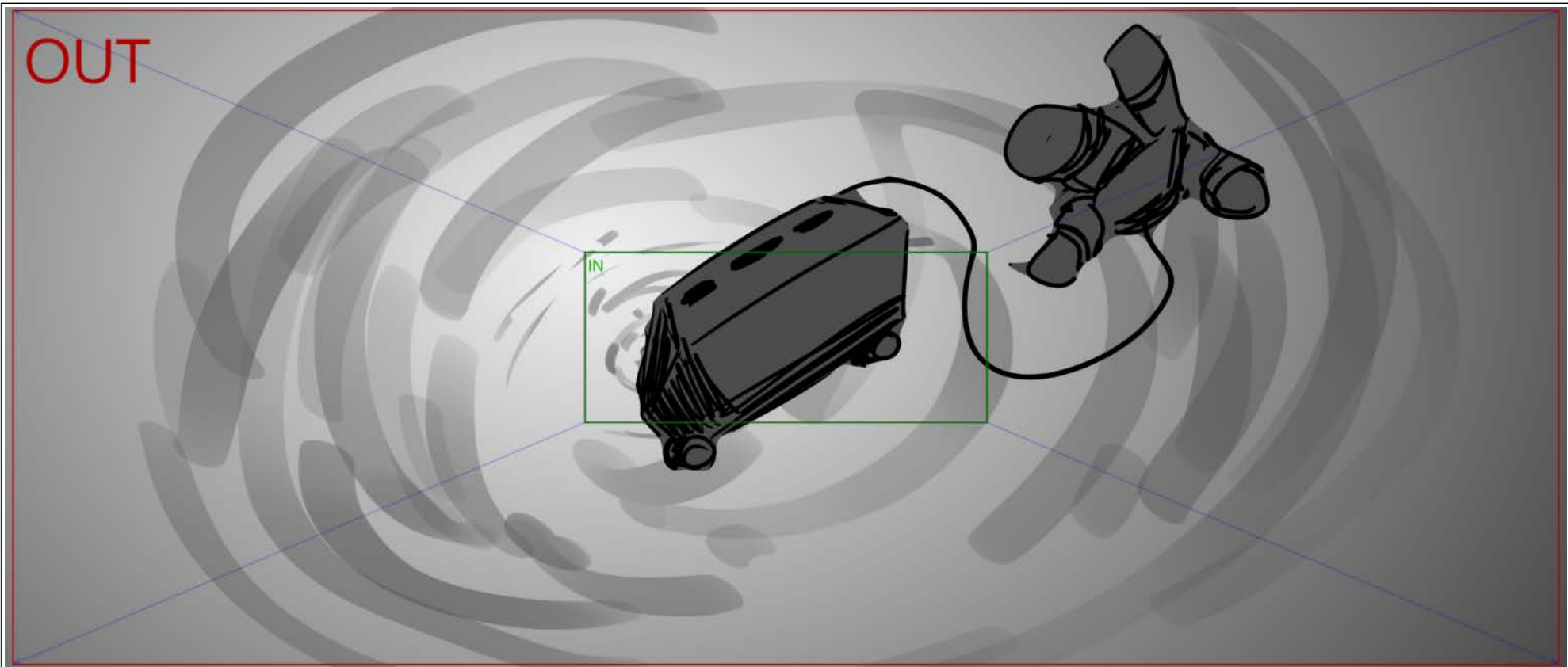

Scene	Duration	Panel	Duration
480	01:00	001	00:11

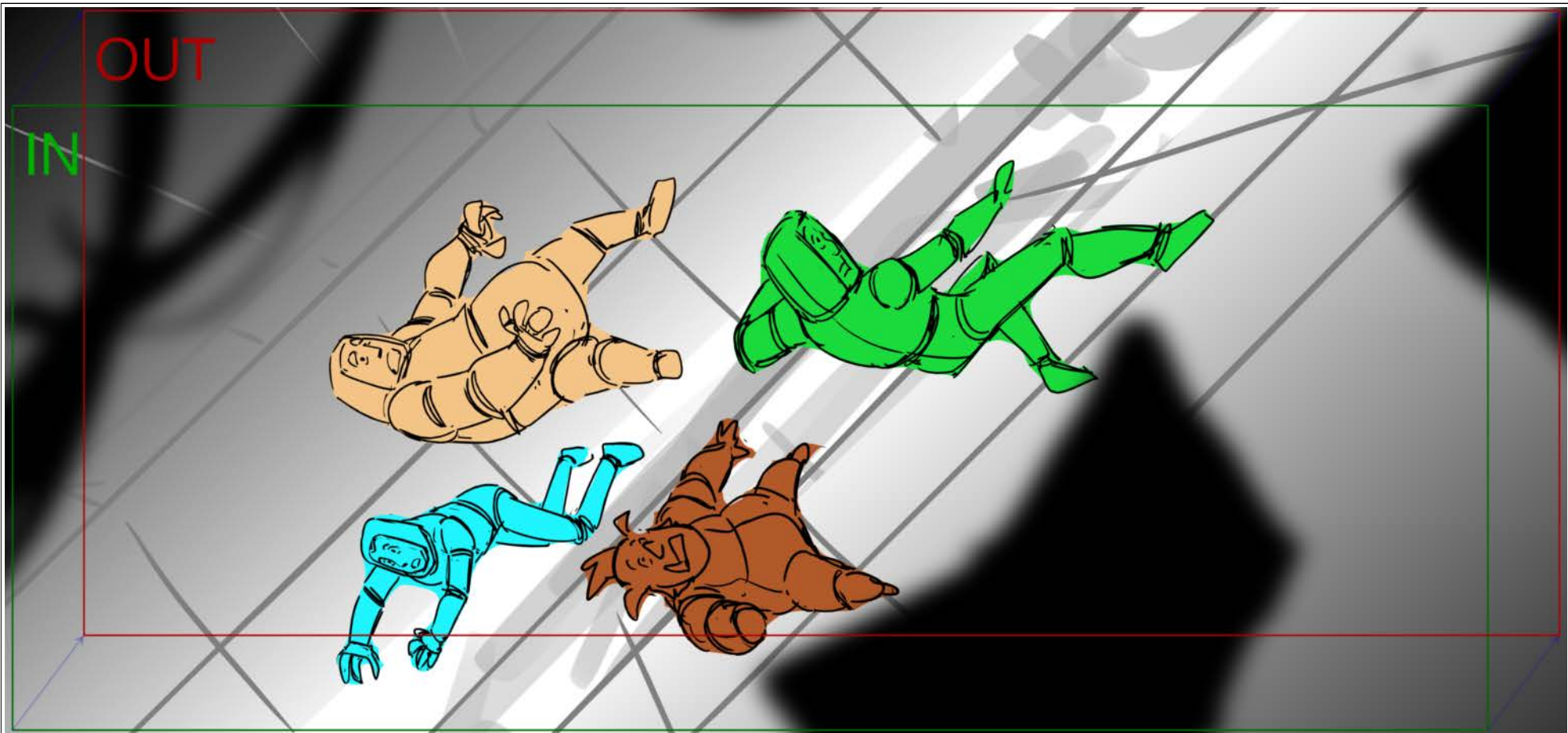

Scene	Duration	Panel	Duration
480	01:00	002	00:13

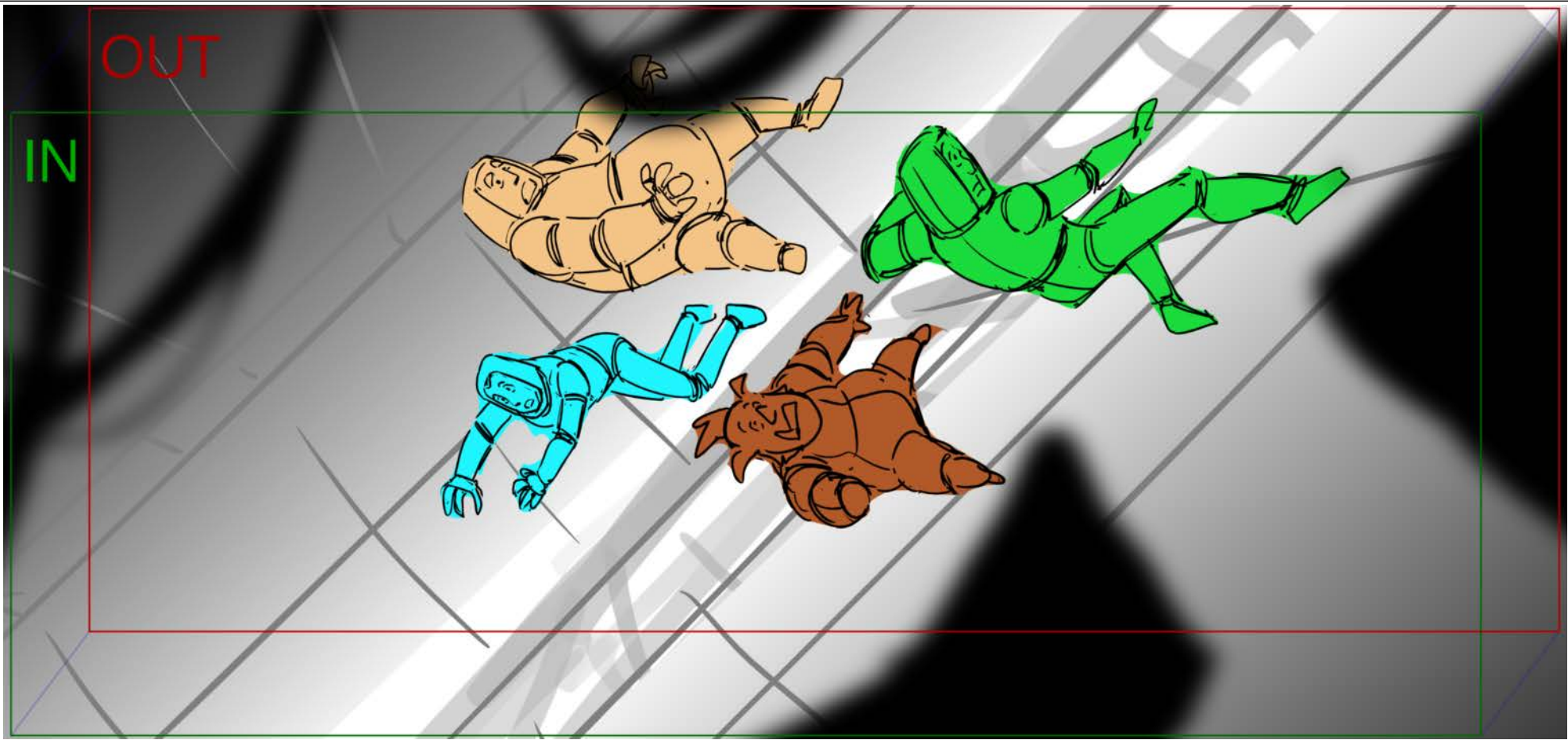

Scene	Duration	Panel	Duration
490	01:20	001	00:08

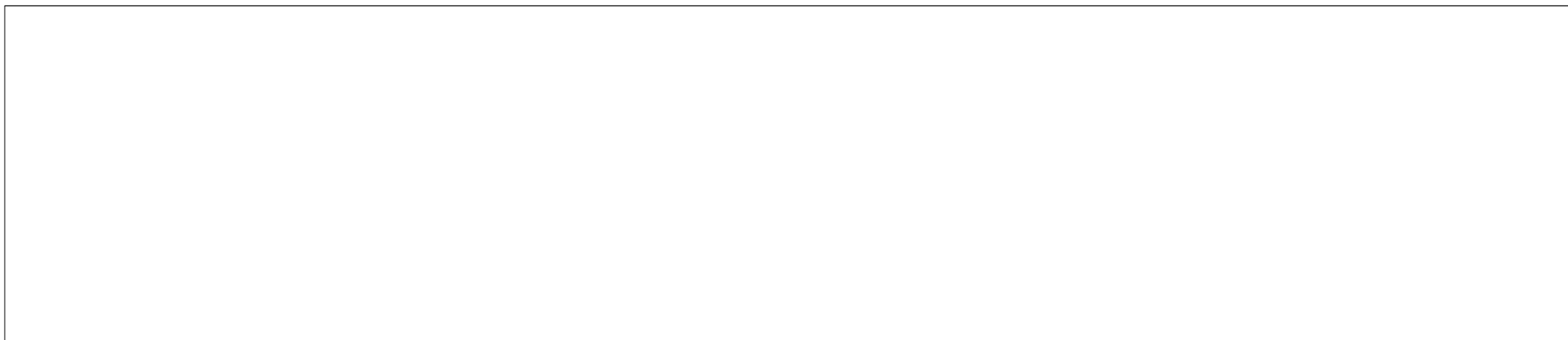
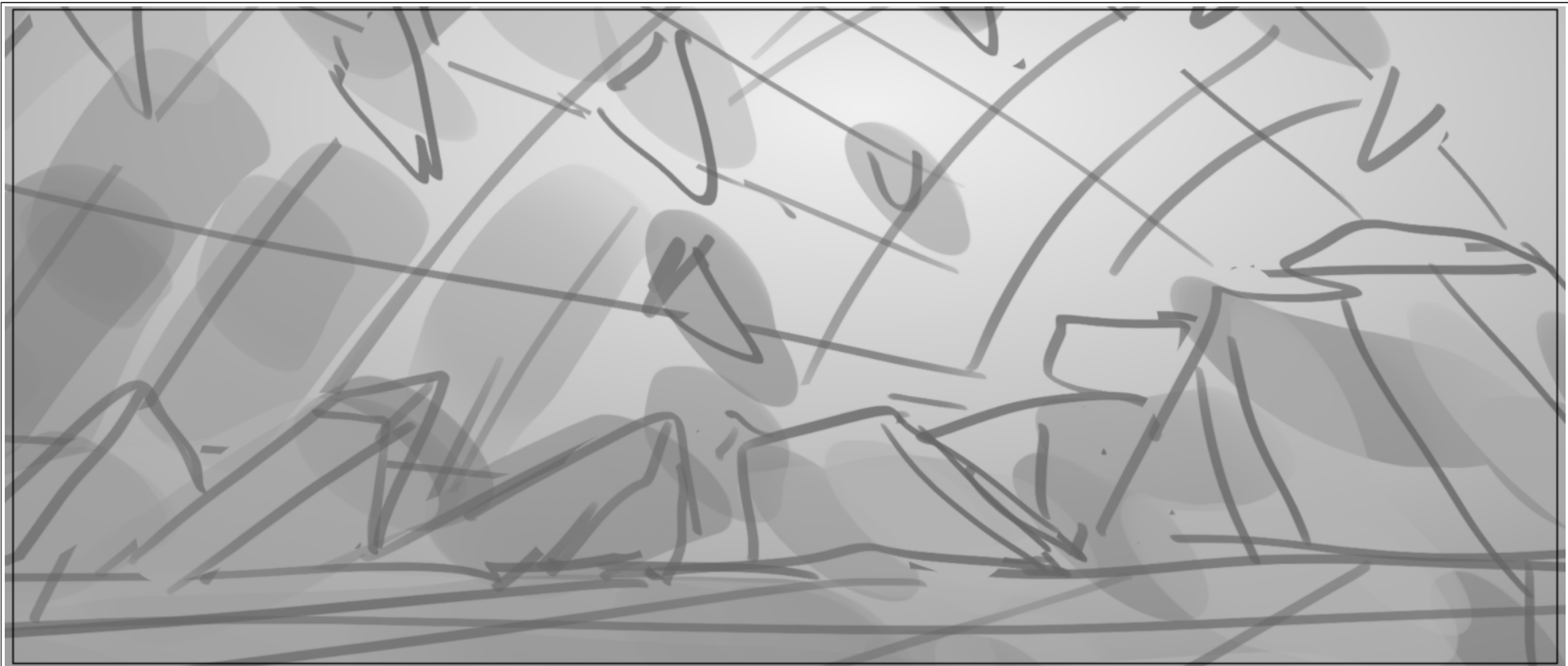

Scene	Duration	Panel	Duration
490	01:20	001A	00:11

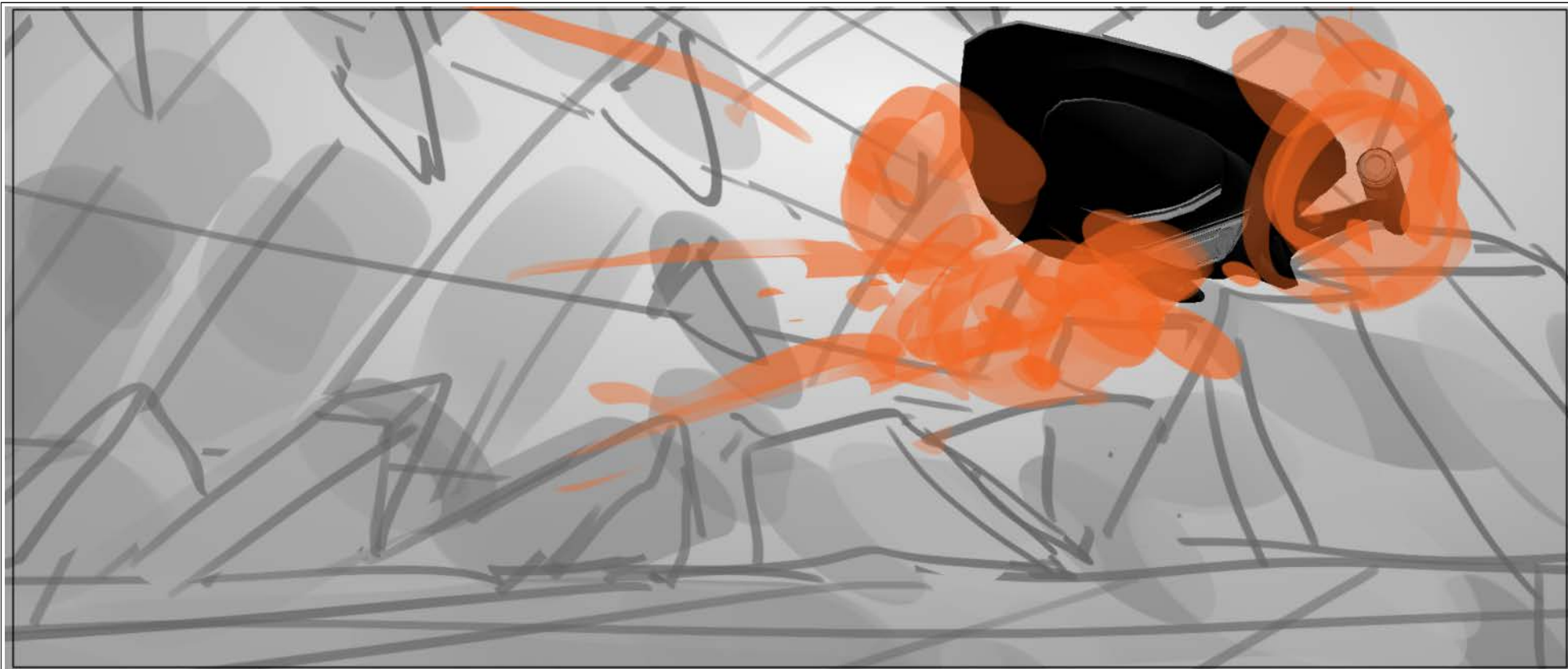

Action Notes

PROTOSTAR BURSTS THROUGH

Scene	Duration	Panel	Duration
490	01:20	001B	00:12

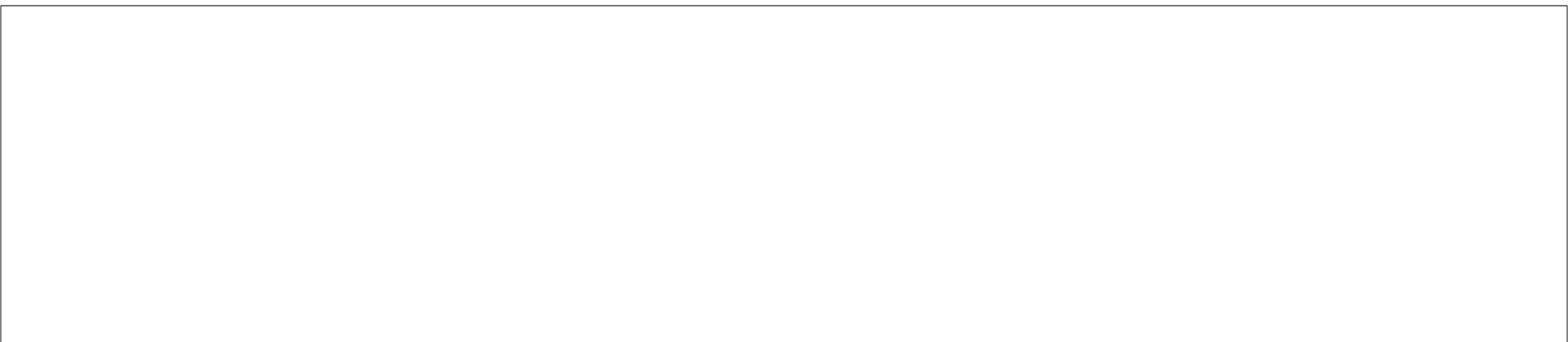
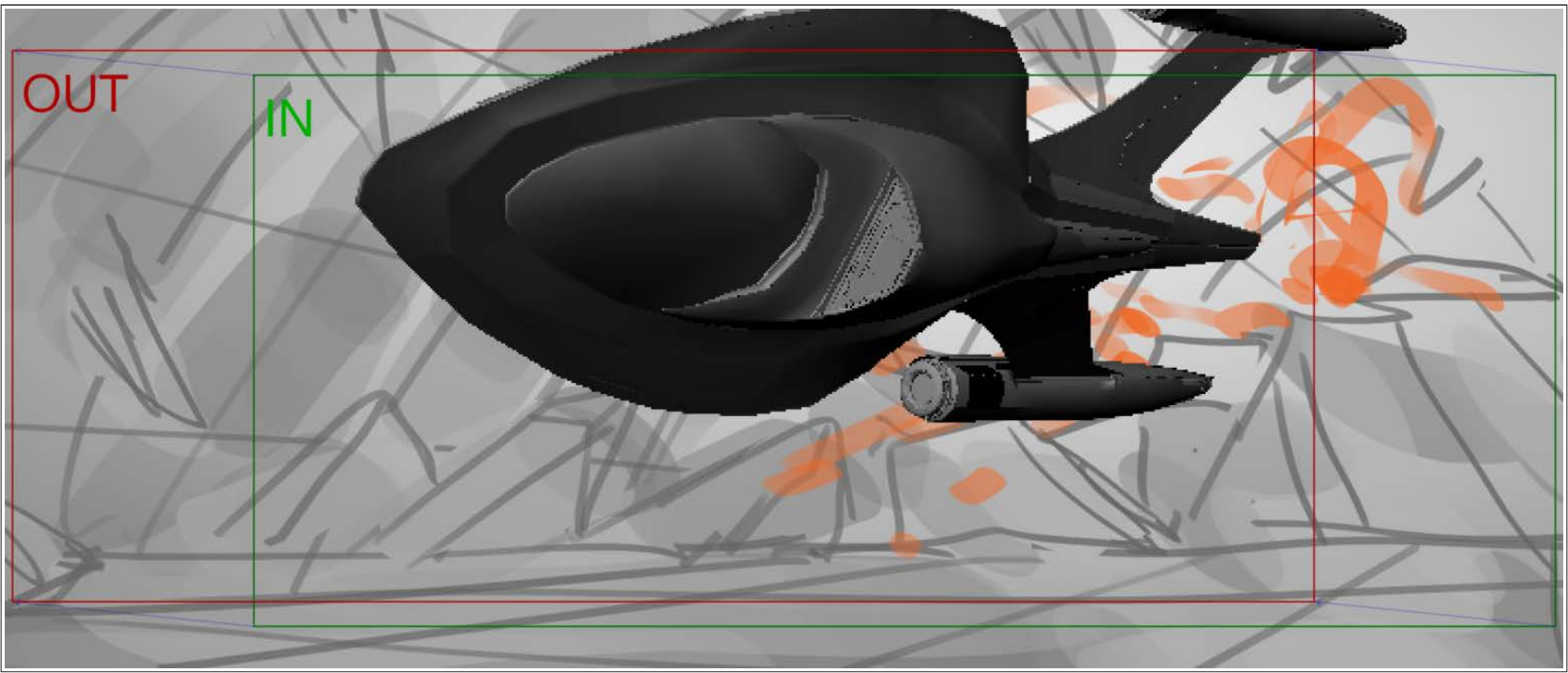

Scene	Duration	Panel	Duration
490	01:20	001C	00:07

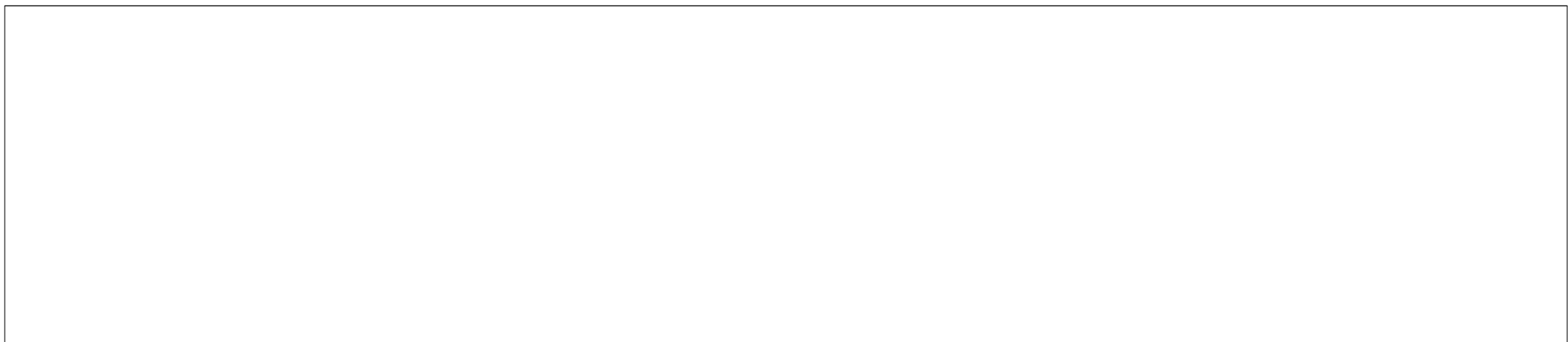
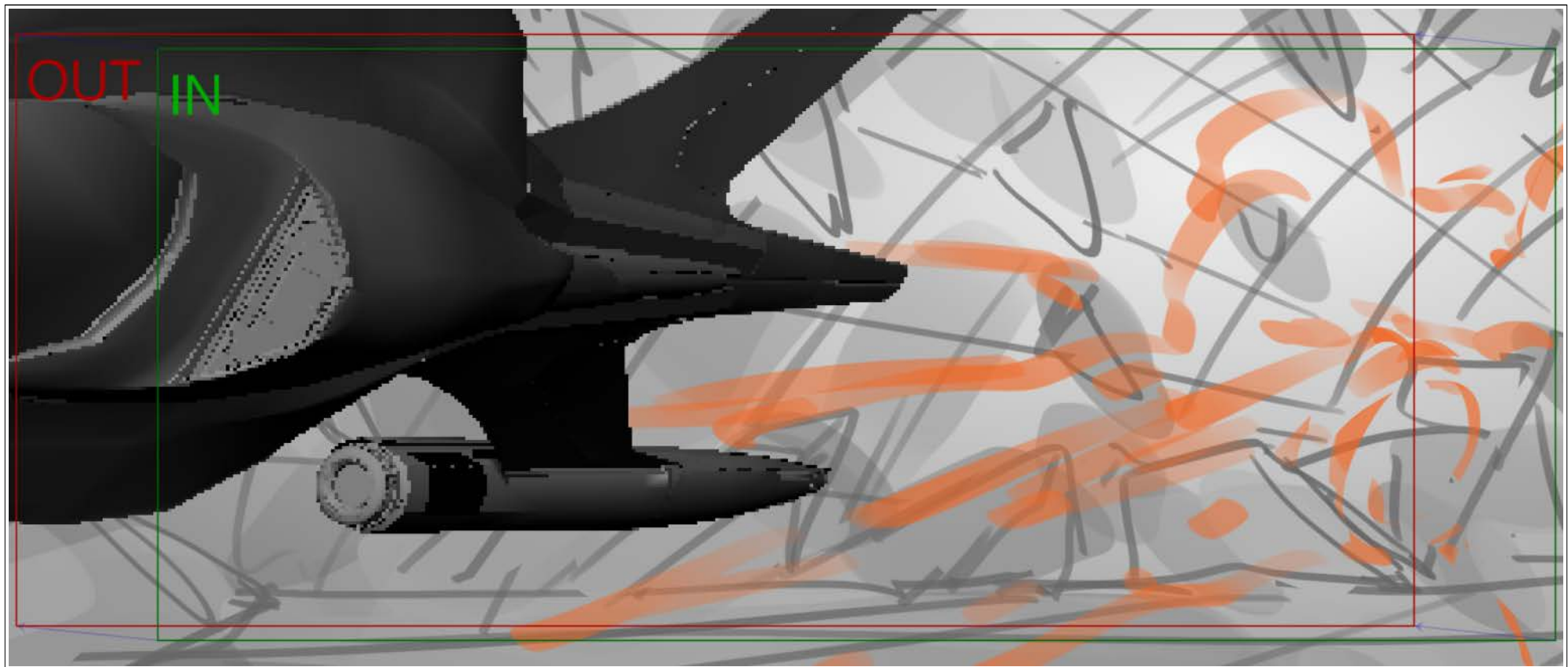

Scene	Duration	Panel	Duration
490	01:20	02C	00:06

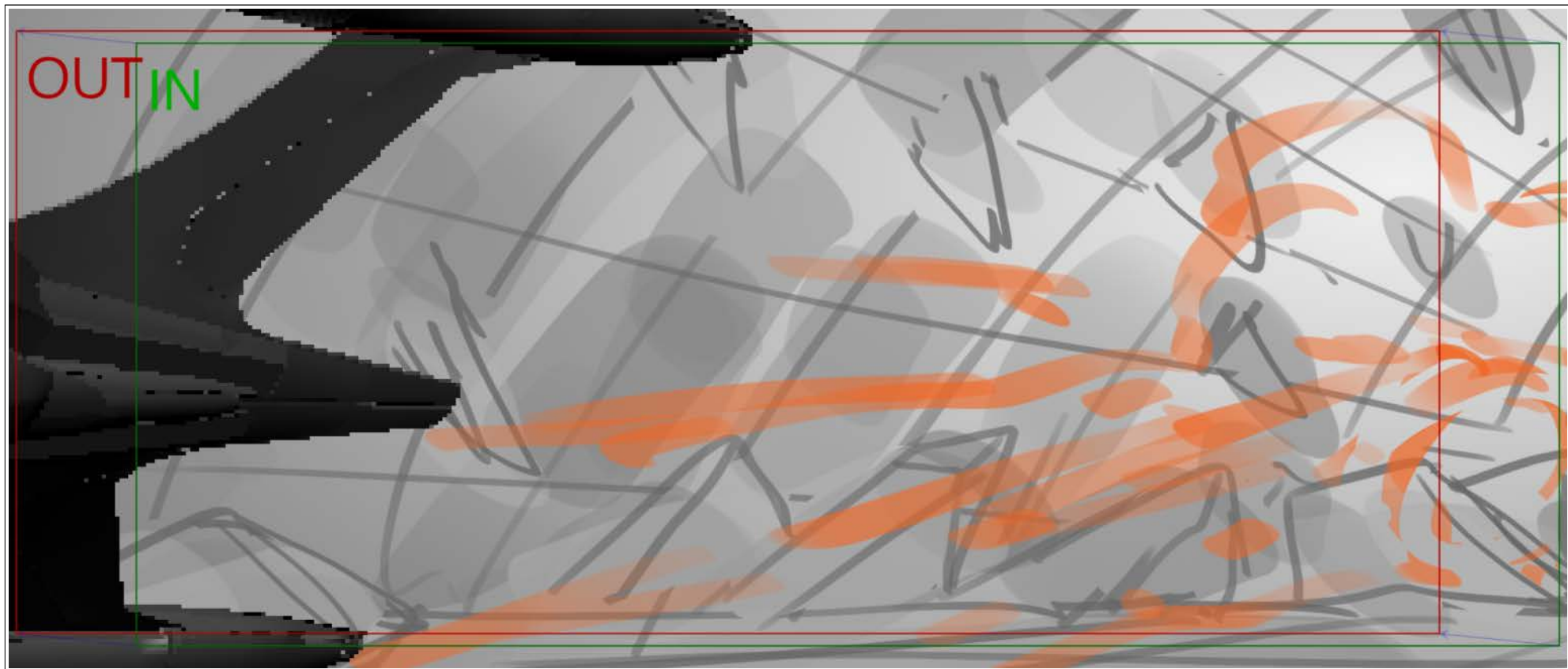

Scene	Duration	Panel	Duration
500	01:00	001	01:00

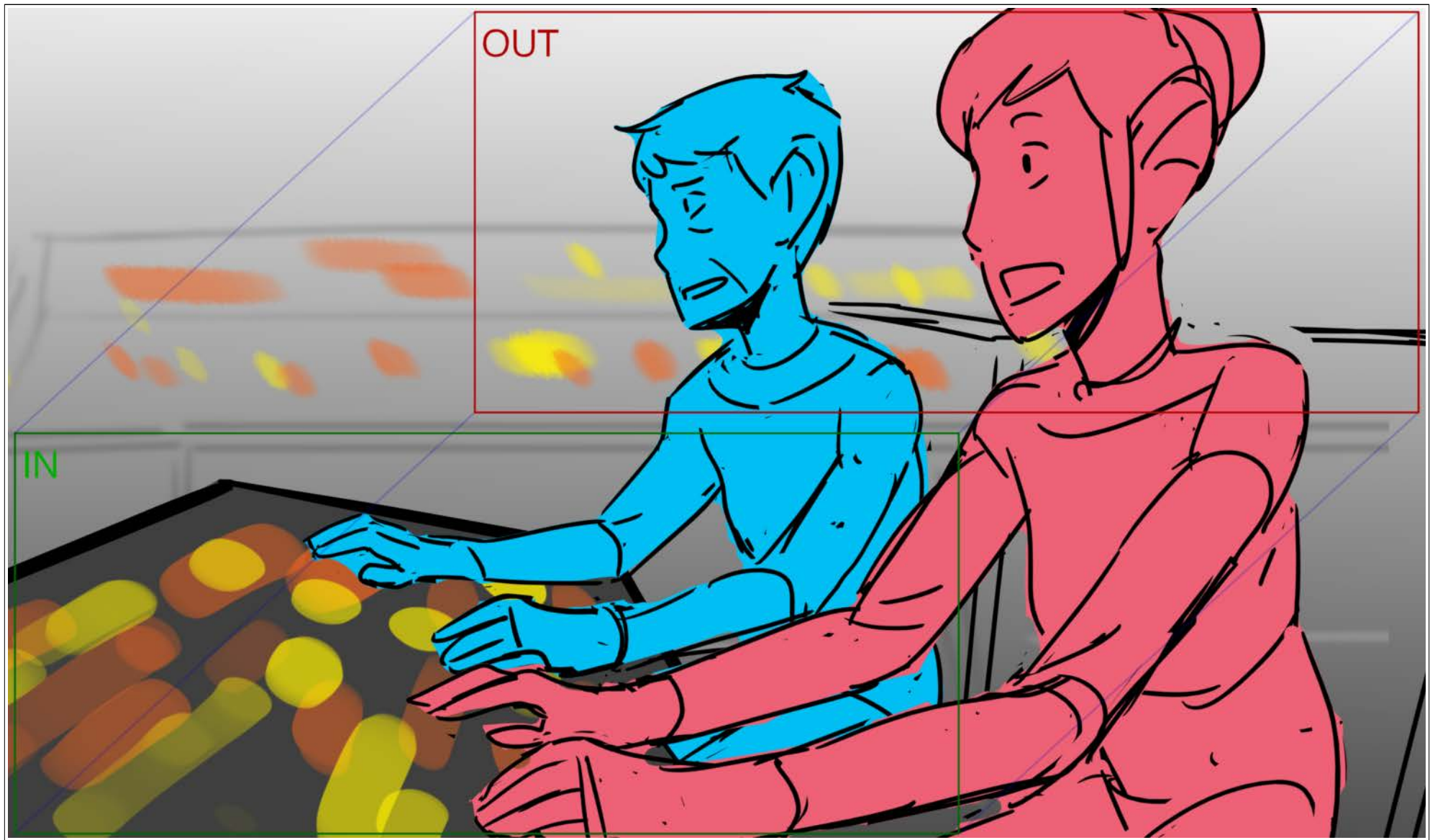

Scene	Duration	Panel	Duration
510	01:12	002A	00:03

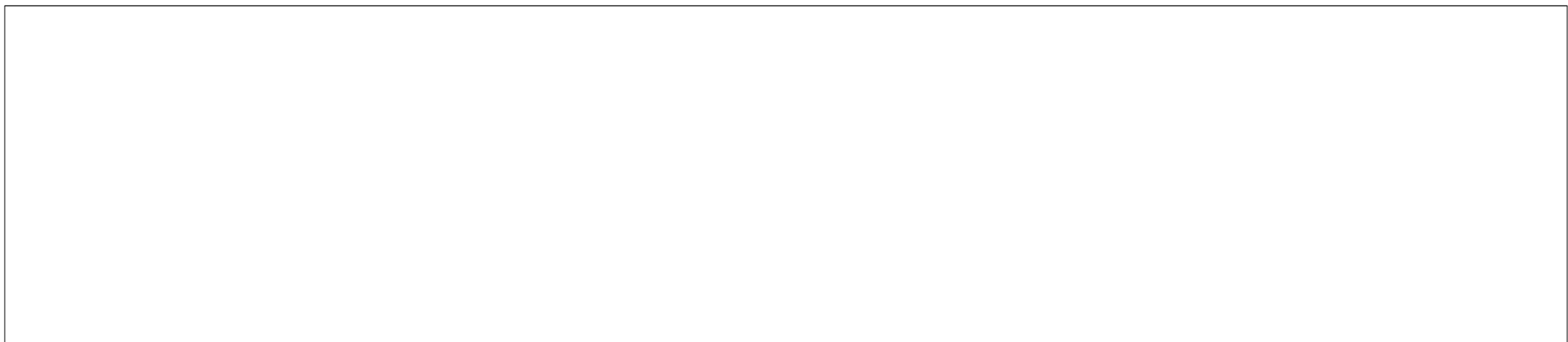
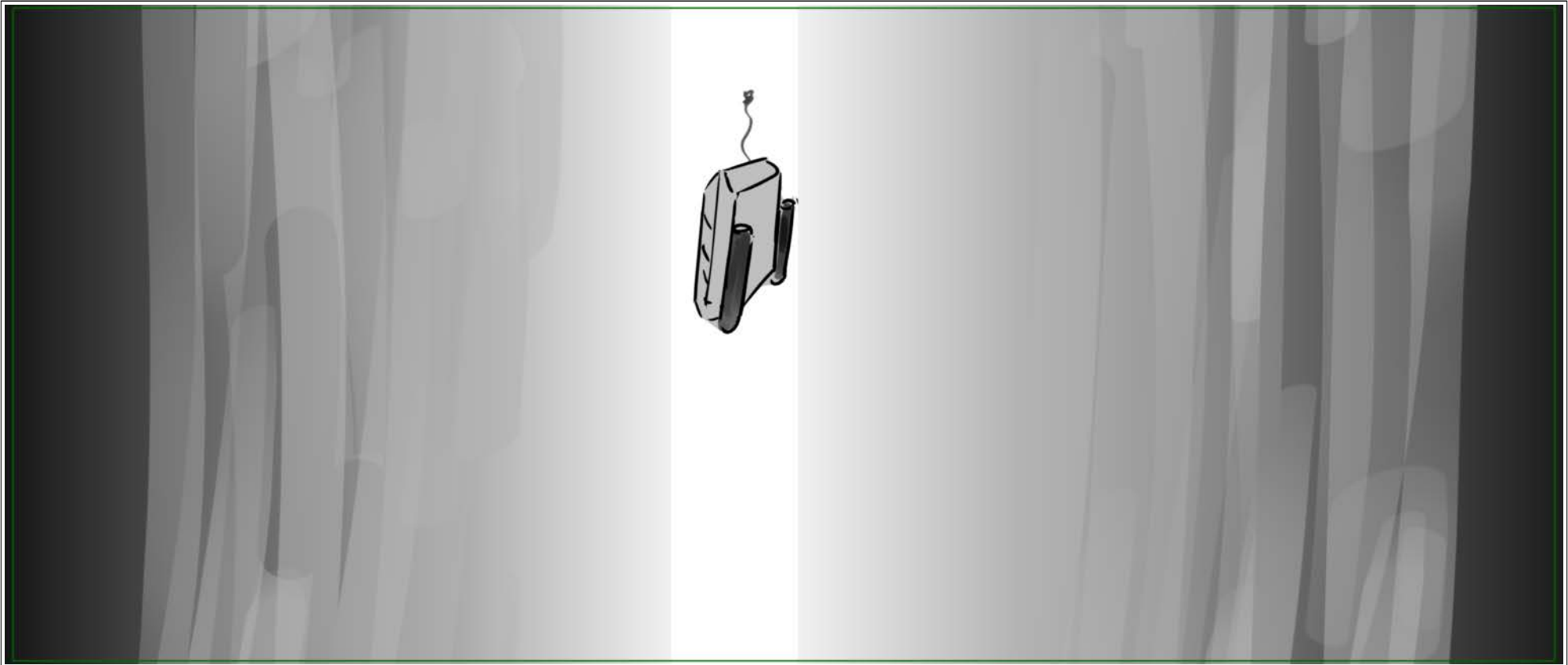

Scene	Duration	Panel	Duration
510	01:12	002A0	00:03

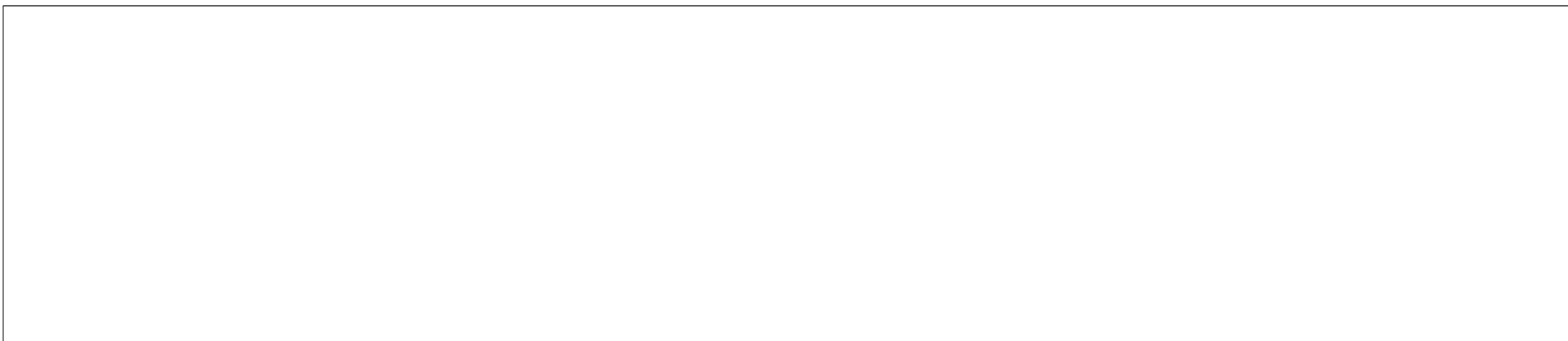
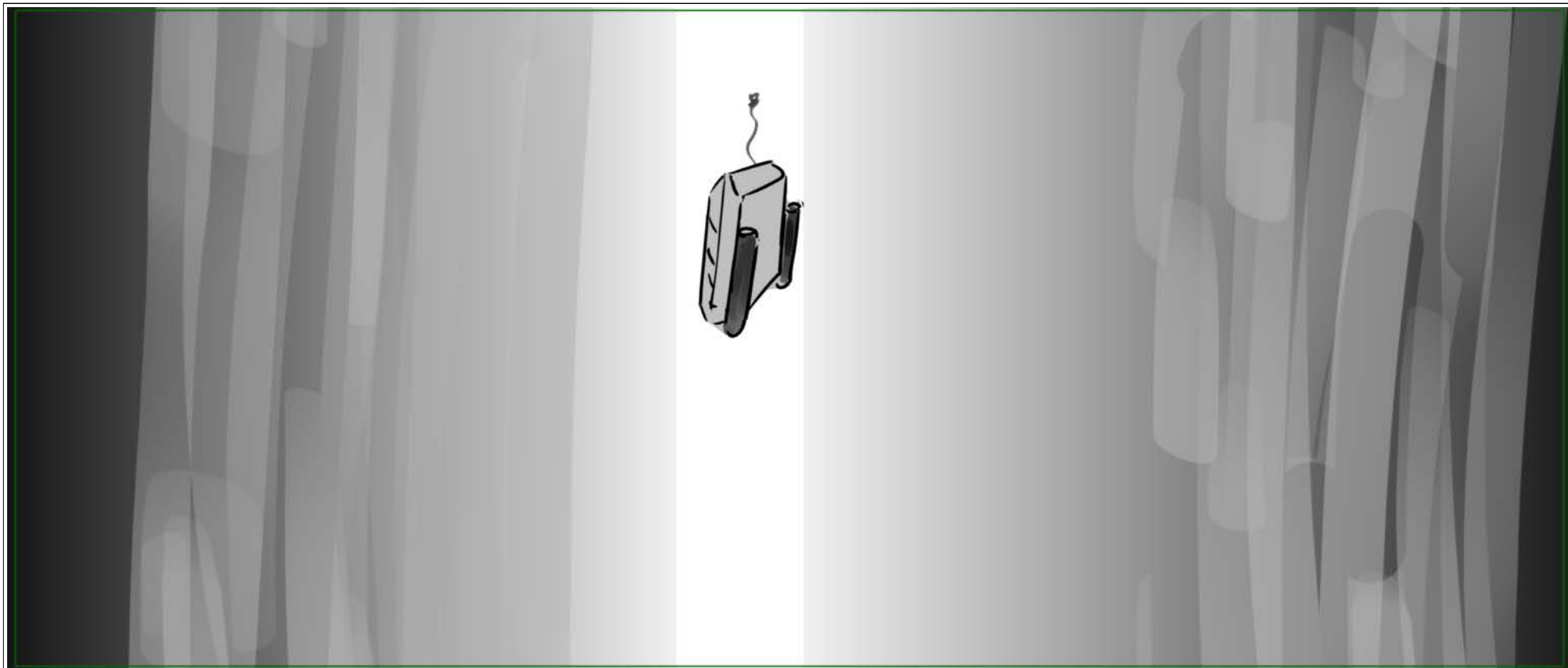

Scene	Duration	Panel	Duration
510	01:12	002B	00:03

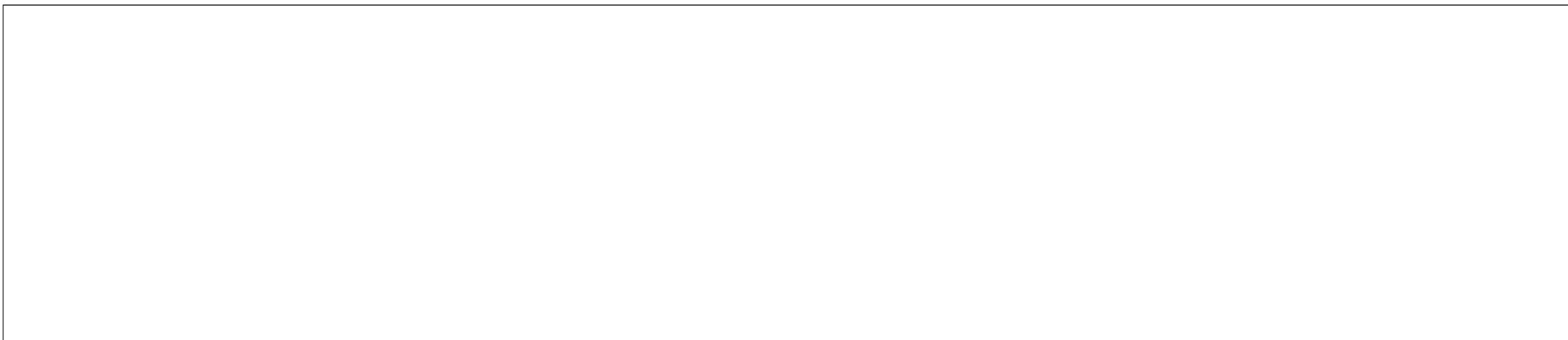
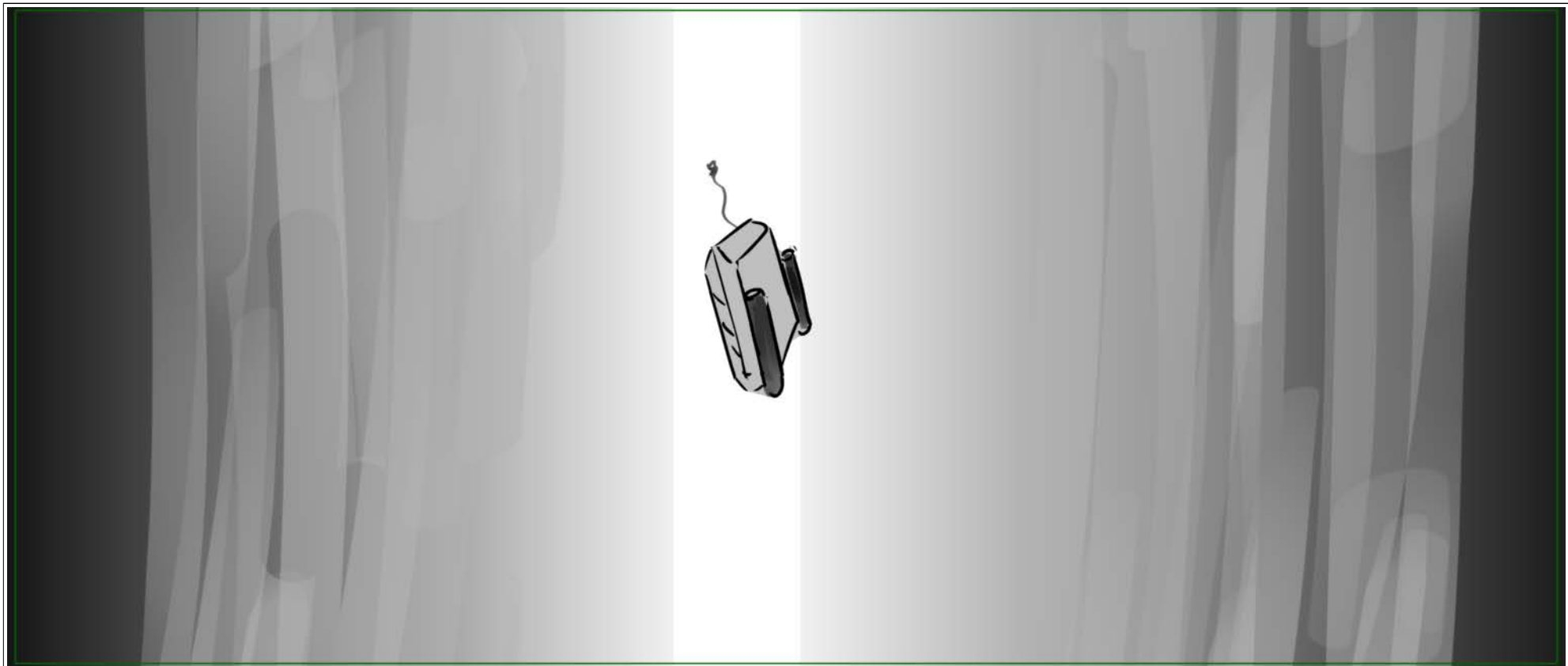

Scene	Duration	Panel	Duration
510	01:12	002A1	00:03

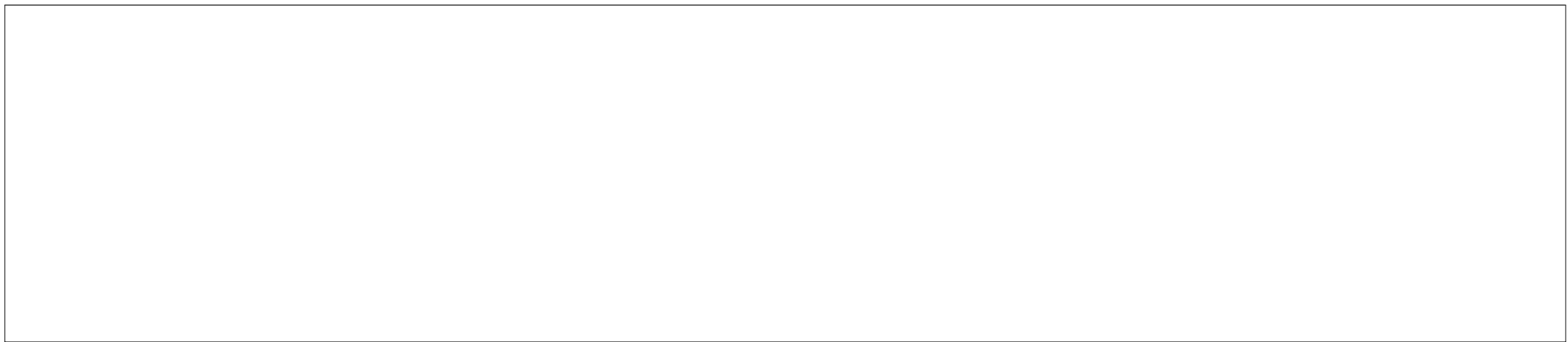
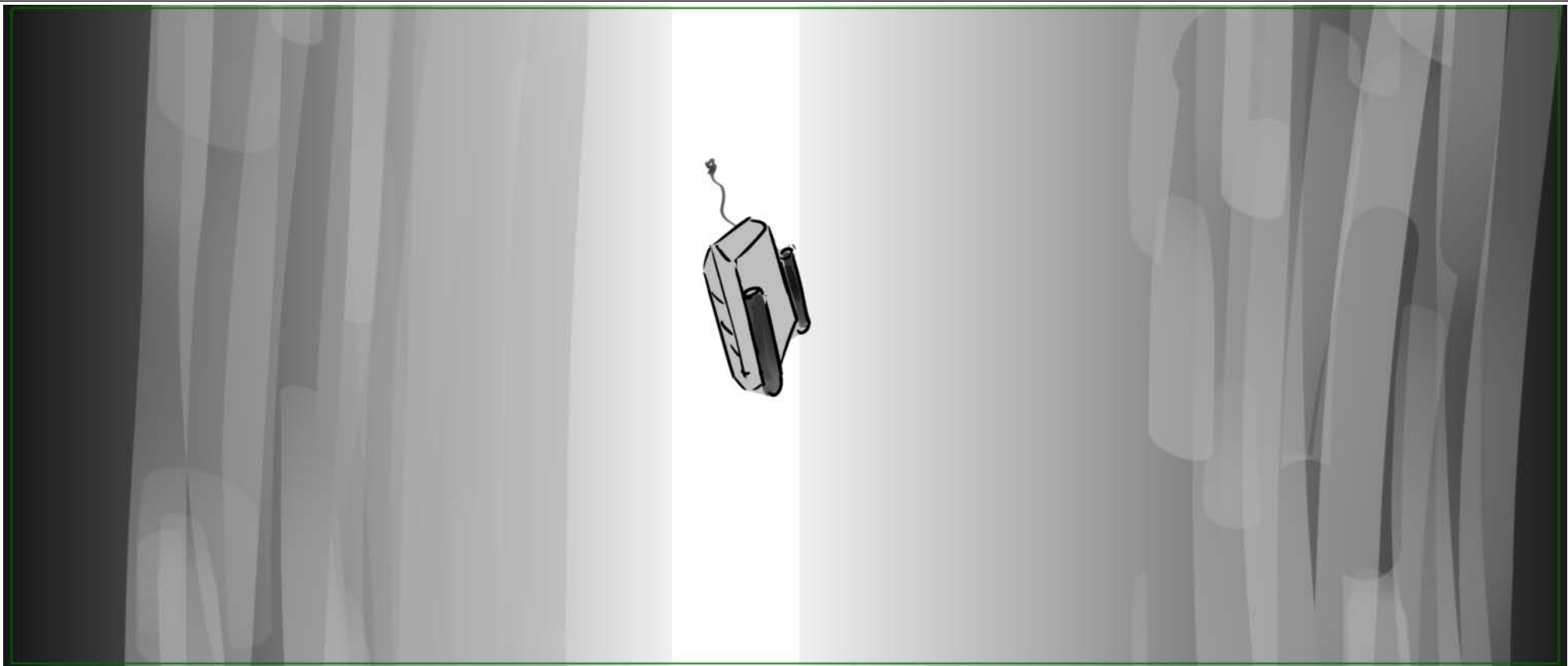

Scene	Duration	Panel	Duration
510	01:12	002C	00:03

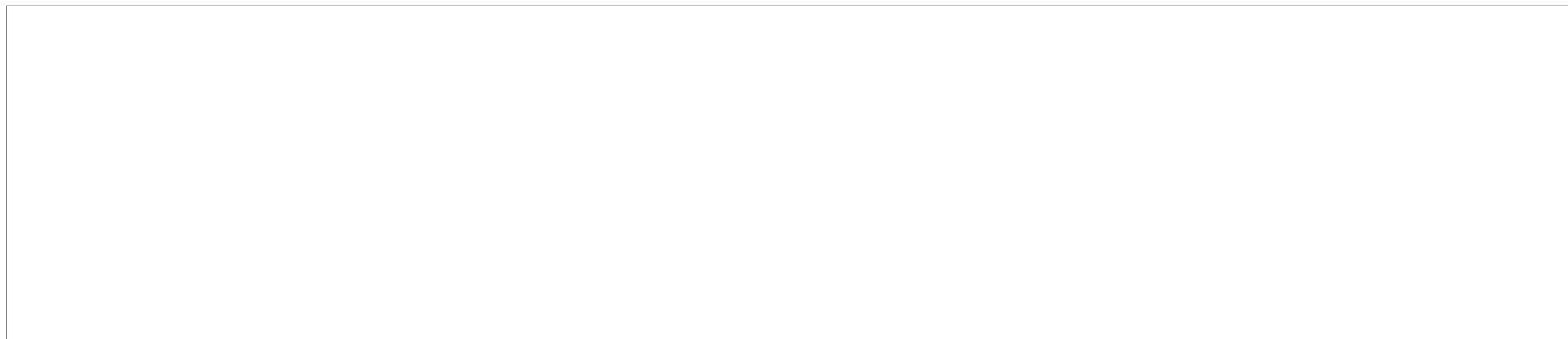
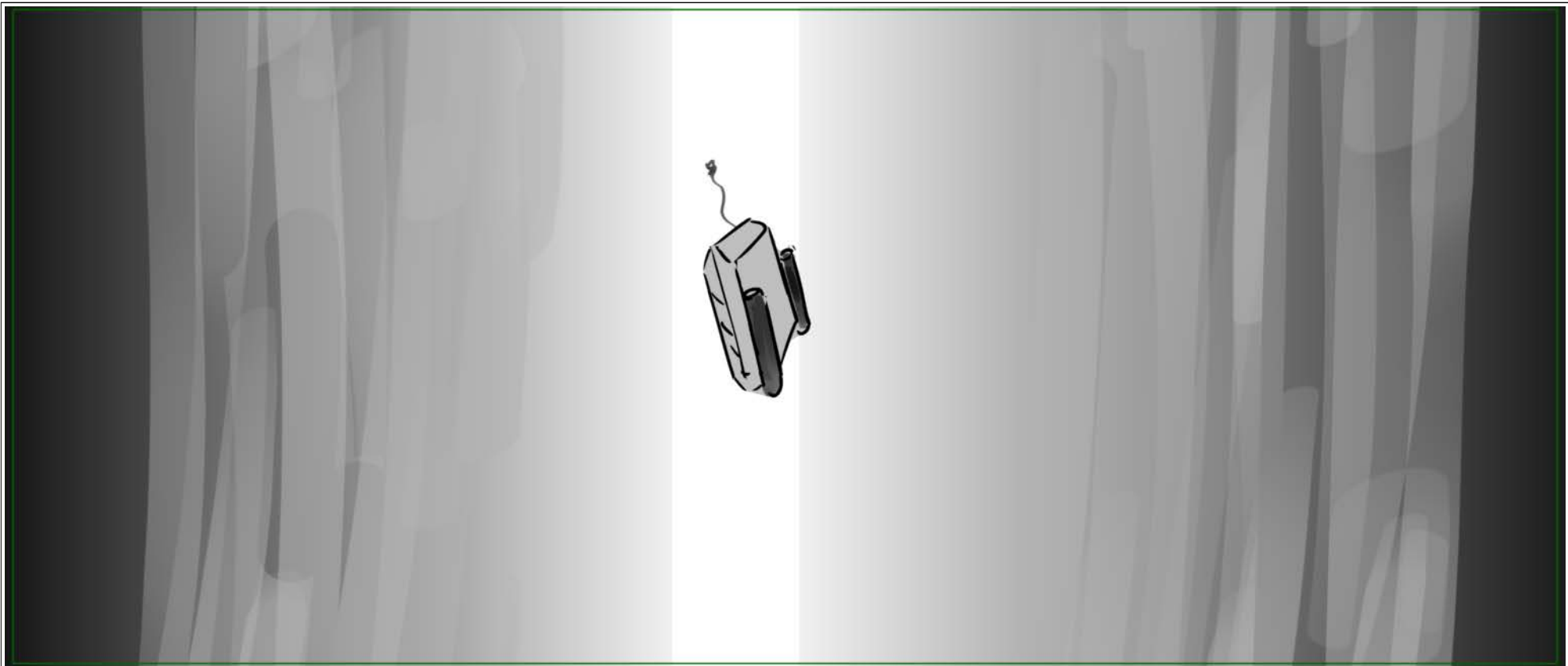

Scene	Duration	Panel	Duration
510	01:12	001A	00:03

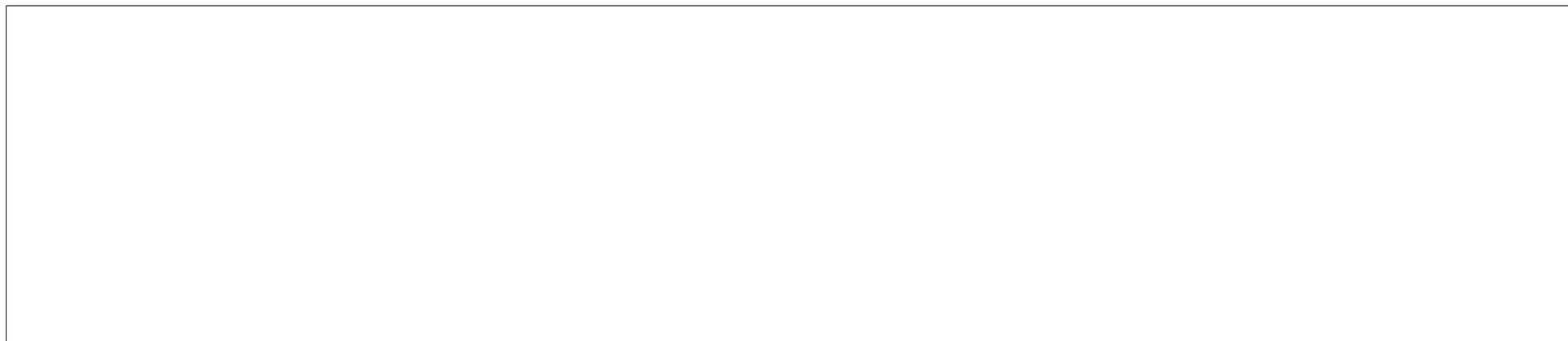
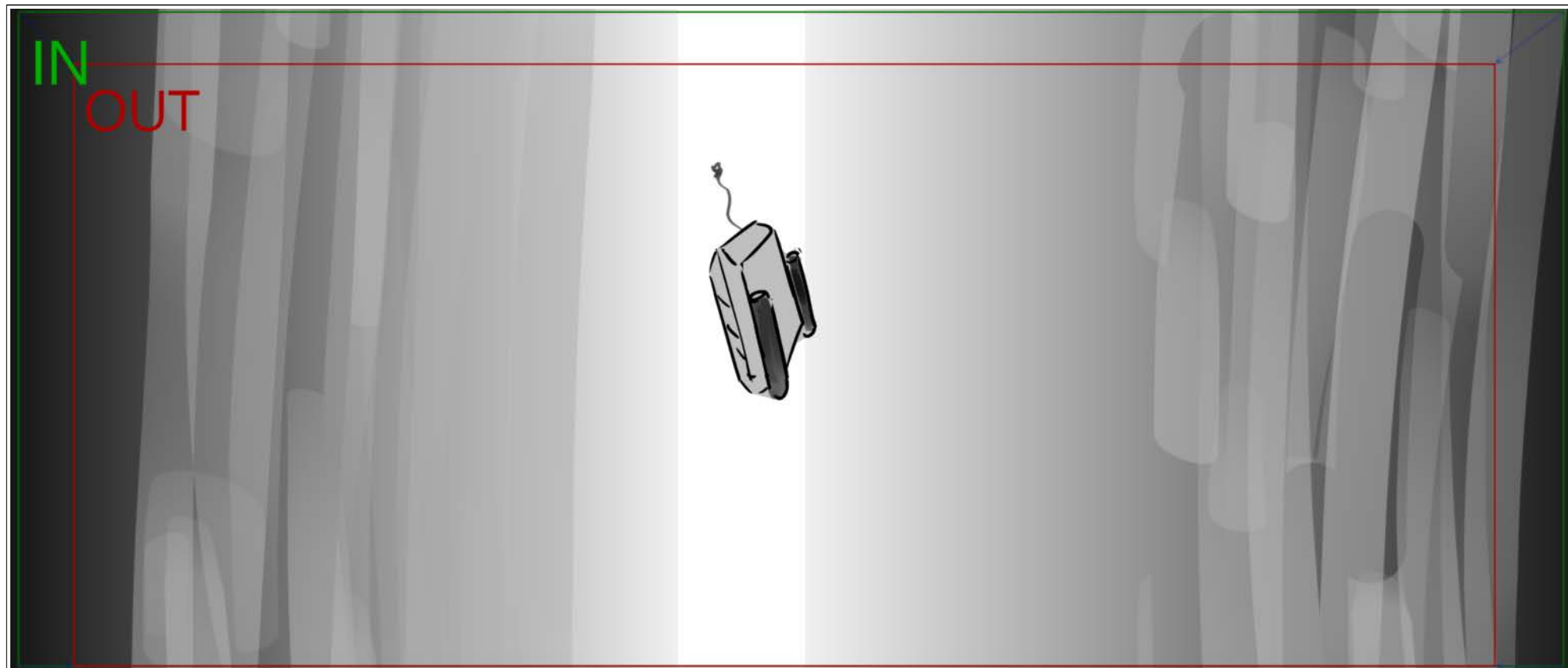

Scene	510	Duration	01:12	Panel	001C	Duration	00:03
-------	-----	----------	-------	-------	------	----------	-------

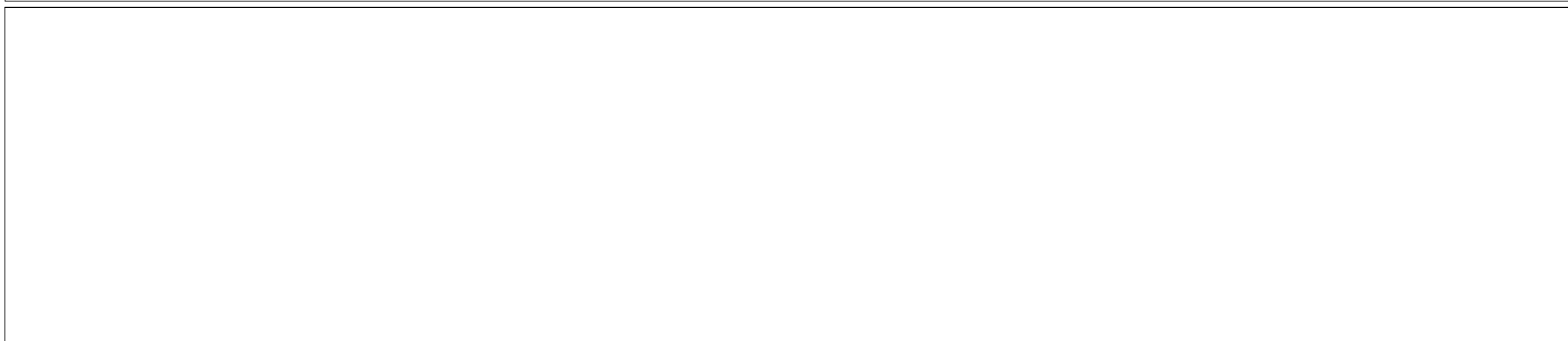
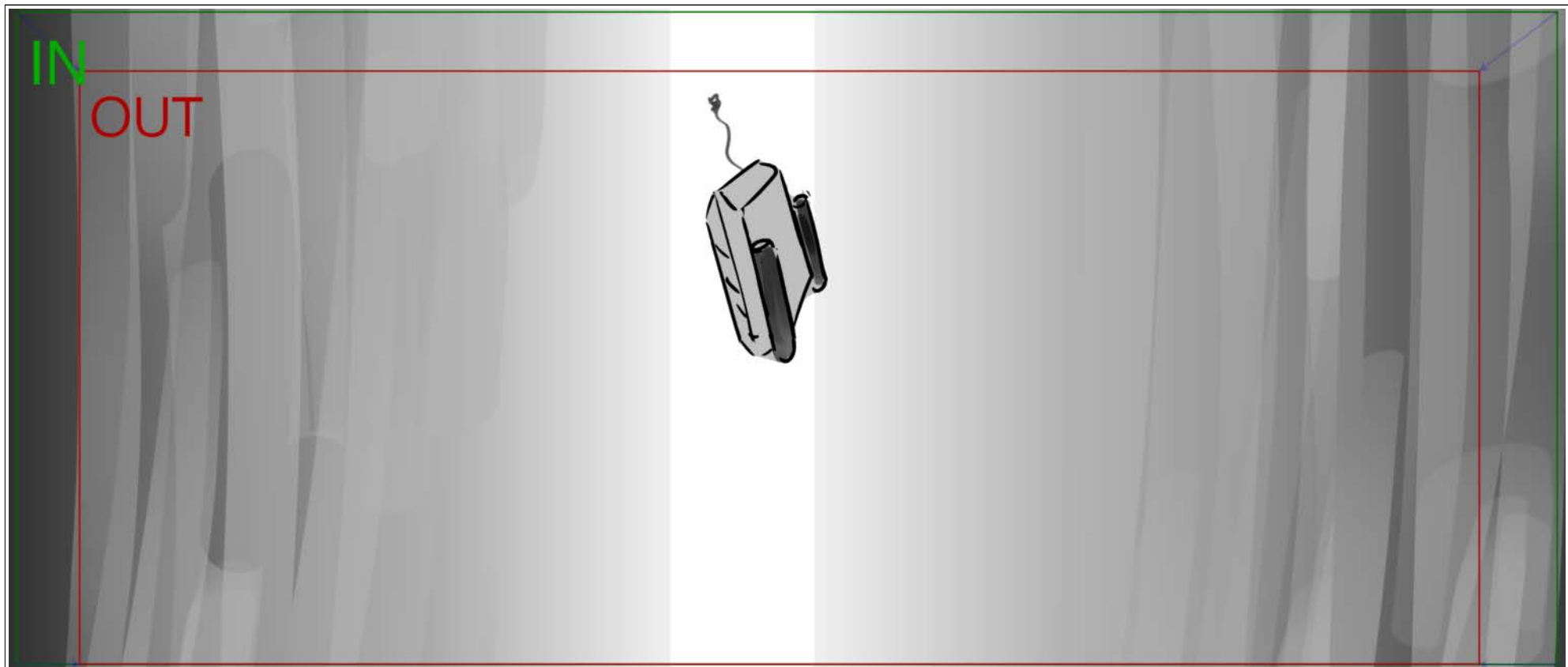

Scene	Duration	Panel	Duration
510	01:12	001B	00:03

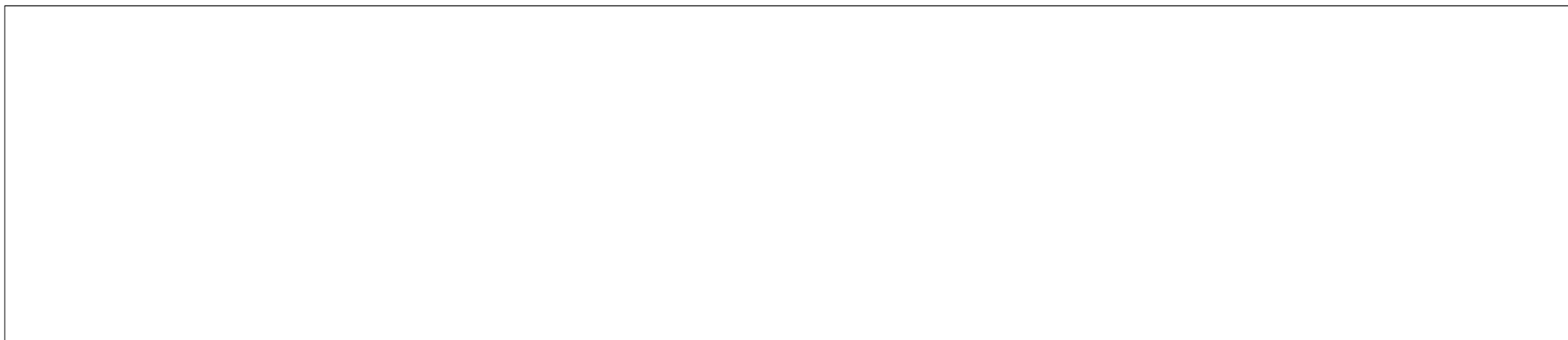
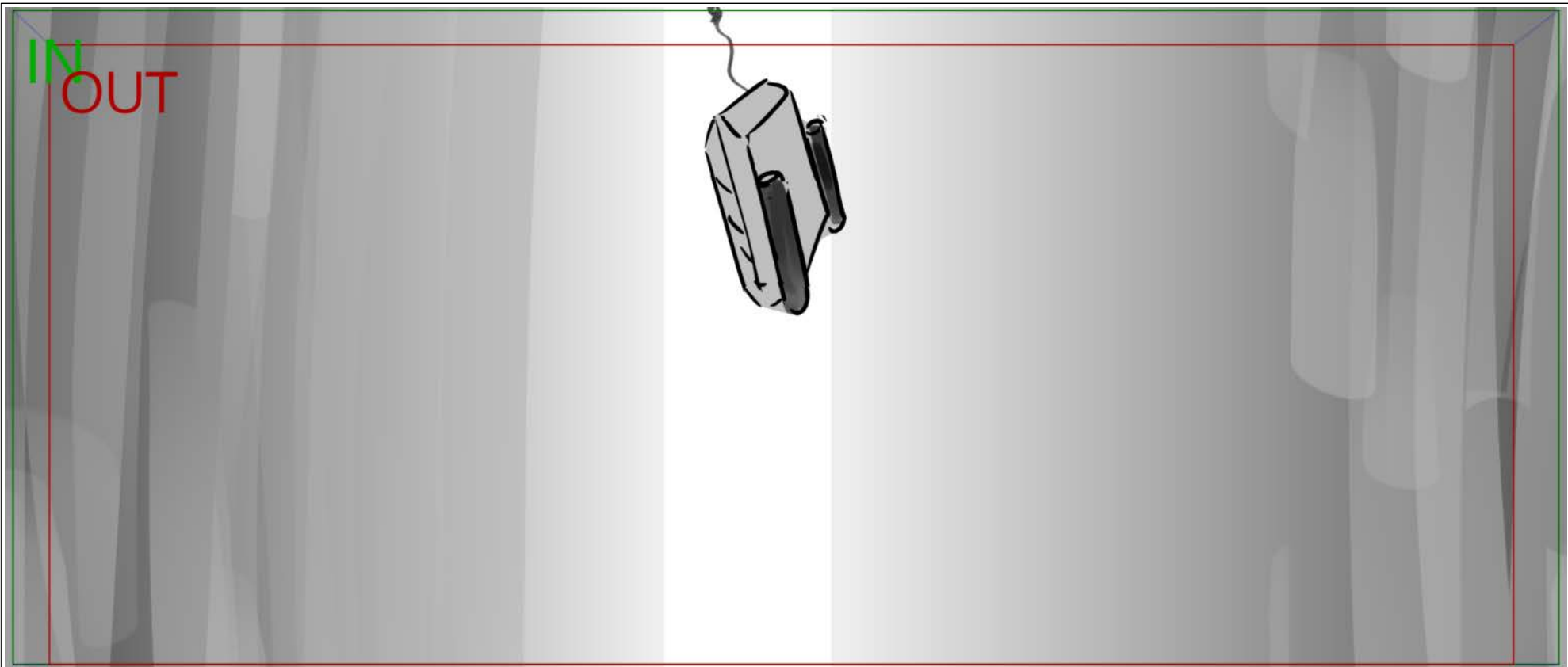

Scene	Duration	Panel	Duration
510	01:12	001D	00:03

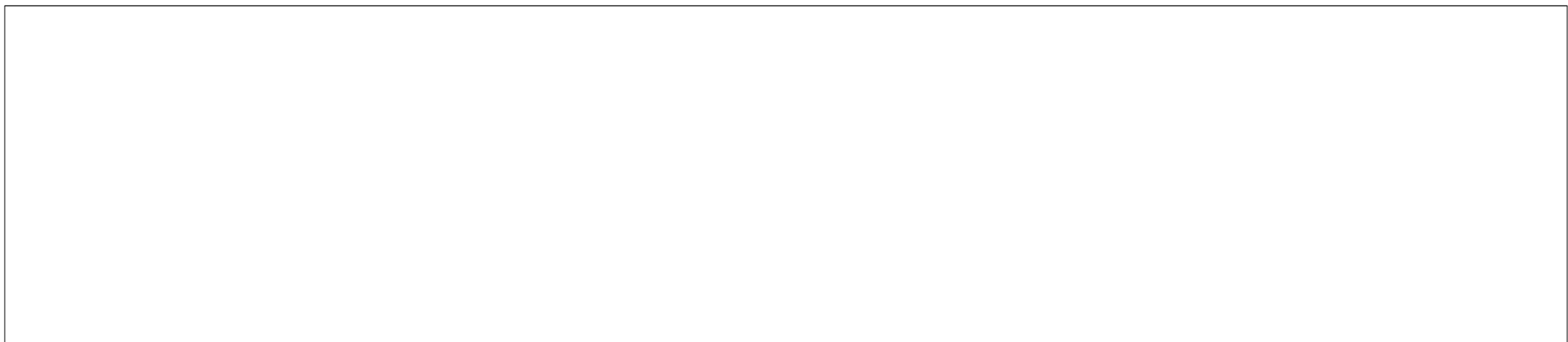
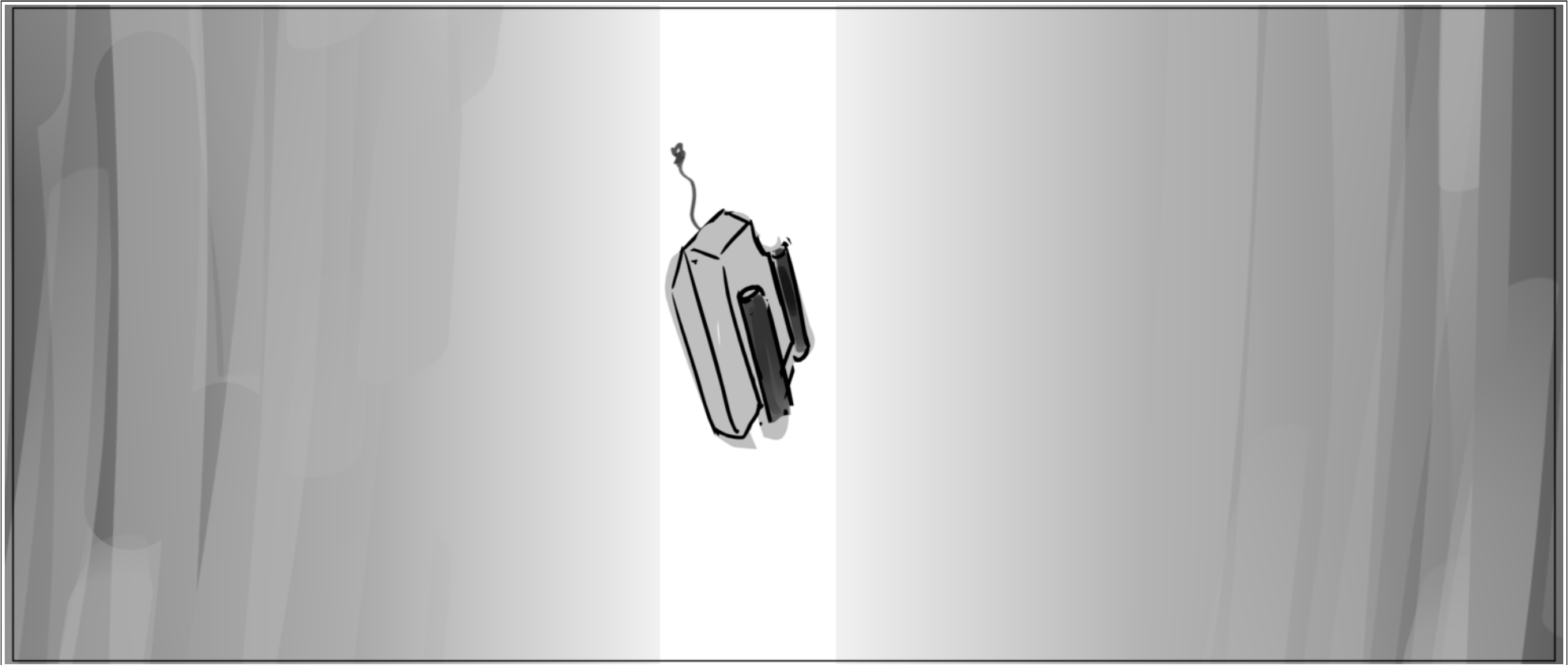

Scene	Duration	Panel	Duration
510	01:12	02A	00:03

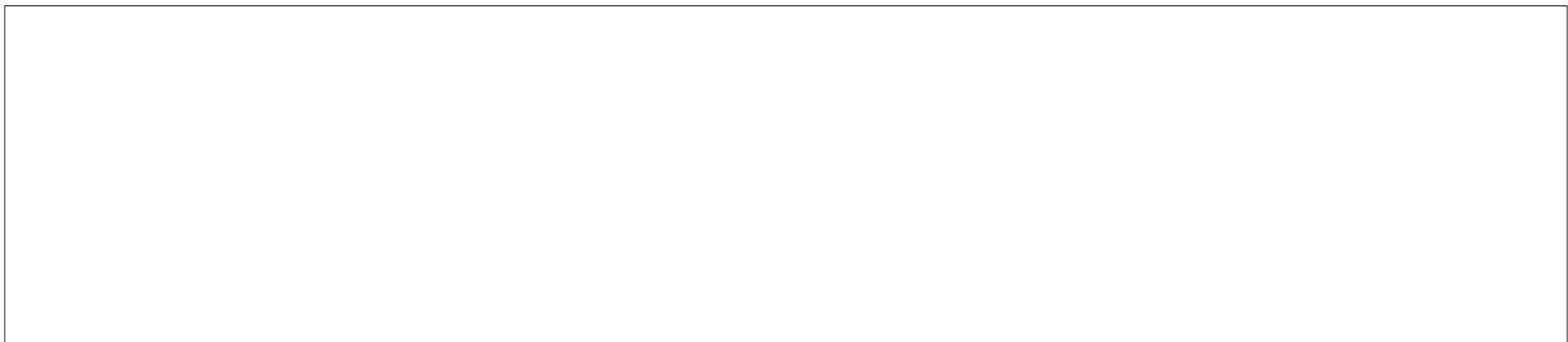
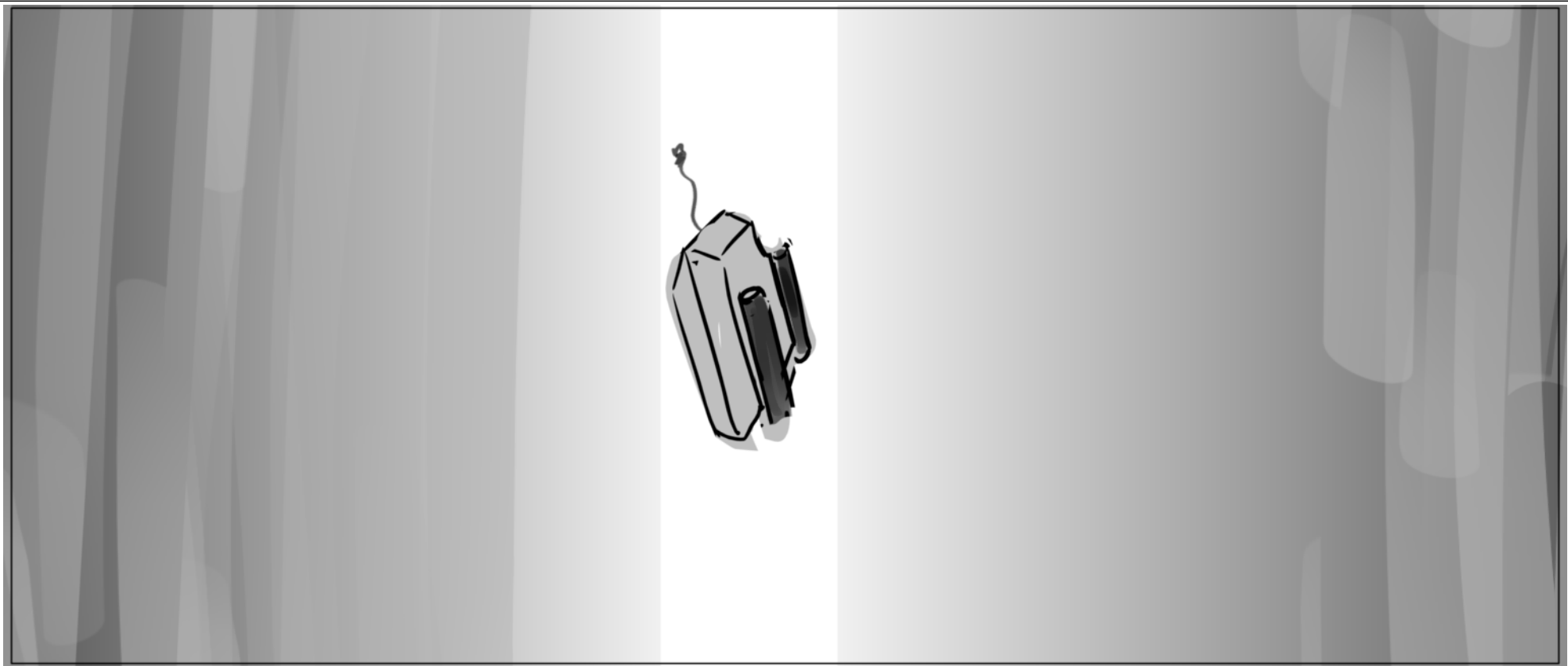

Scene	Duration	Panel	Duration
510	01:12	03A	00:03

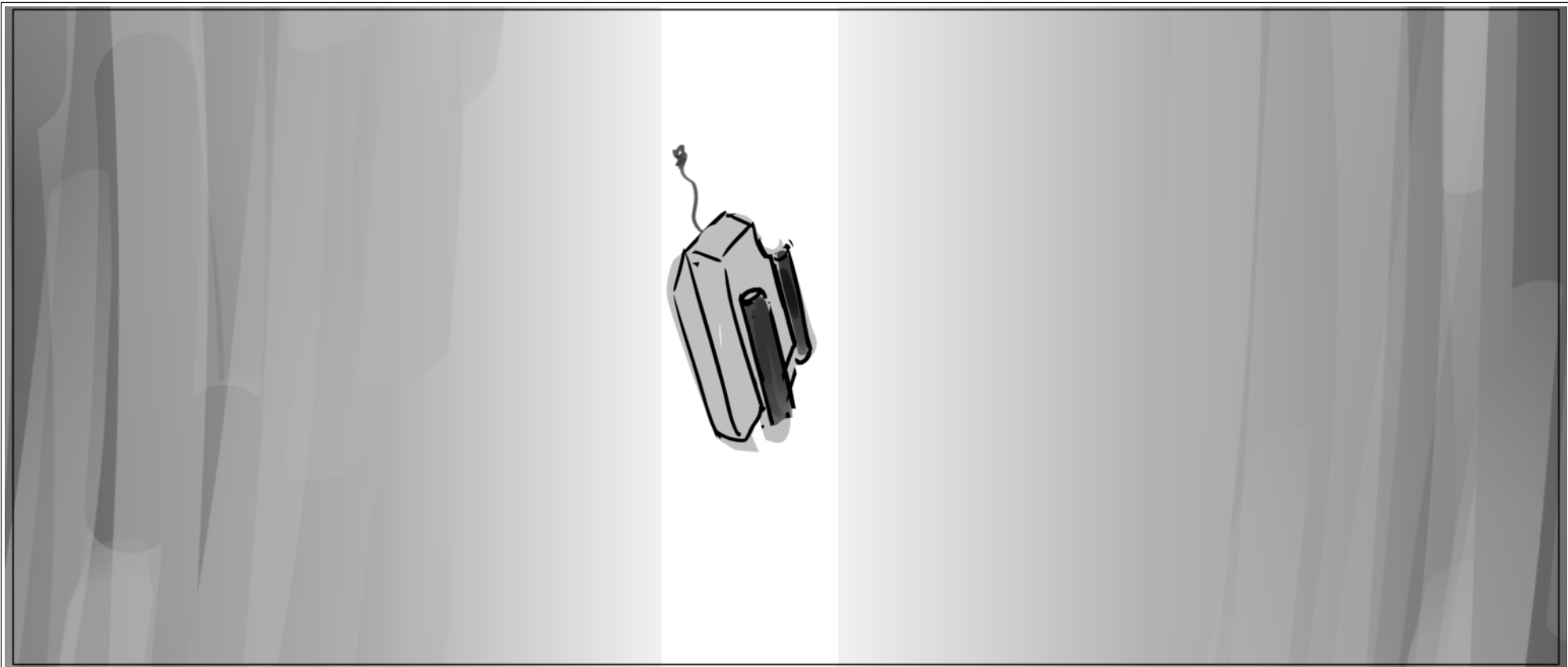

Scene	Duration	Panel	Duration
510	01:12	04A	00:03

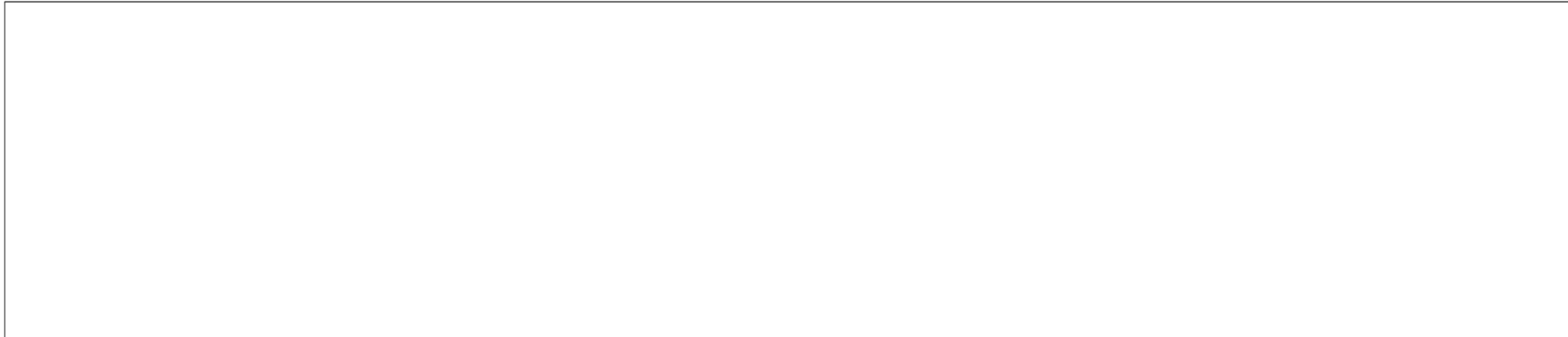
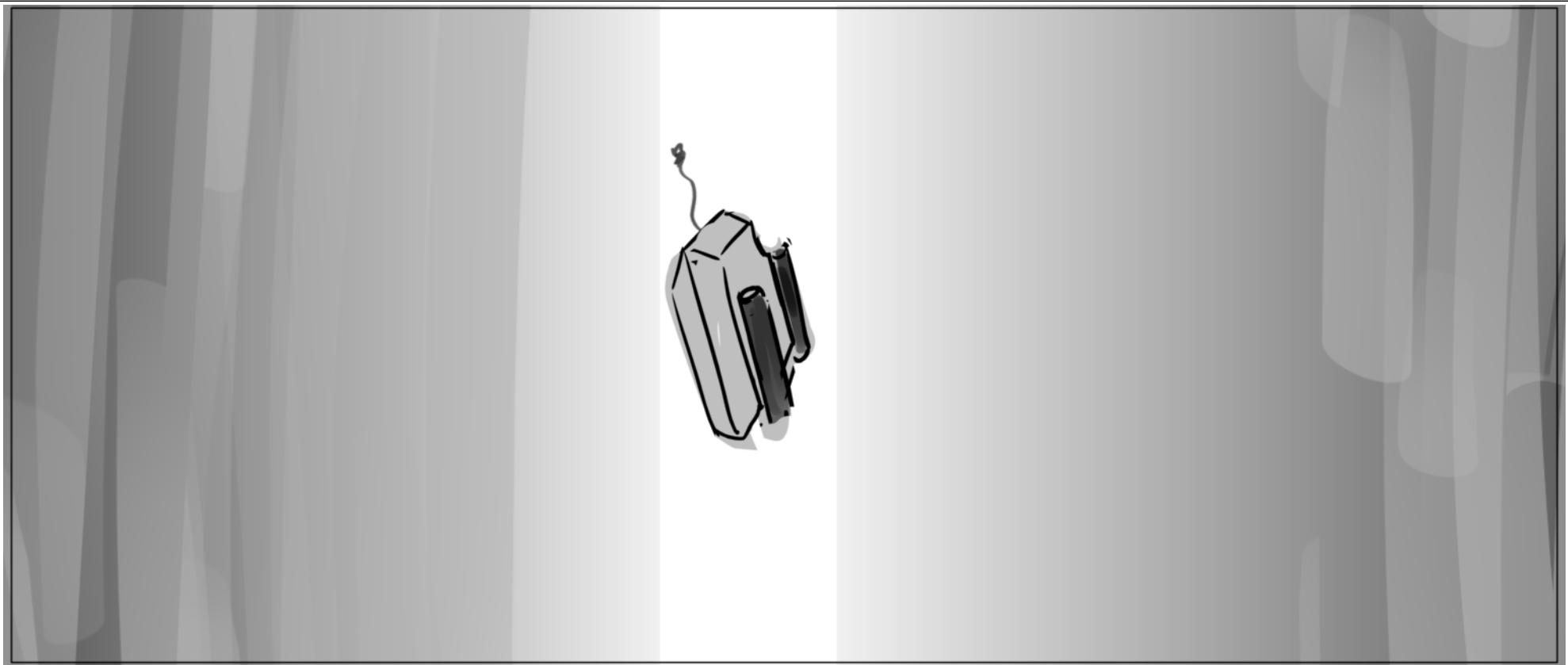

Scene	Duration	Panel	Duration
520	01:19	001	00:16

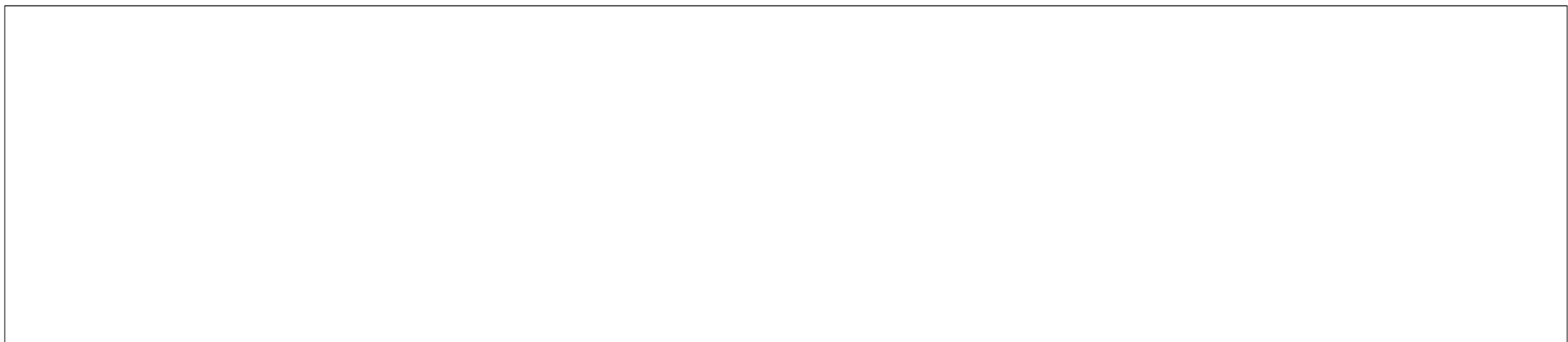
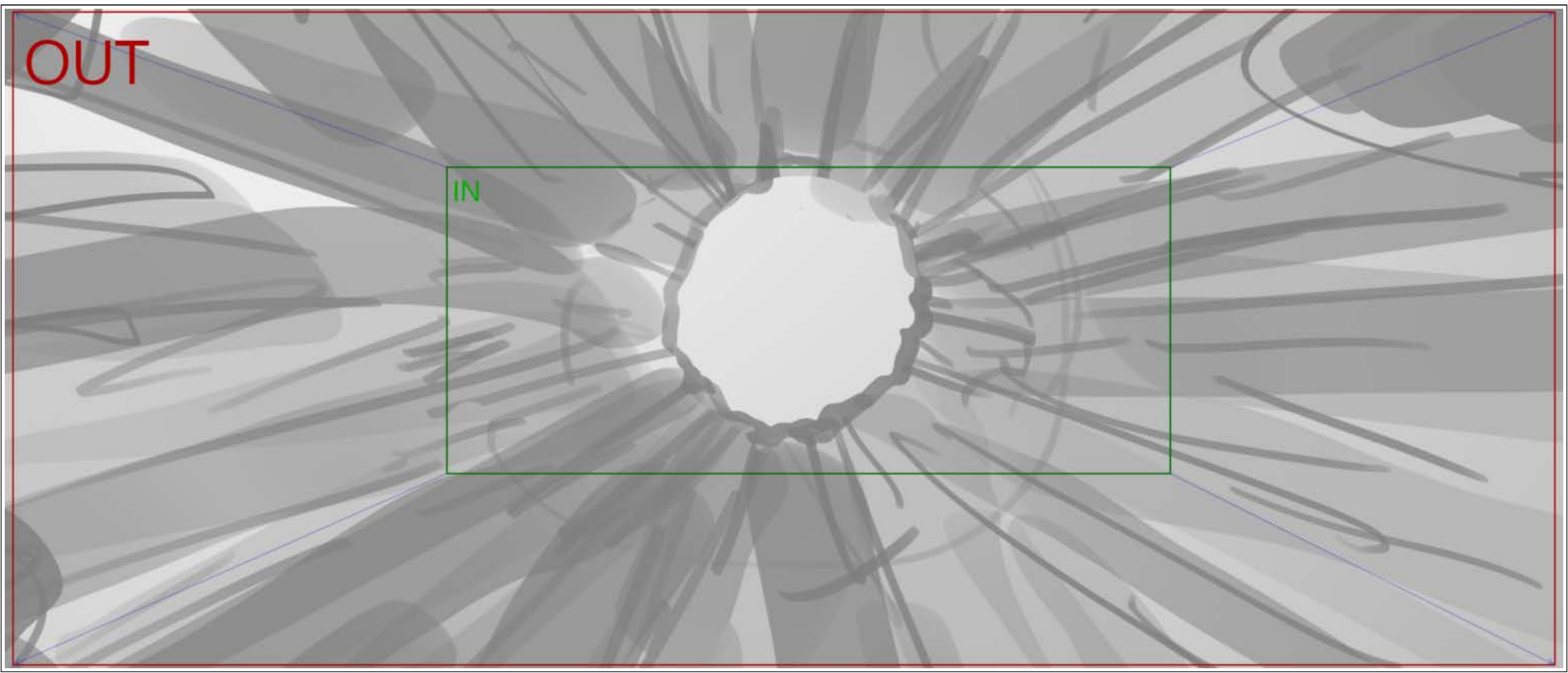

Scene	Duration	Panel	Duration
520	01:19	001A	00:07

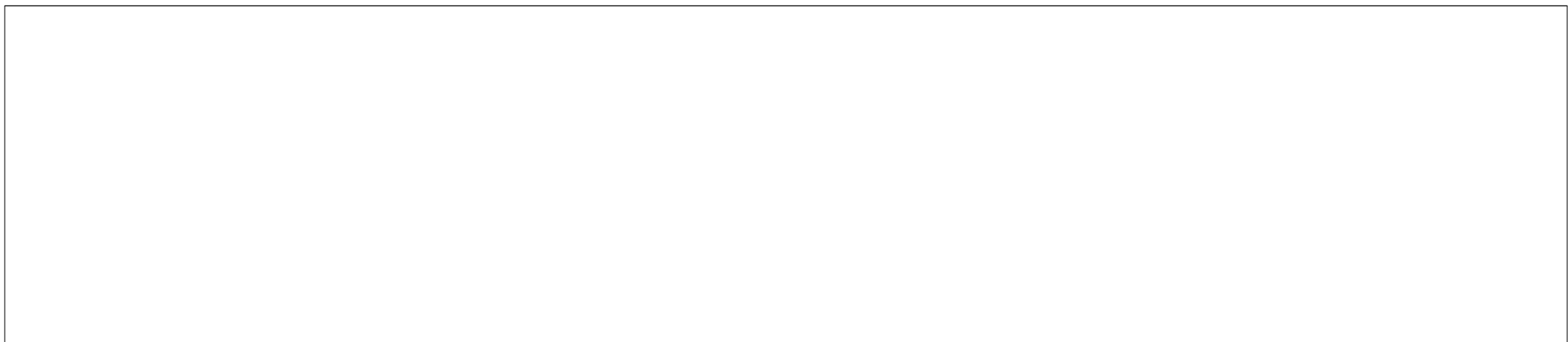
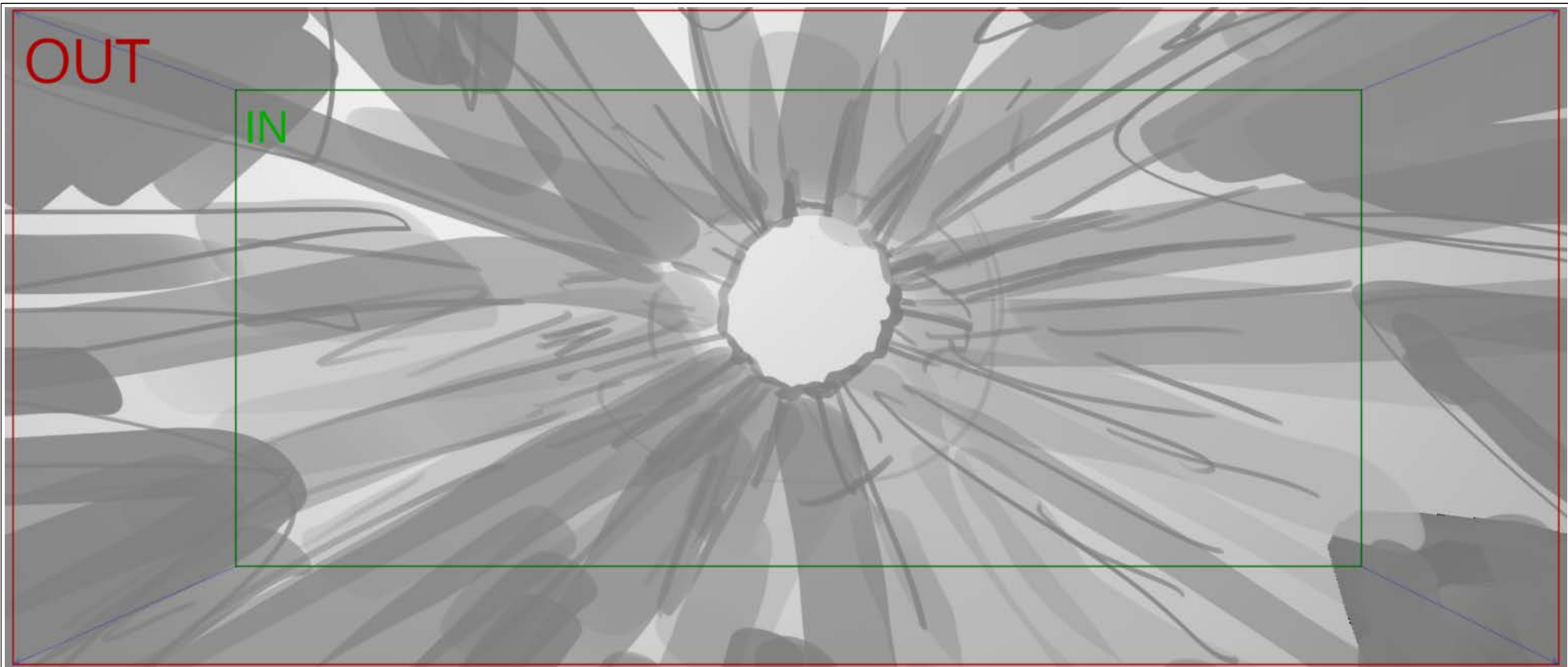

Scene	Duration	Panel	Duration
520	01:19	02A	00:05

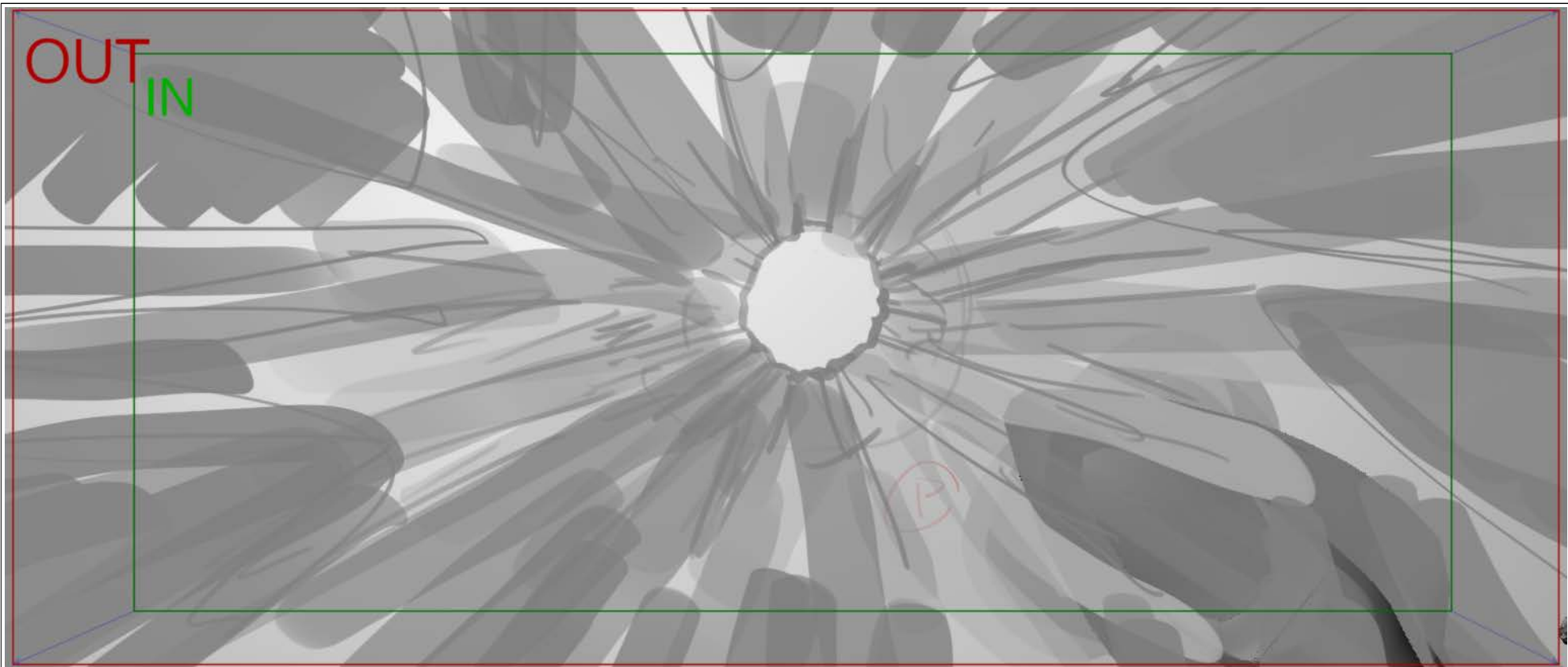

Scene	Duration	Panel	Duration
520	01:19	03A	00:15

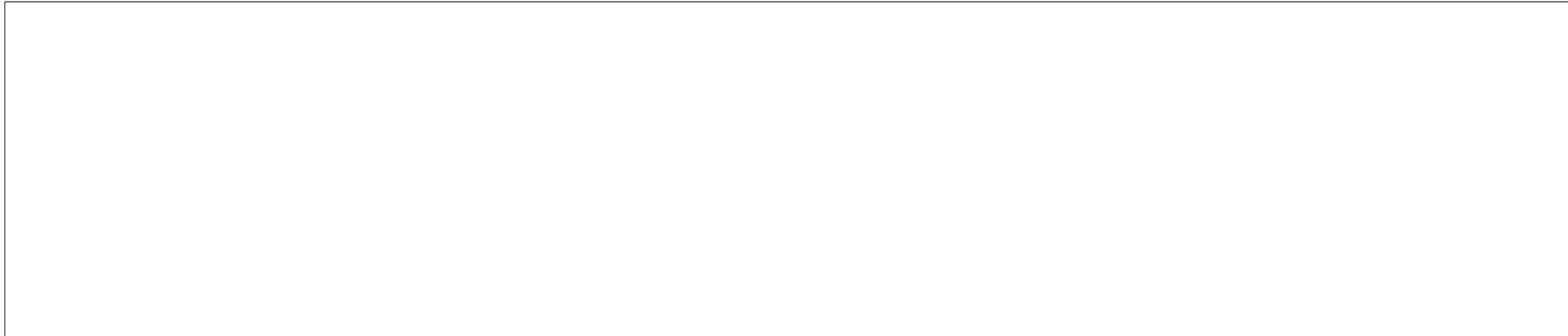
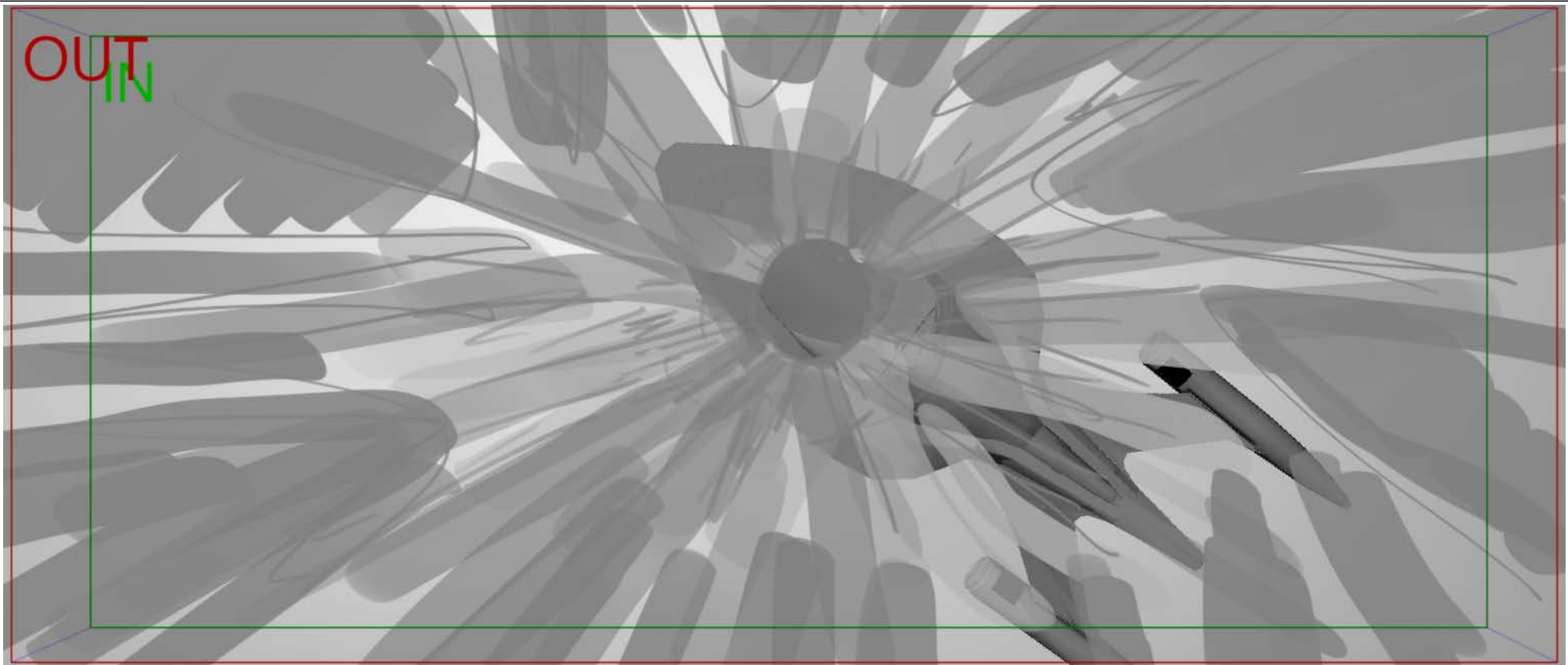

Scene	Duration	Panel	Duration
525	00:14	001	00:14

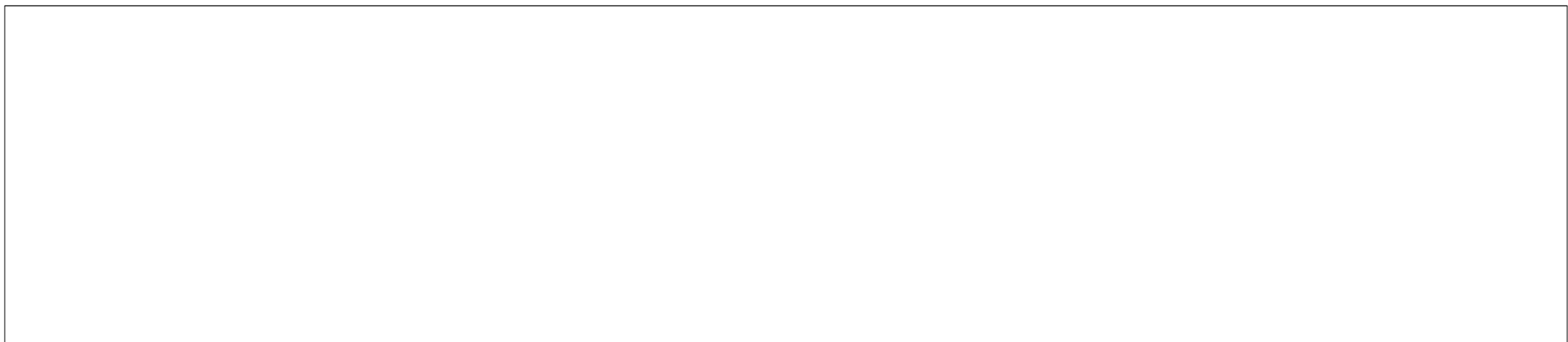
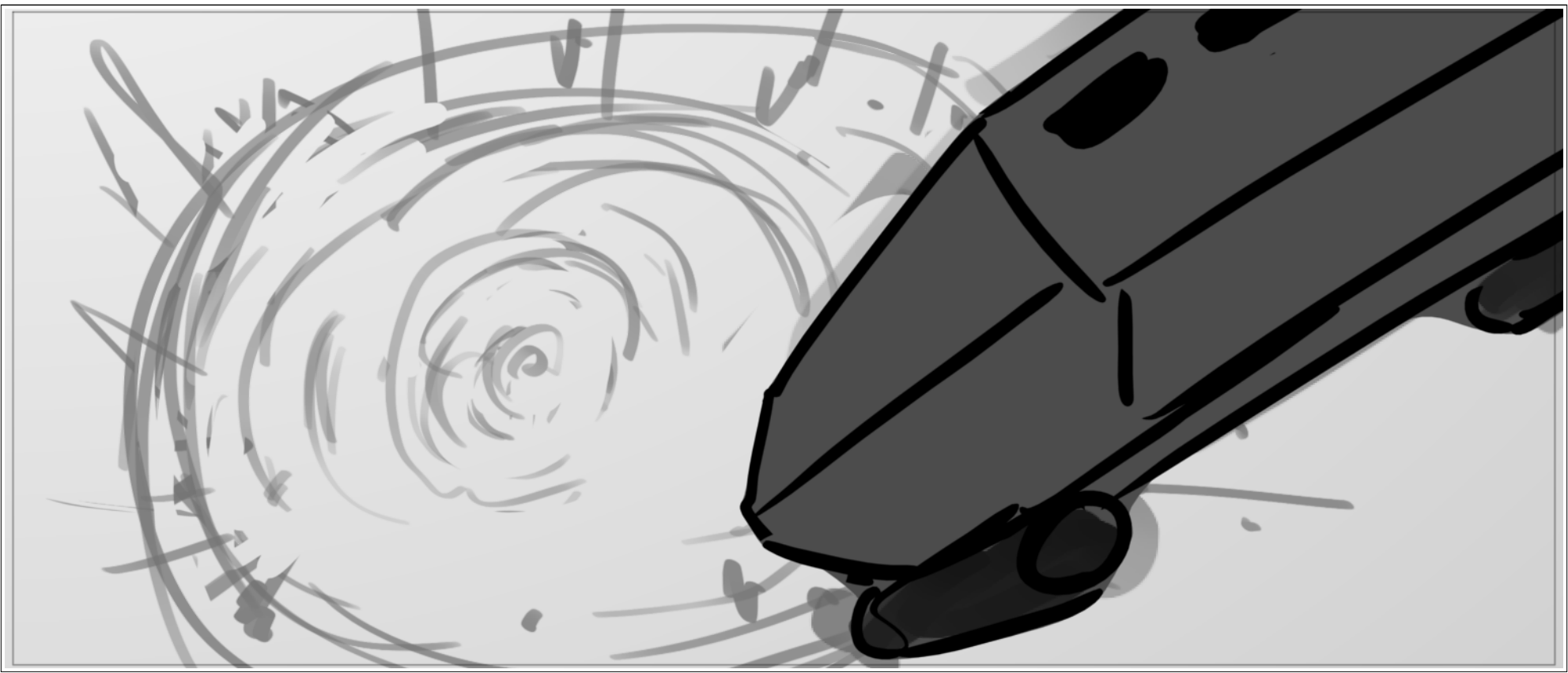

Scene	Duration	Panel	Duration
530	00:23	001	00:08

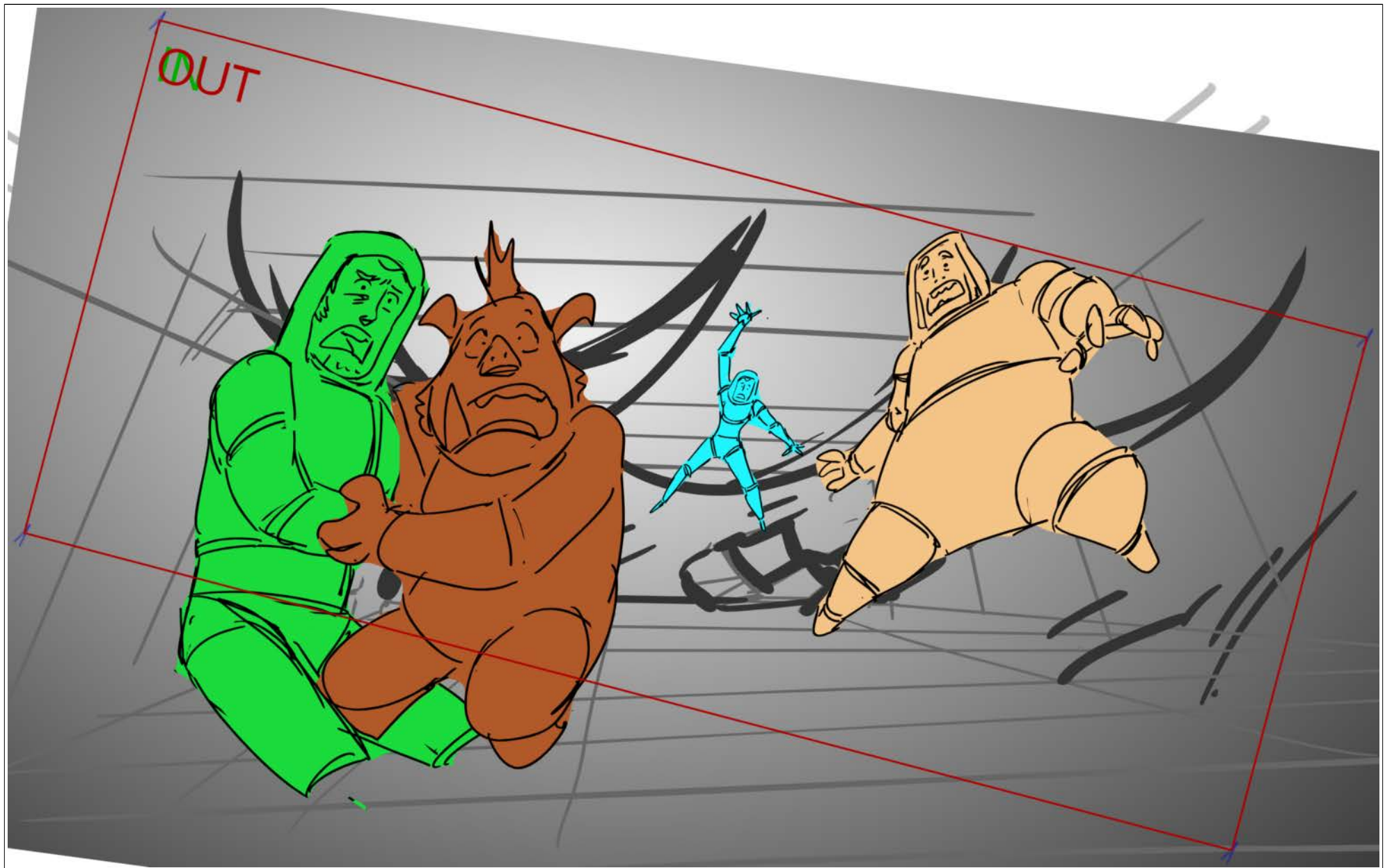

Scene	Duration	Panel	Duration
530	00:23	001A	00:01



Action Notes

CHARACTERS TELEPORT OUT

Scene	Duration	Panel	Duration
530	00:23	001A0	00:01



Scene	Duration	Panel	Duration
530	00:23	001D	00:01

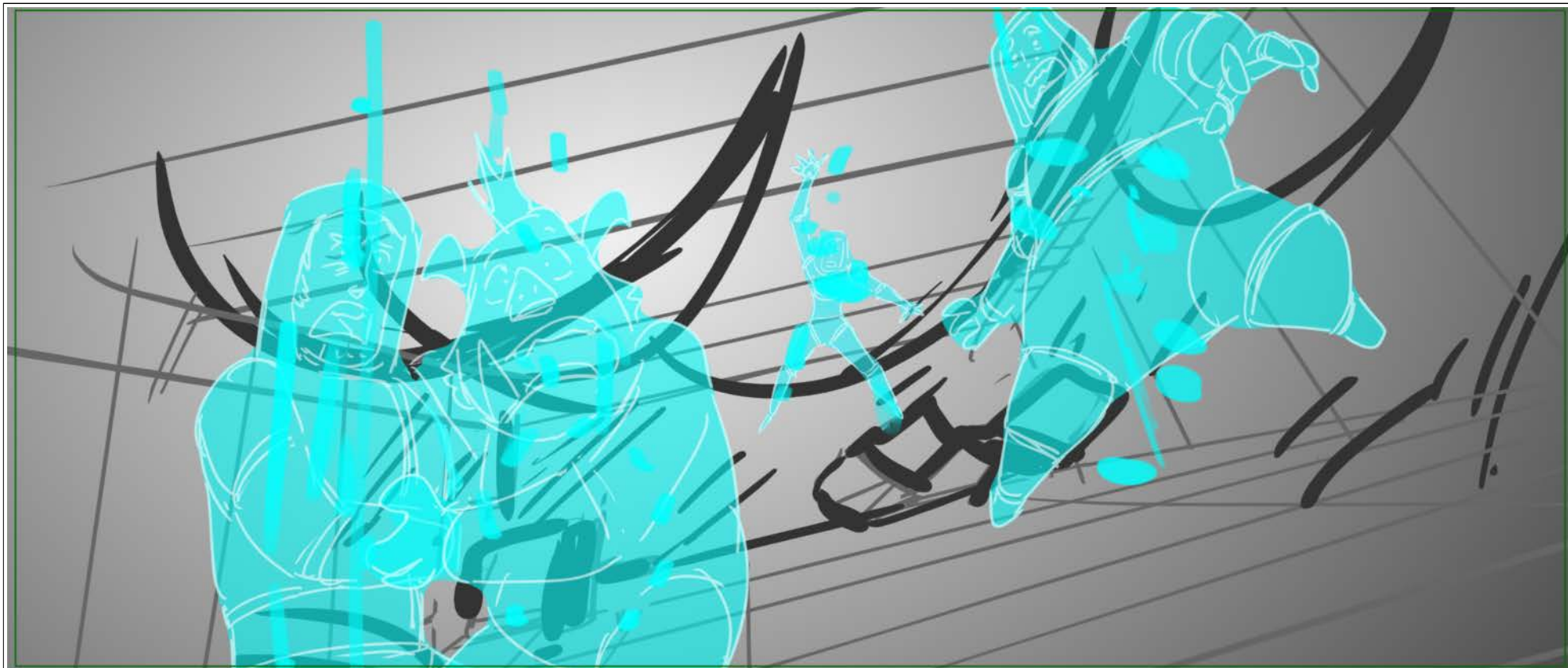

Action Notes

CHARACTERS TELEPORT OUT

Scene	Duration	Panel	Duration
530	00:23	001C	00:01



Action Notes

CHARACTERS TELEPORT OUT

Scene	Duration	Panel	Duration
530	00:23	001B	00:01

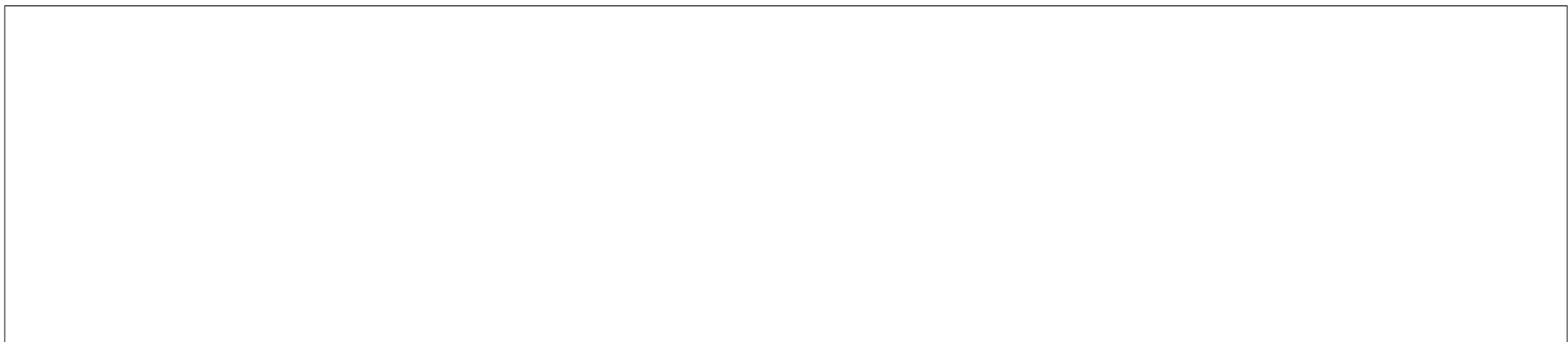
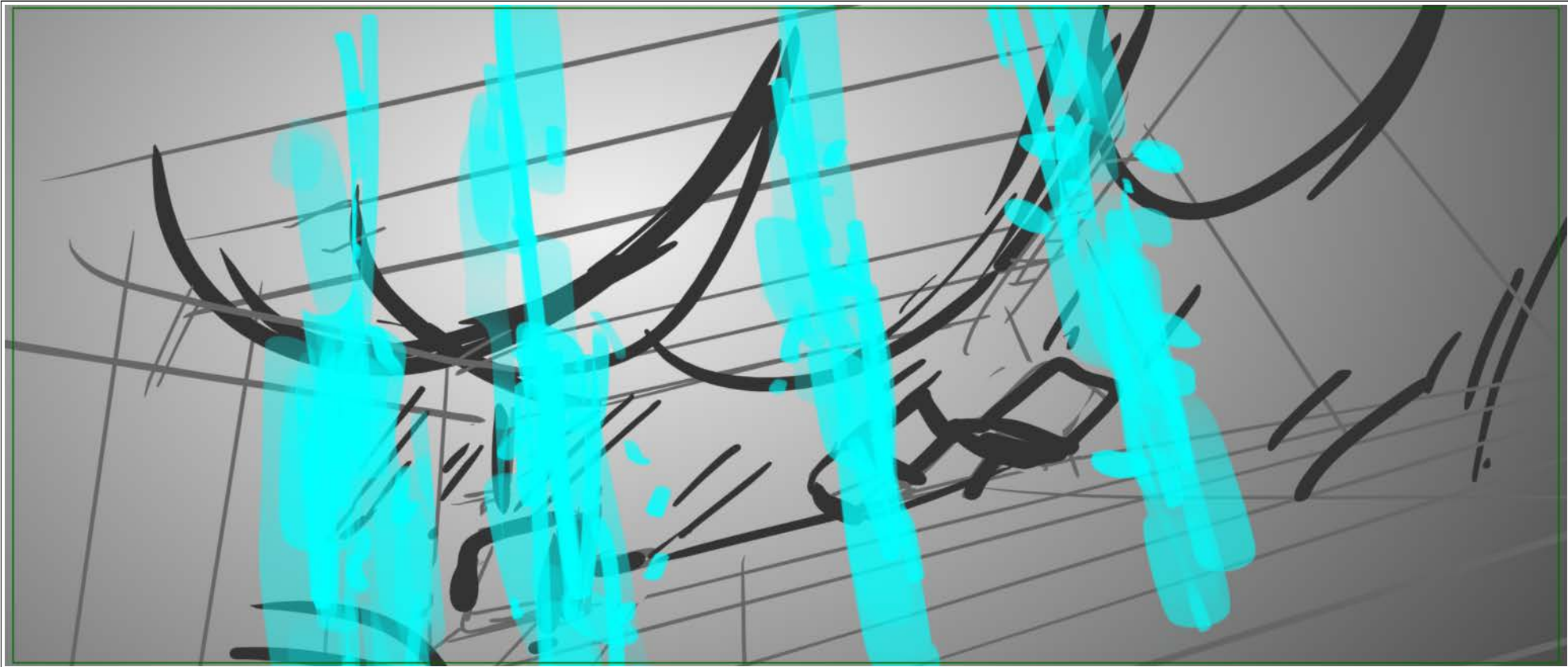

Scene	Duration	Panel	Duration
530	00:23	001E	00:02

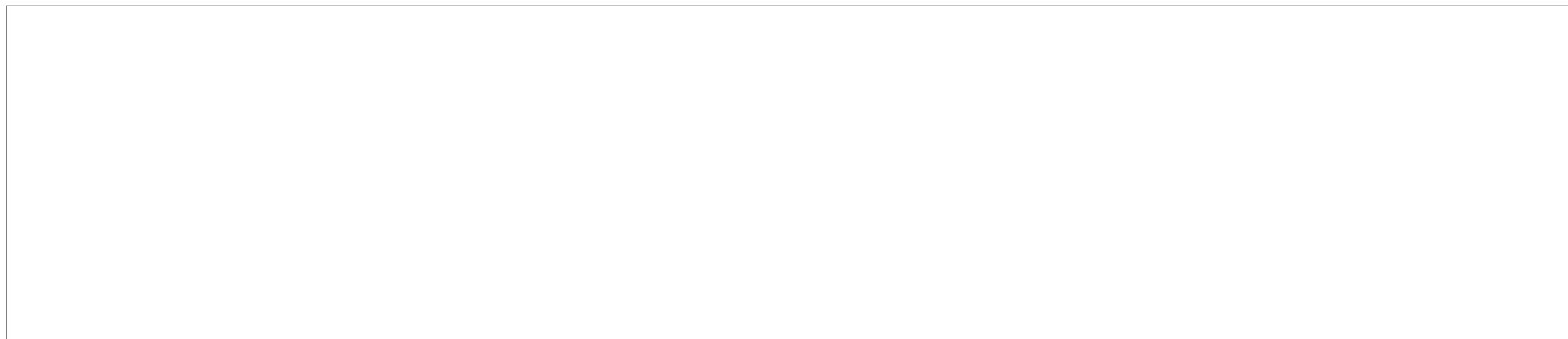
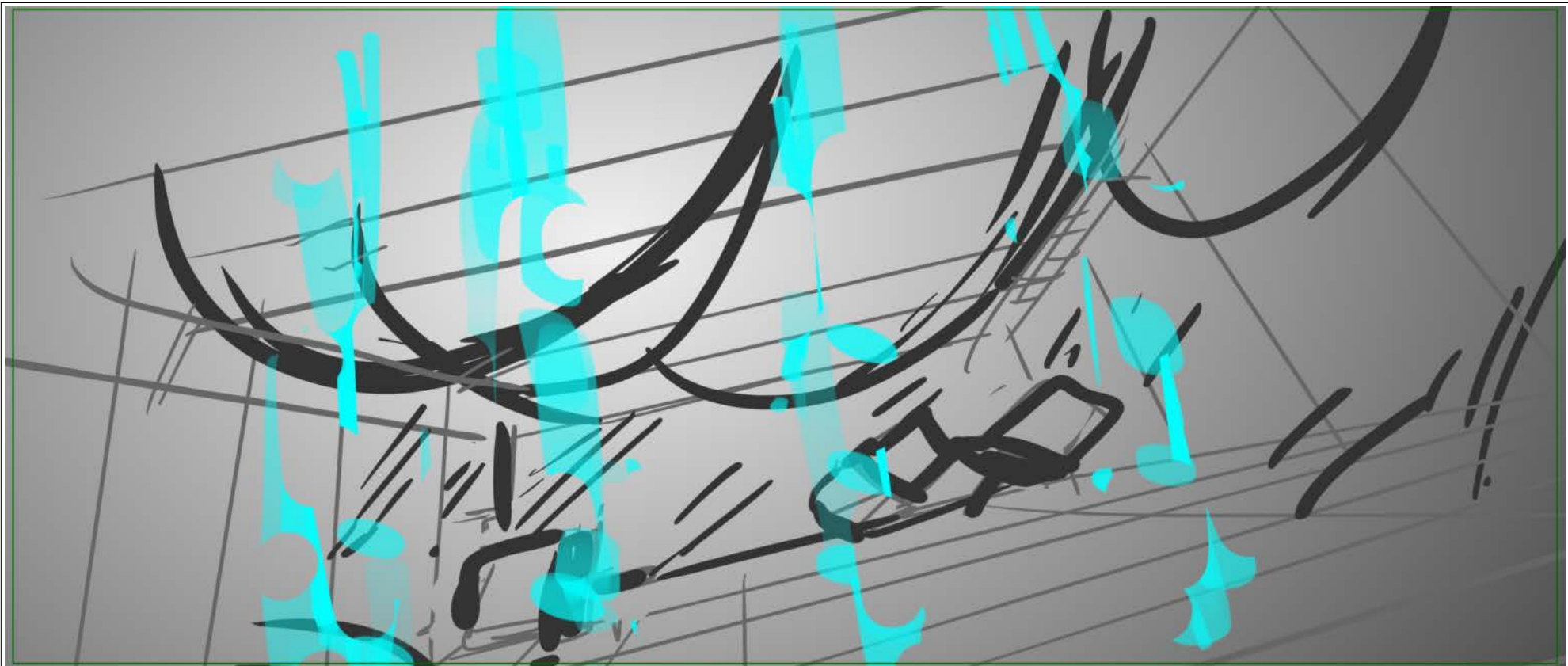

Scene	530	Duration	00:23	Panel	001F	Duration	00:02
-------	-----	----------	-------	-------	------	----------	-------

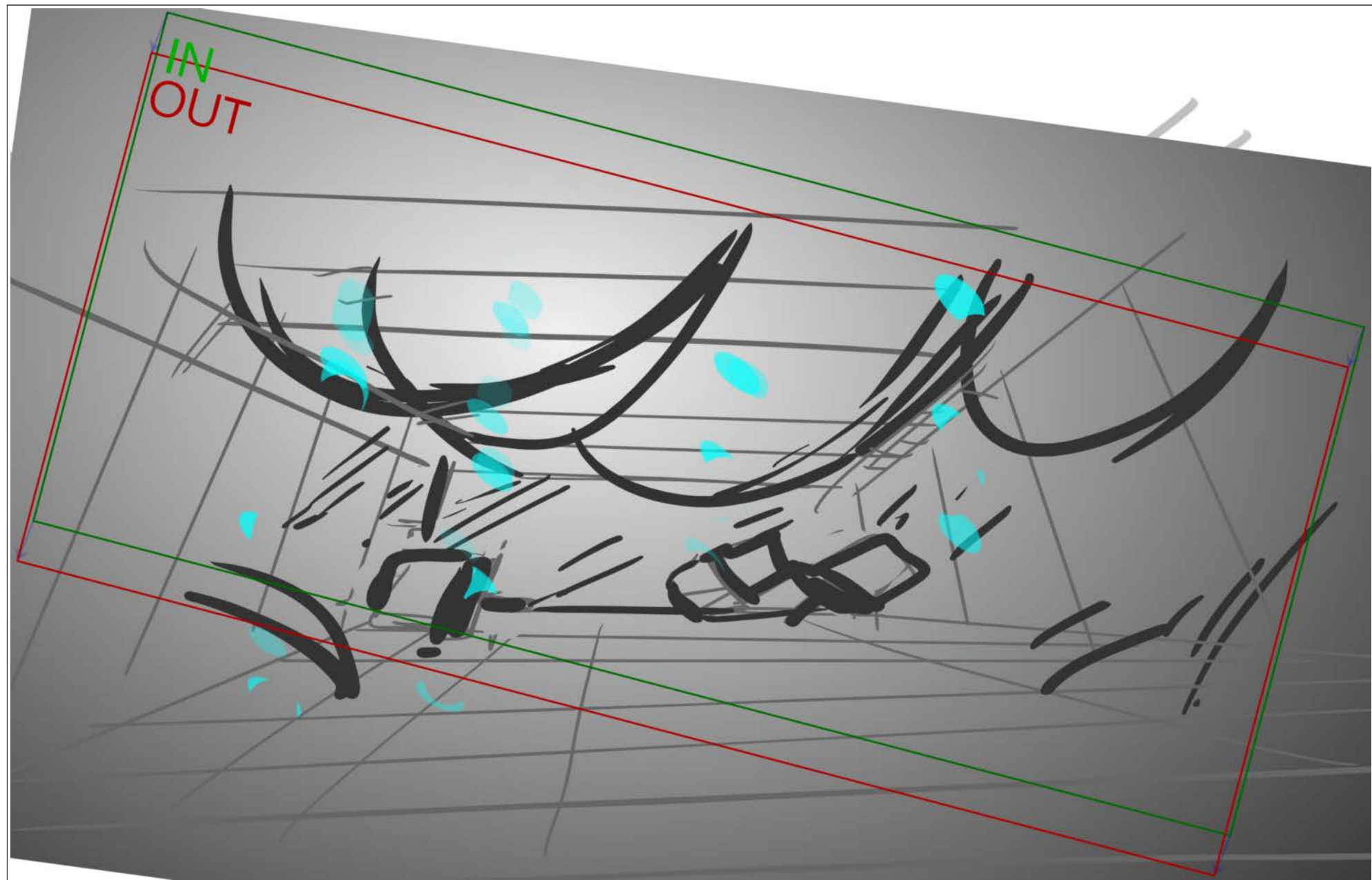

Scene	Duration	Panel	Duration
530	00:23	02B	00:06

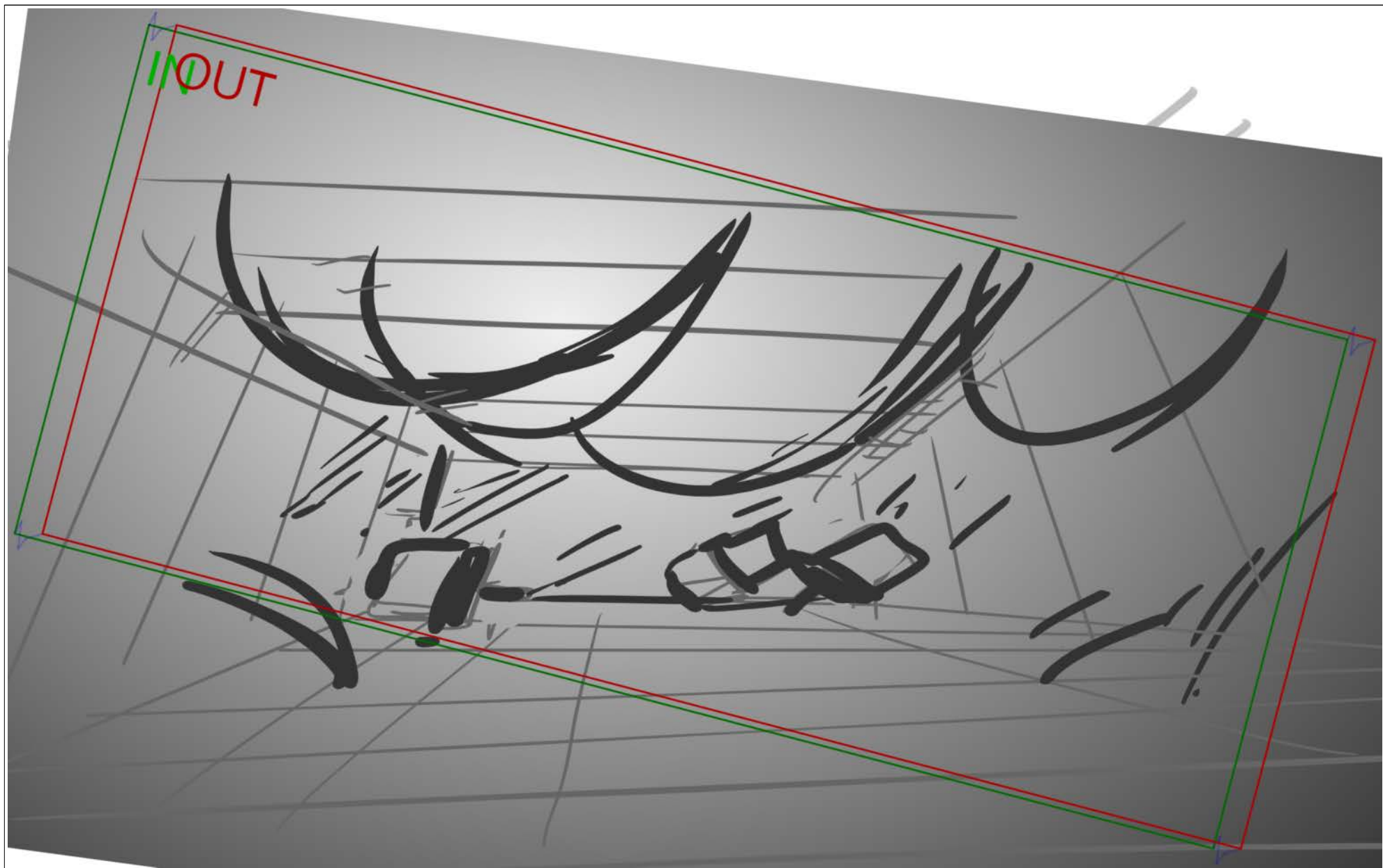

Scene	Duration	Panel	Duration
540	00:11	001	00:03

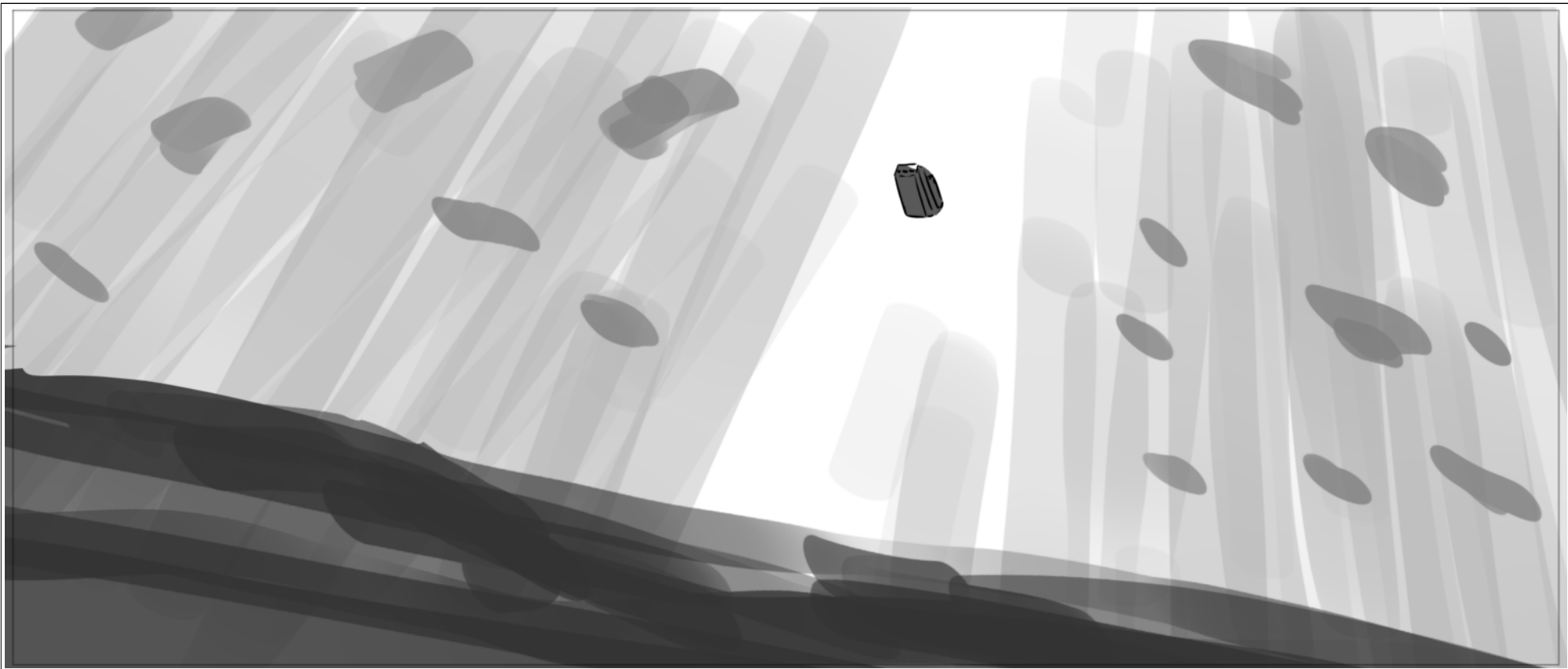

Scene	Duration	Panel	Duration
540	00:11	002	00:03

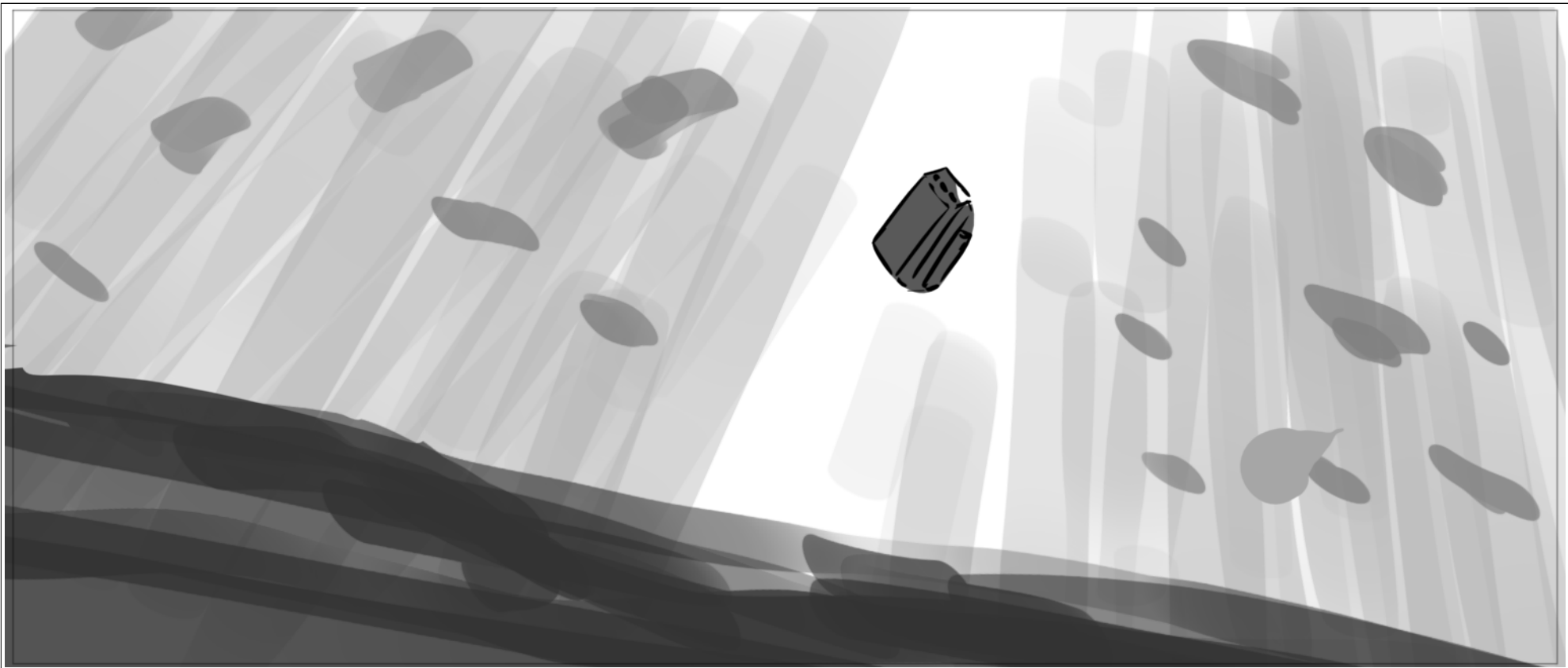

Scene	Duration	Panel	Duration
540	00:11	001A	00:05

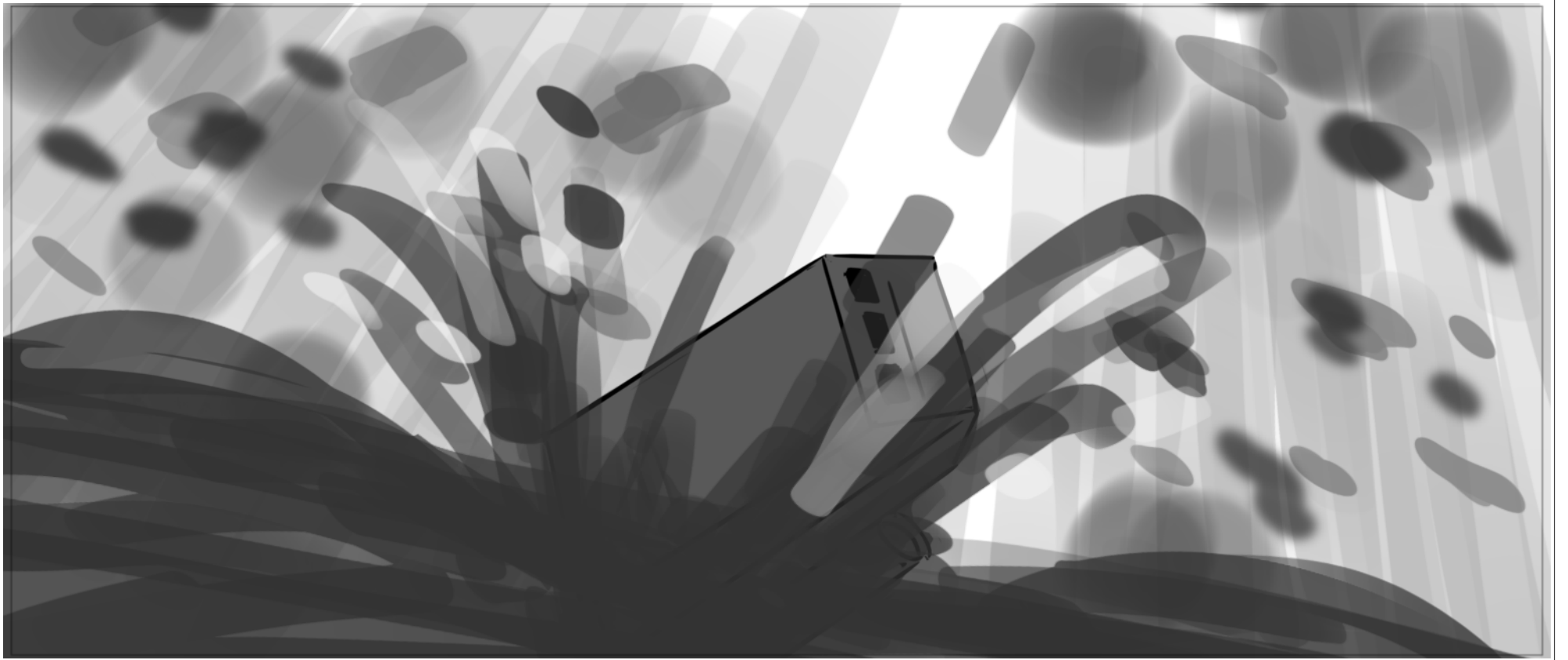

Action Notes

GALILEO FALLS INTO PIT

Scene	Duration	Panel	Duration
550	01:22	001	00:10



Scene	Duration	Panel	Duration
550	01:22	001A0	00:04

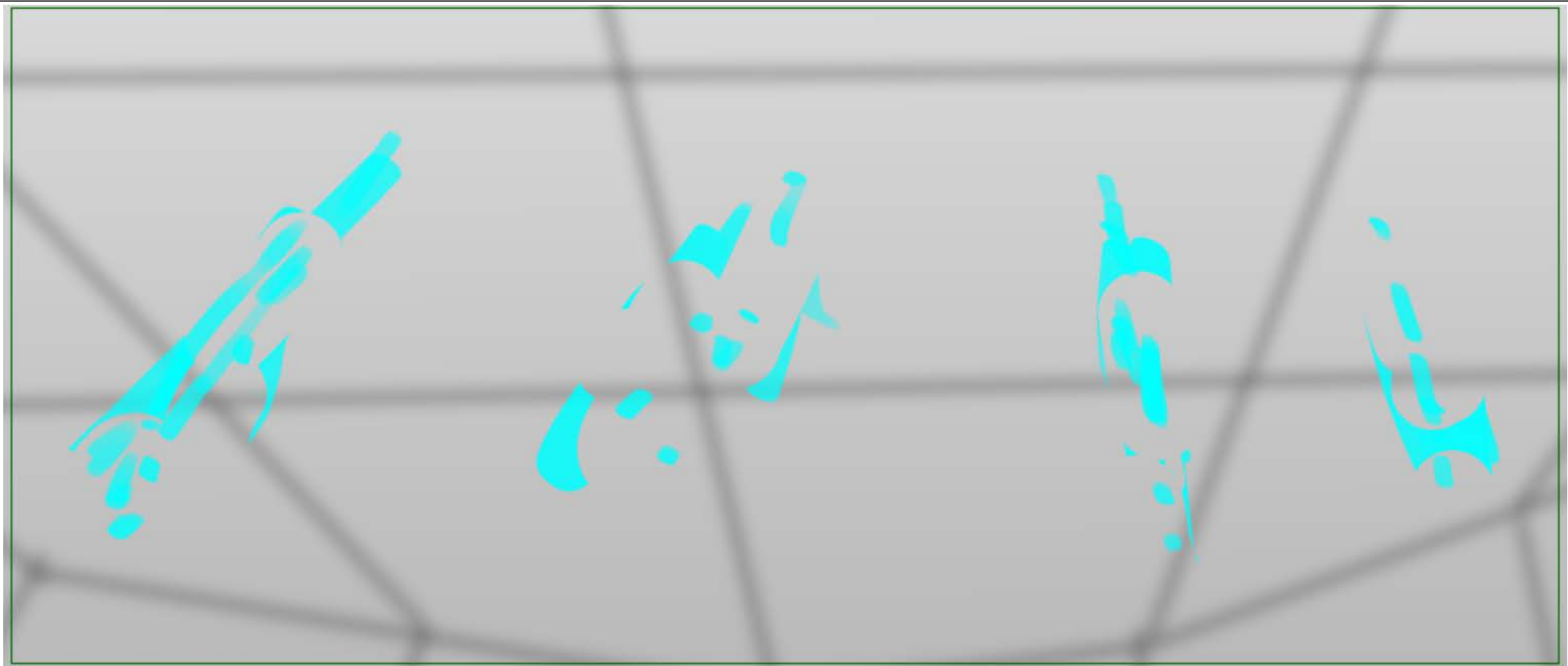

Action Notes

CHARACTERS TELEPORT INTO PROTOSTAR

Scene	Duration	Panel	Duration
550	01:22	001A5	00:01

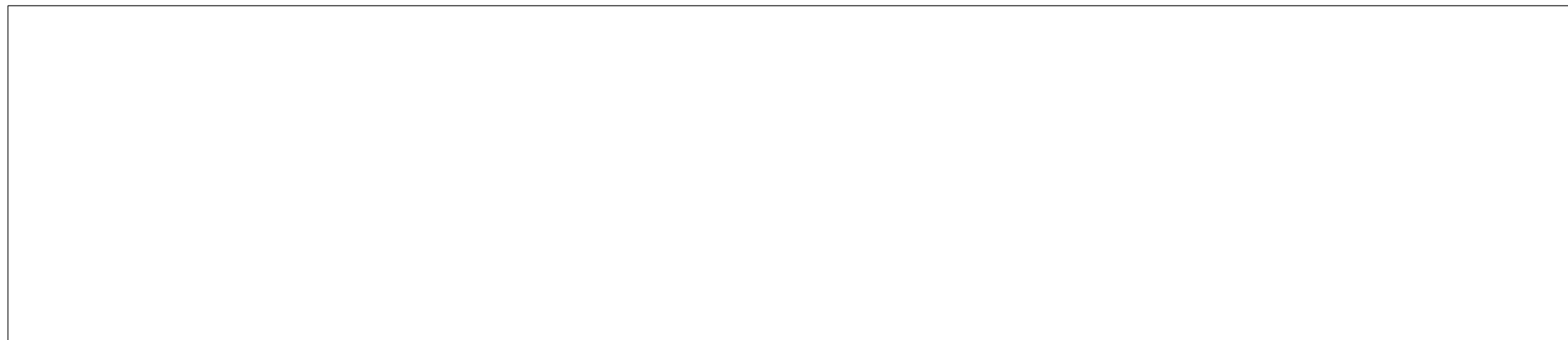
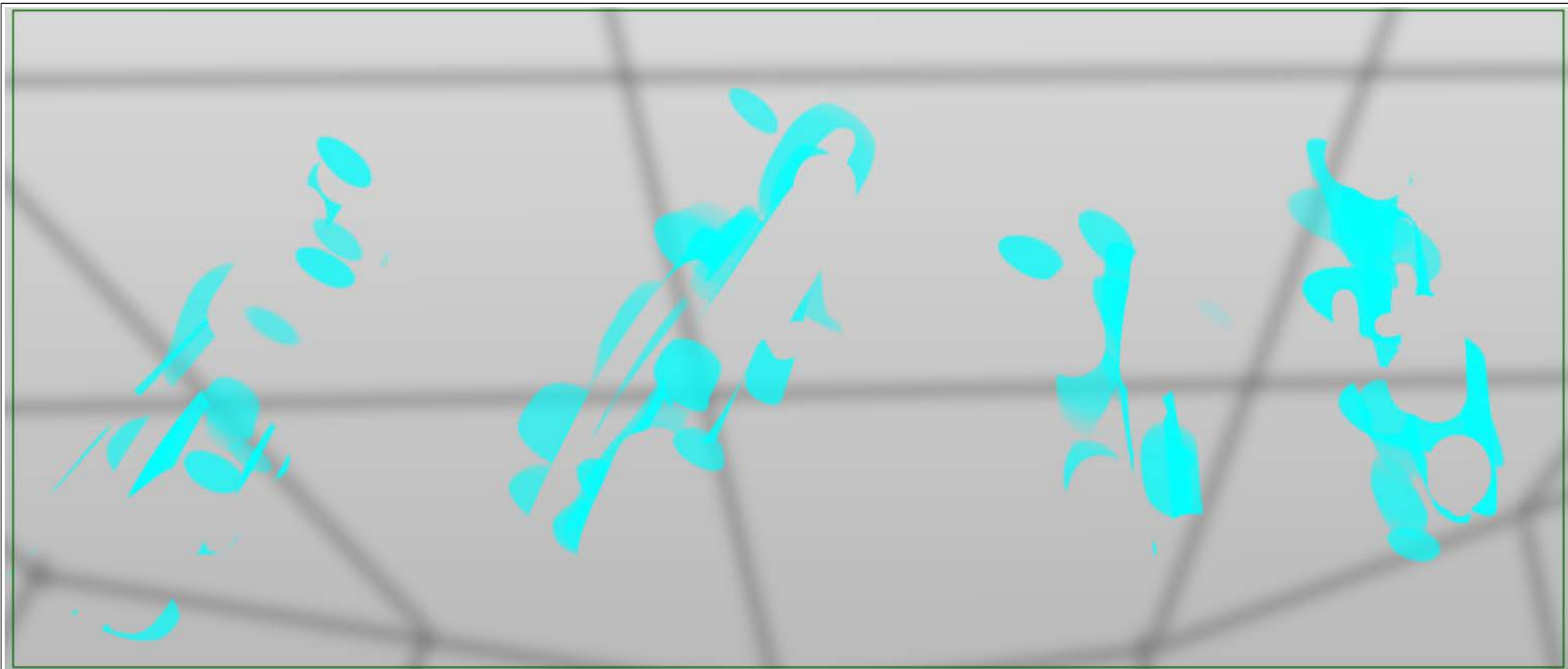

Scene	Duration	Panel	Duration
550	01:22	001A6	00:01

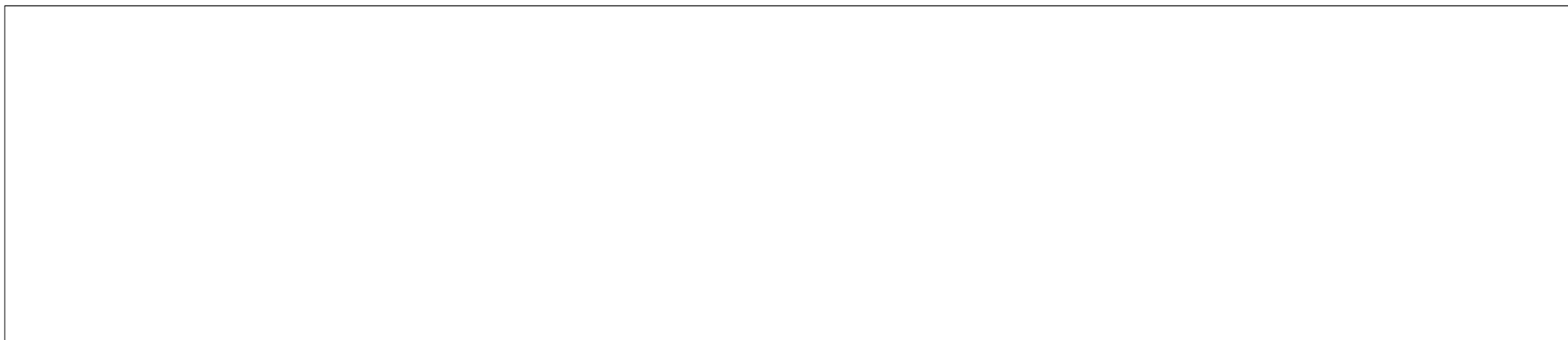
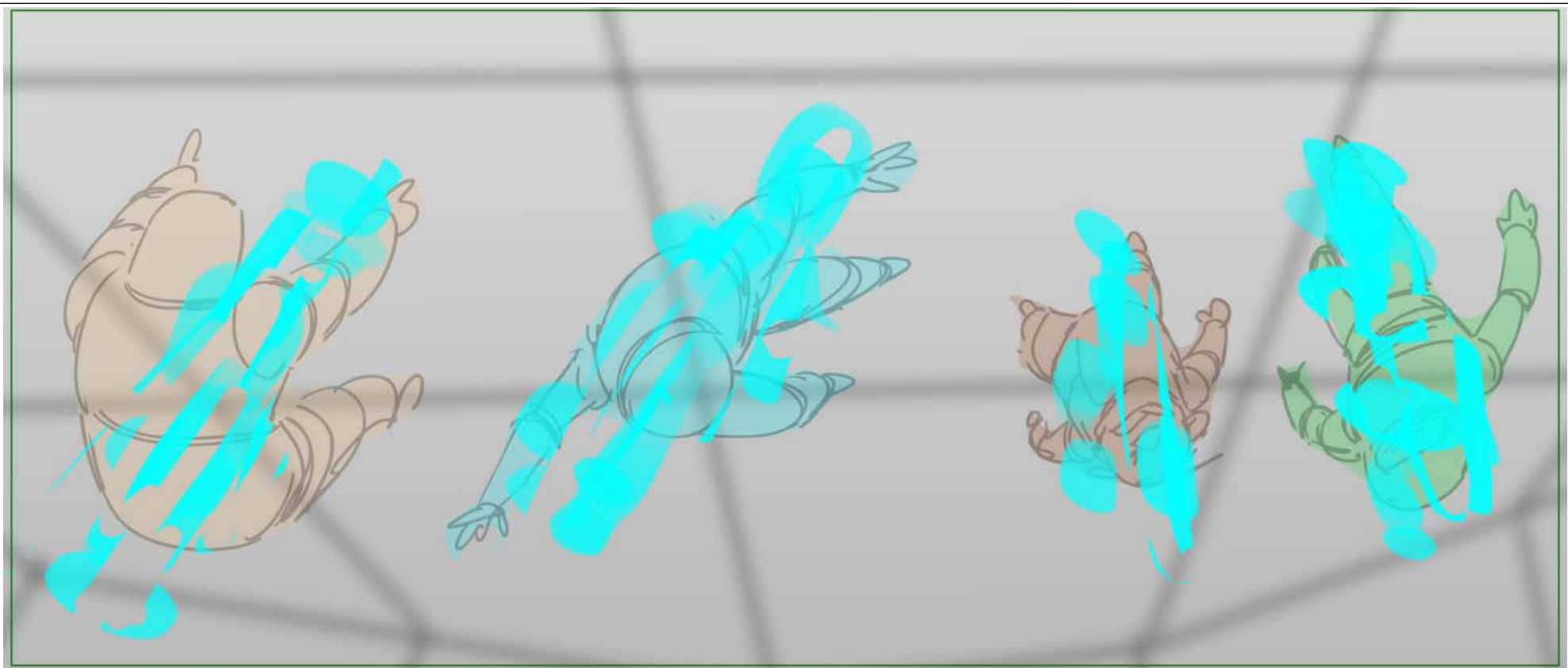

Scene	Duration	Panel	Duration
550	01:22	001A1	00:03

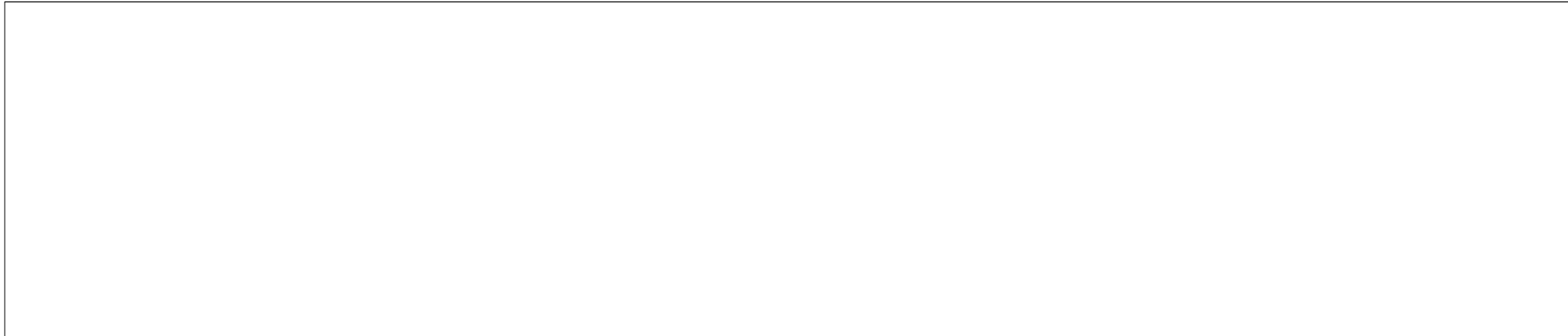
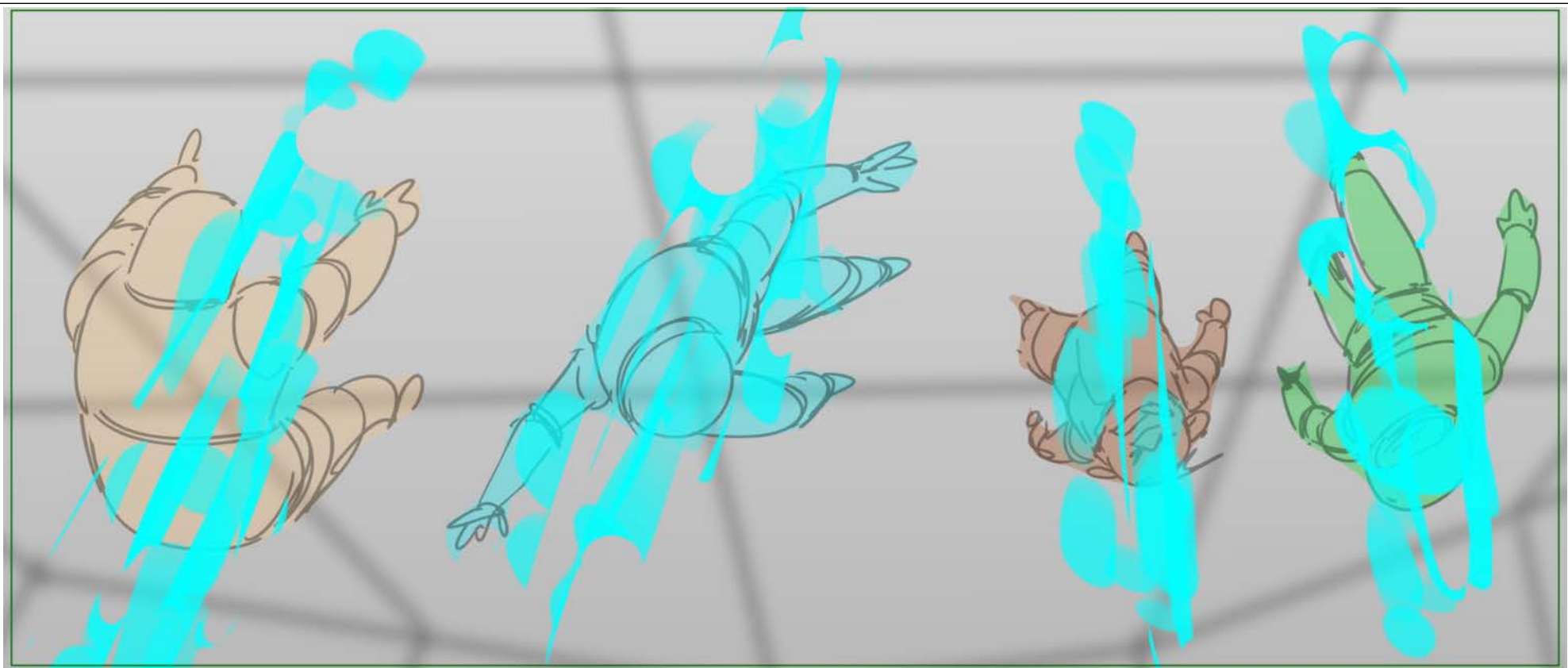

Scene	Duration	Panel	Duration
550	01:22	001A2	00:02

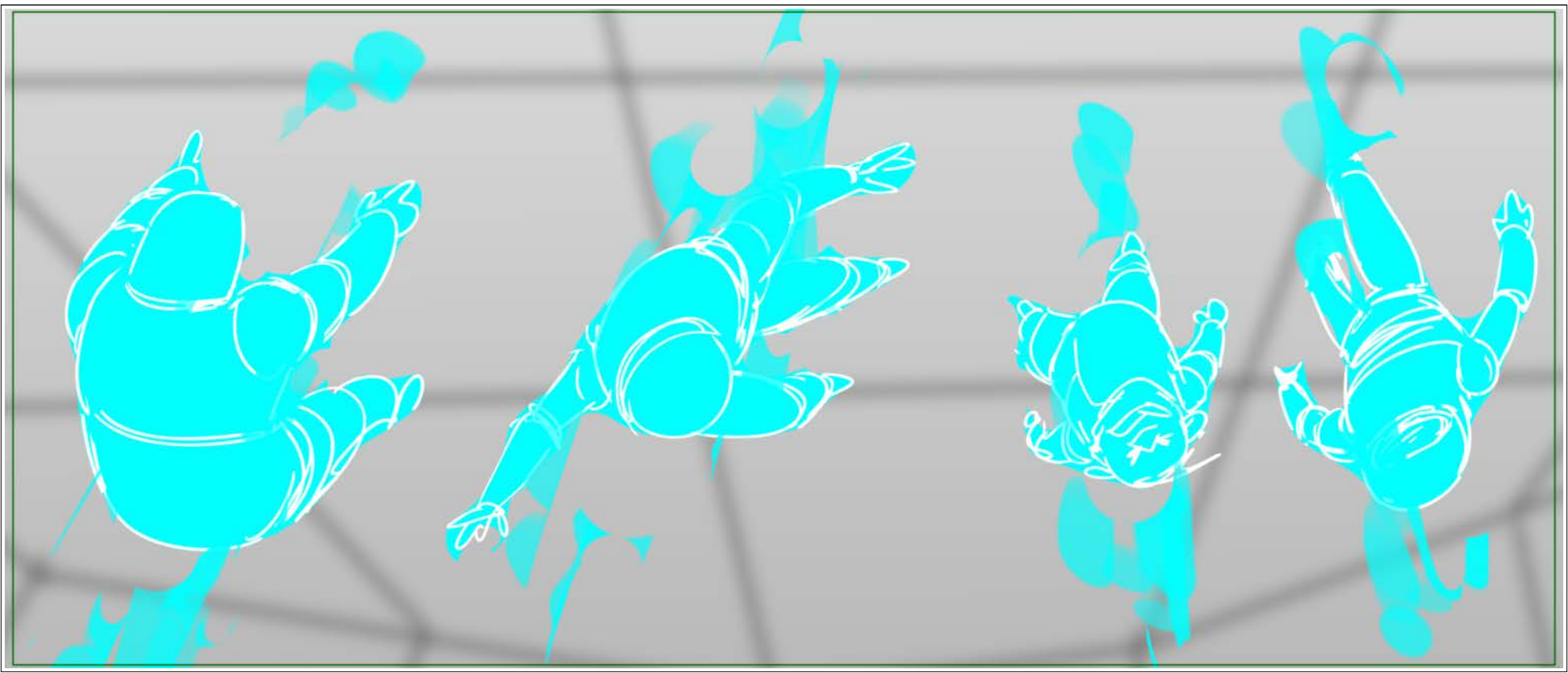

Scene	Duration	Panel	Duration
550	01:22	001A3	00:01

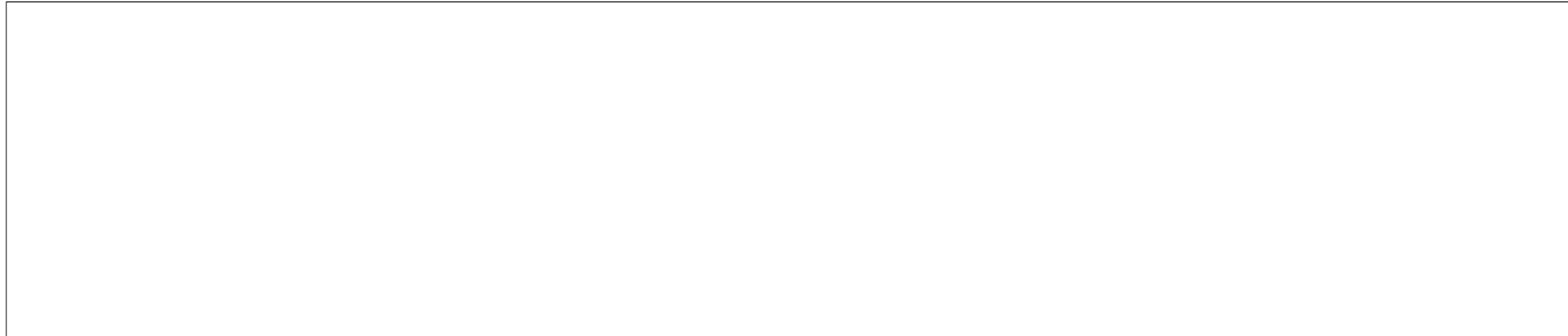
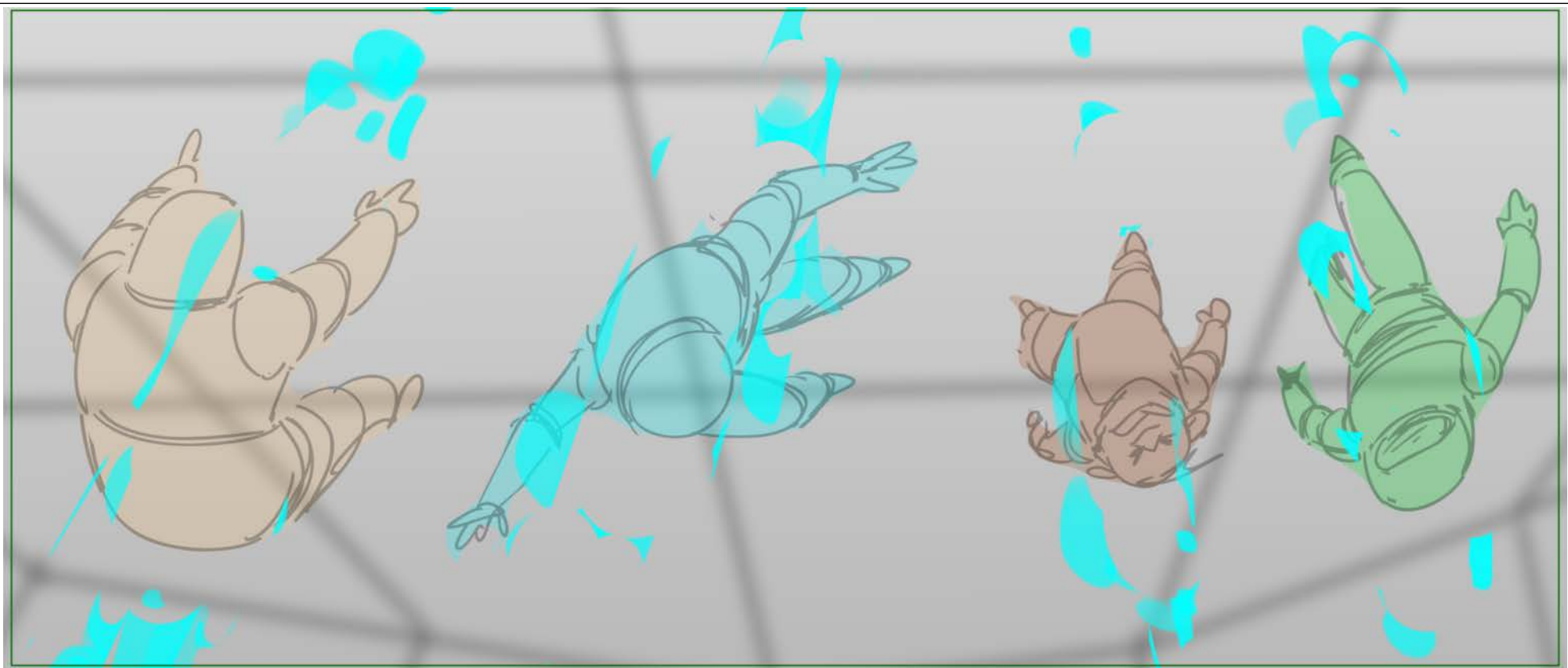

Scene	Duration	Panel	Duration
550	01:22	001A4	00:04

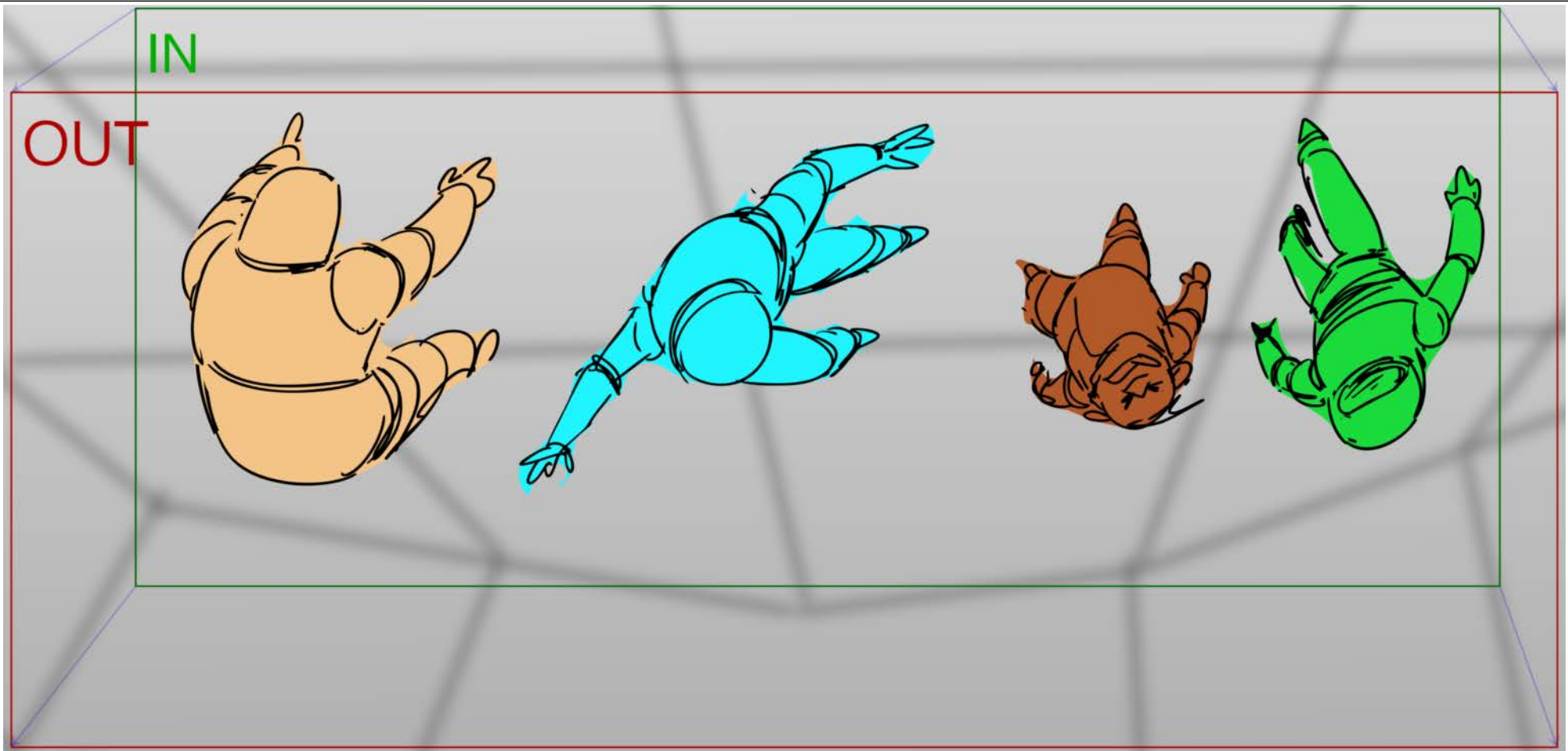

Scene	Duration	Panel	Duration
550	01:22	001A	00:01

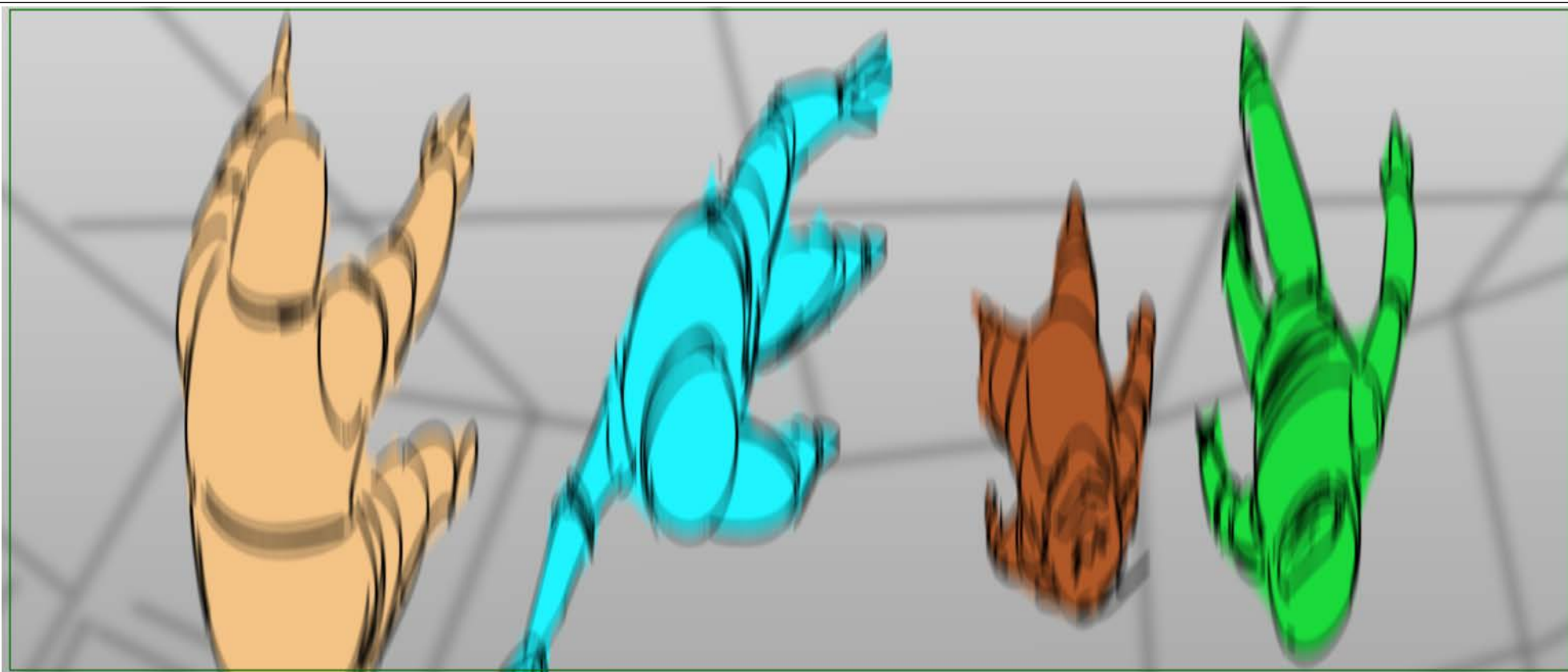

Action Notes

CAMERA FOLLOW AND SHAKE

Scene	Duration	Panel	Duration
550	01:22	001B	00:07

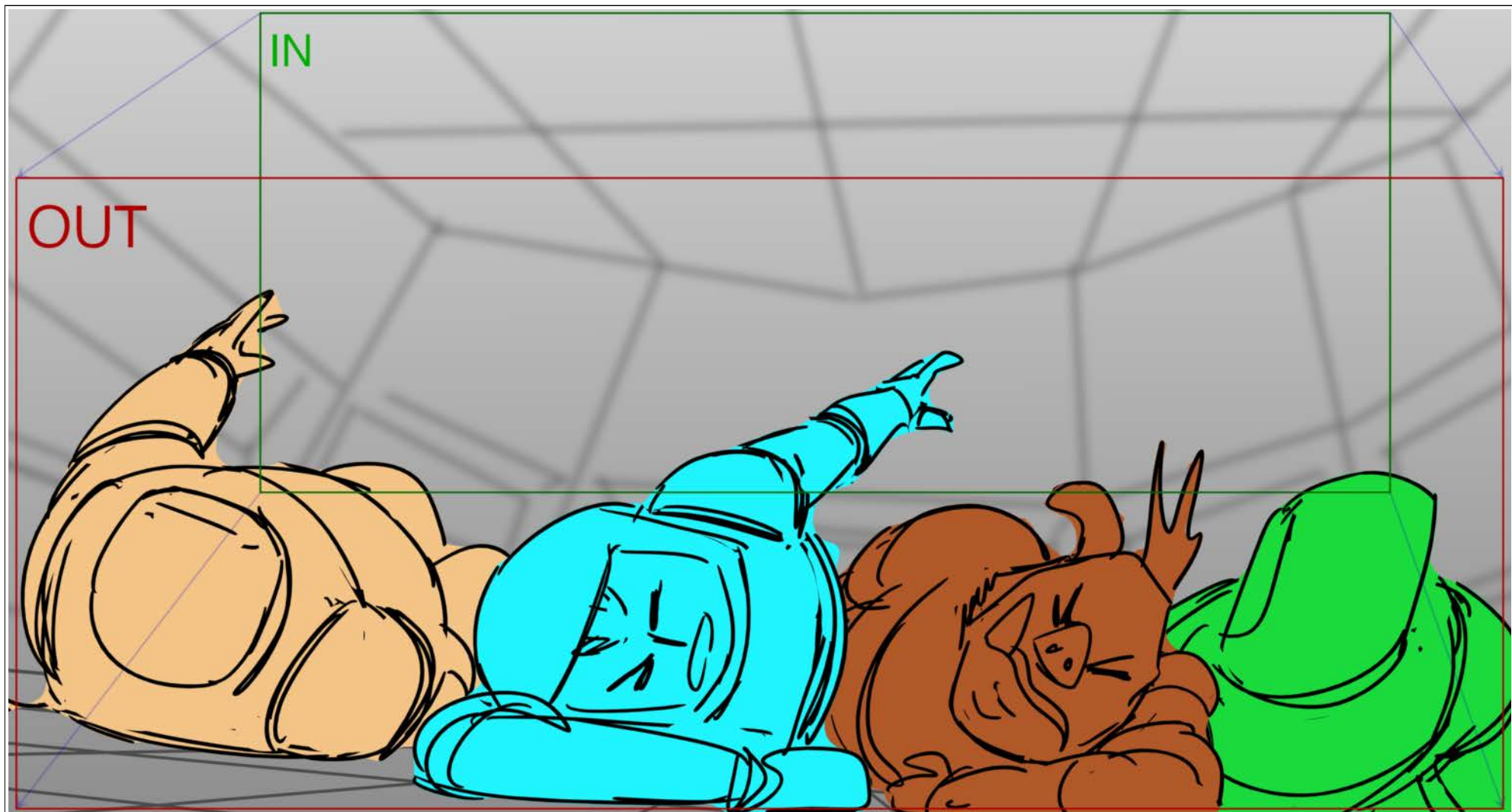

Action Notes
CAMERA FOLLOW AND SHAKE

Scene	Duration	Panel	Duration
550	01:22	02A	00:12

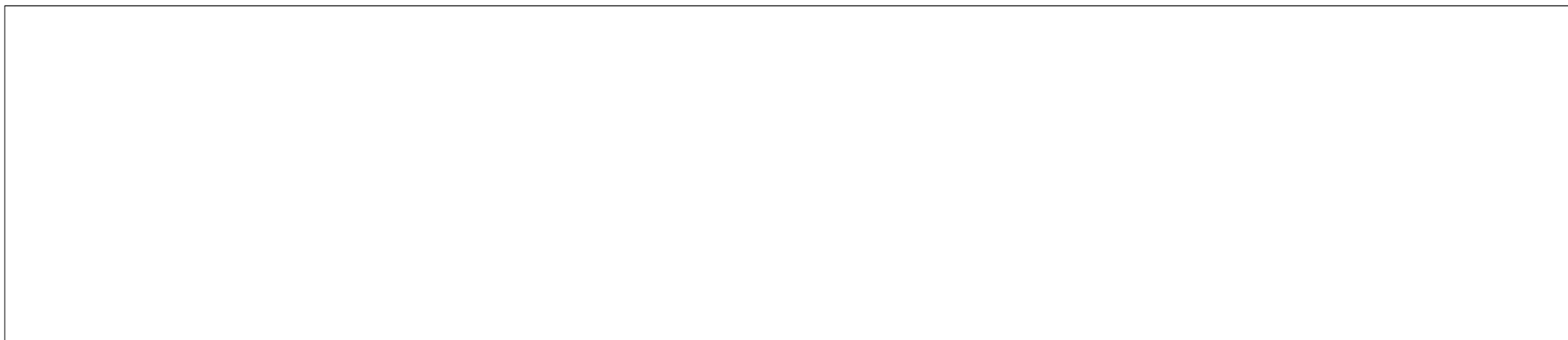
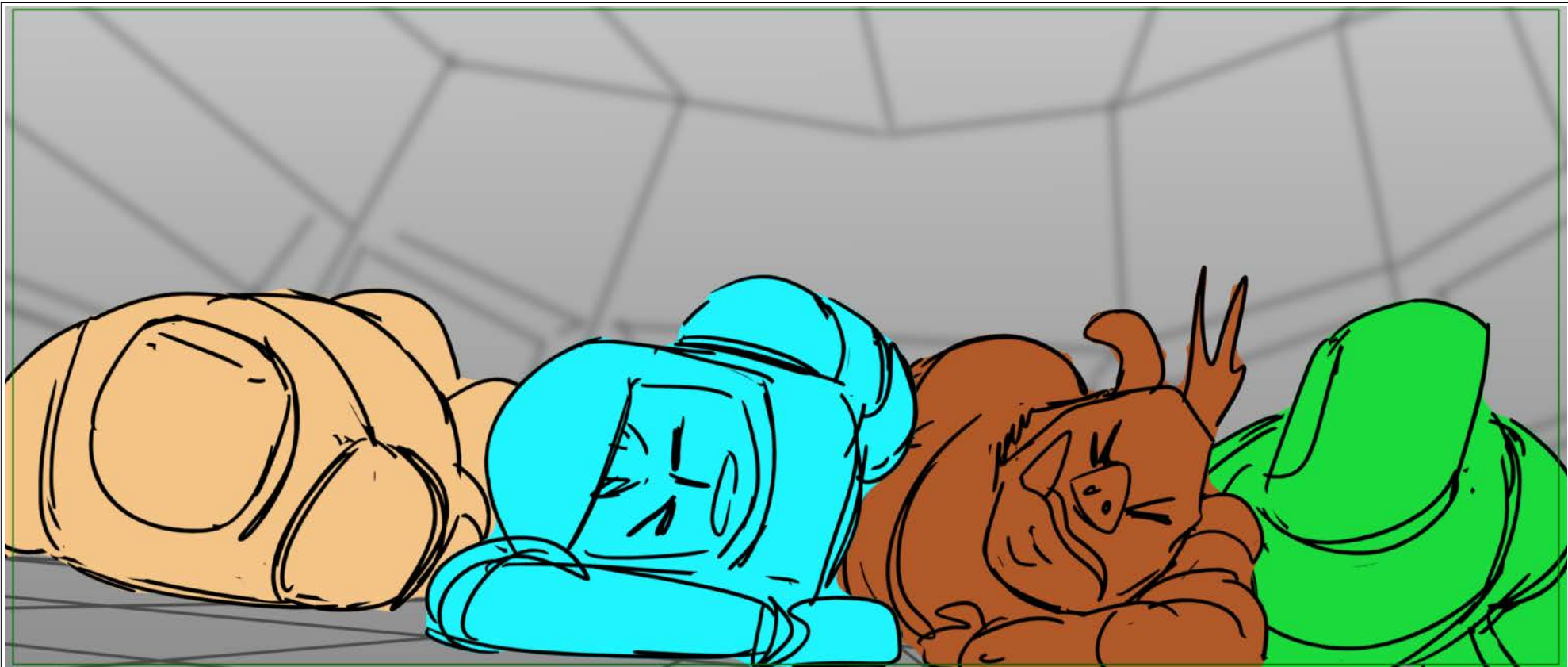

Scene	Duration	Panel	Duration
560	01:00	02A	00:11

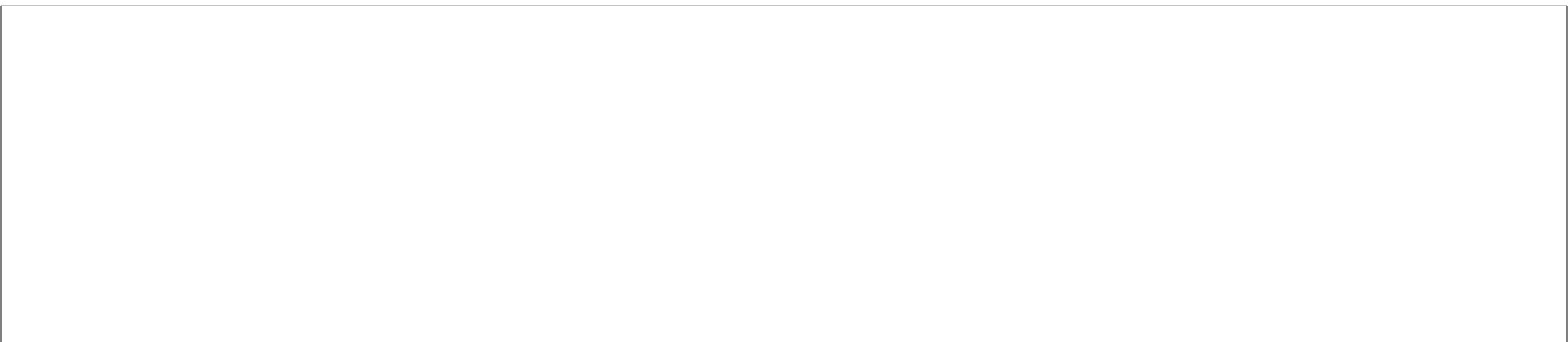
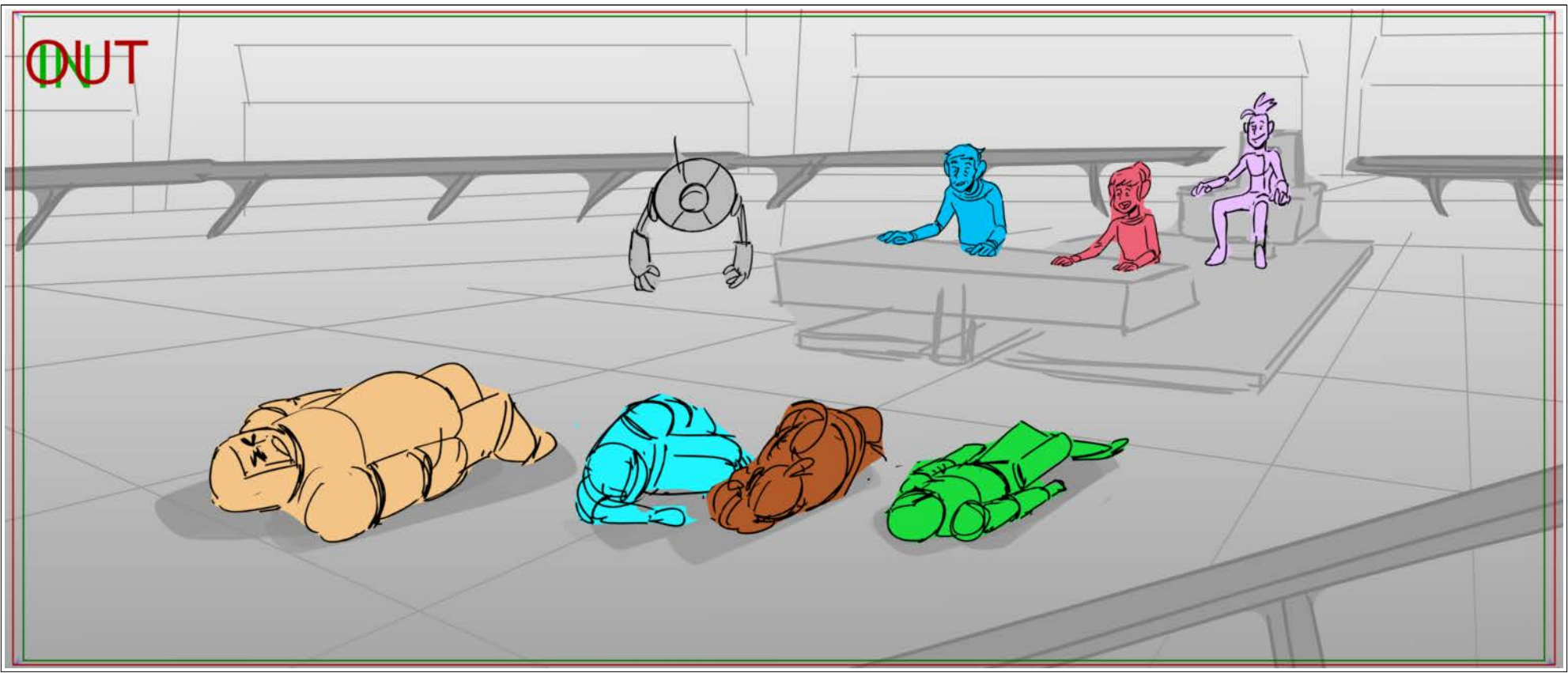

Scene	Duration	Panel	Duration
560	01:00	03A	00:13

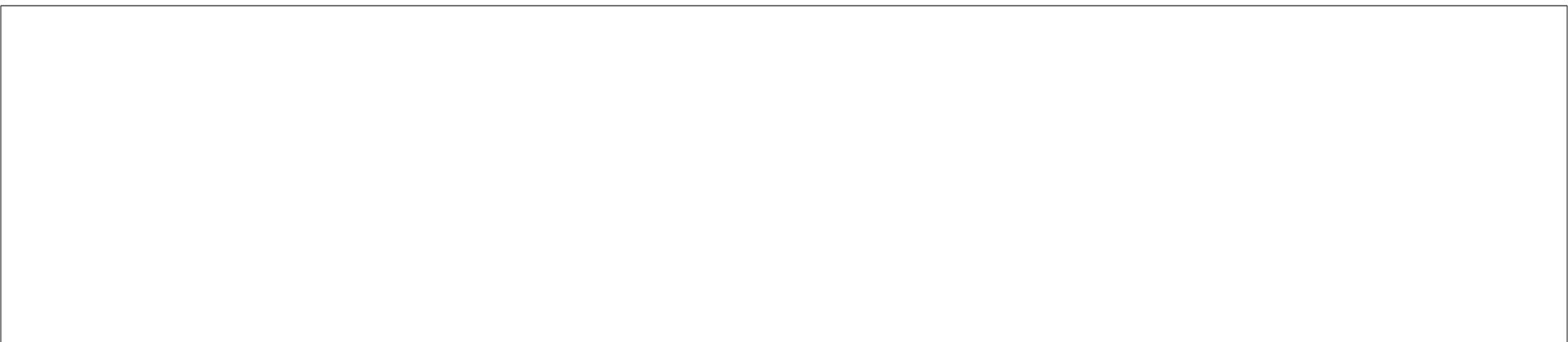
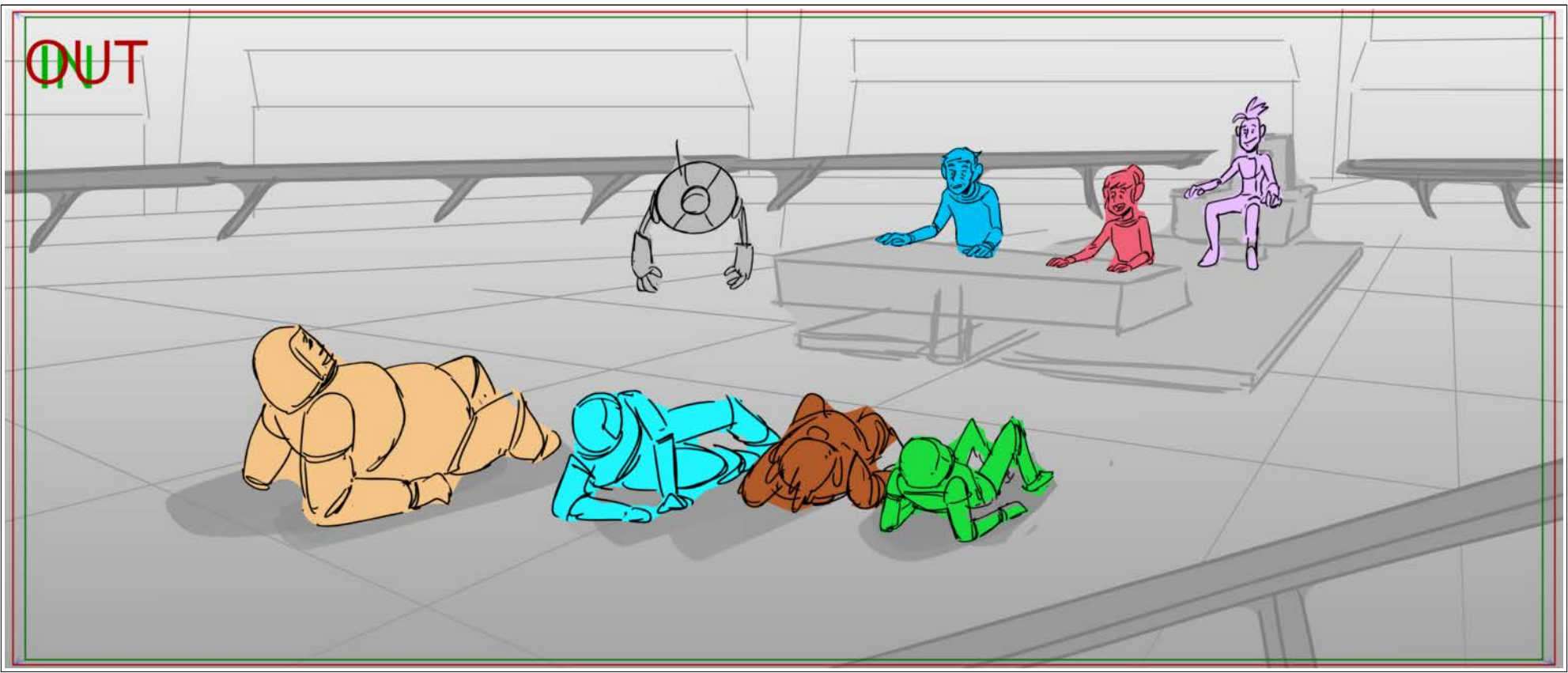

Scene	Duration	Panel	Duration
570	01:03	001	00:13



Scene	Duration	Panel	Duration
570	01:03	002	00:14

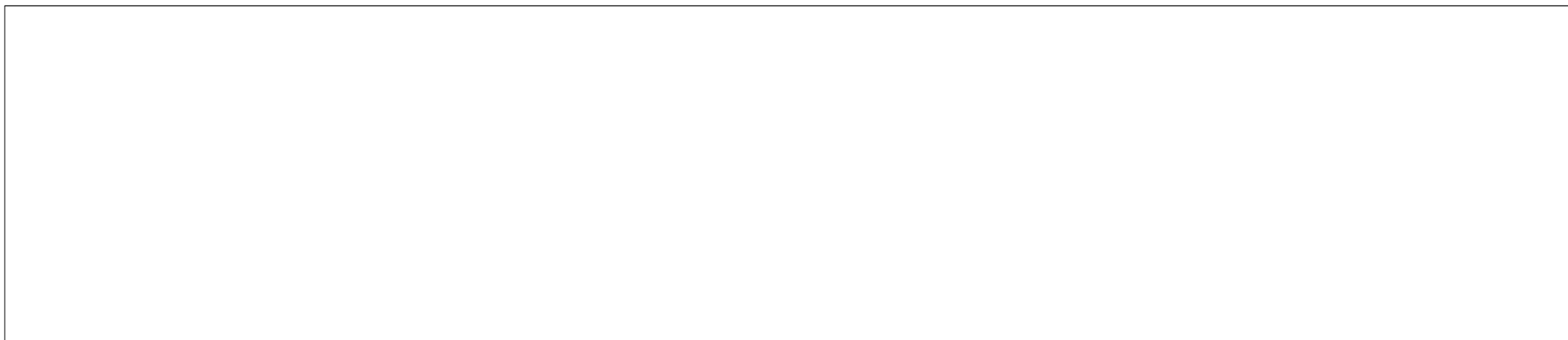

Scene	Duration	Panel	Duration
610	00:18	001	00:18



Dialog

DAL

187 Get us out of here!

Scene	Duration	Panel	Duration
570A	02:00	001A999	00:08

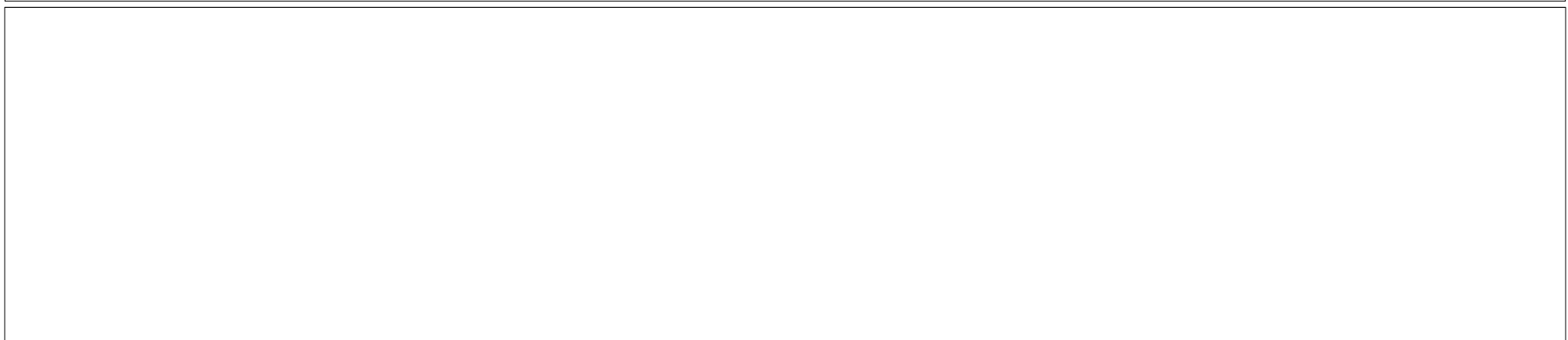
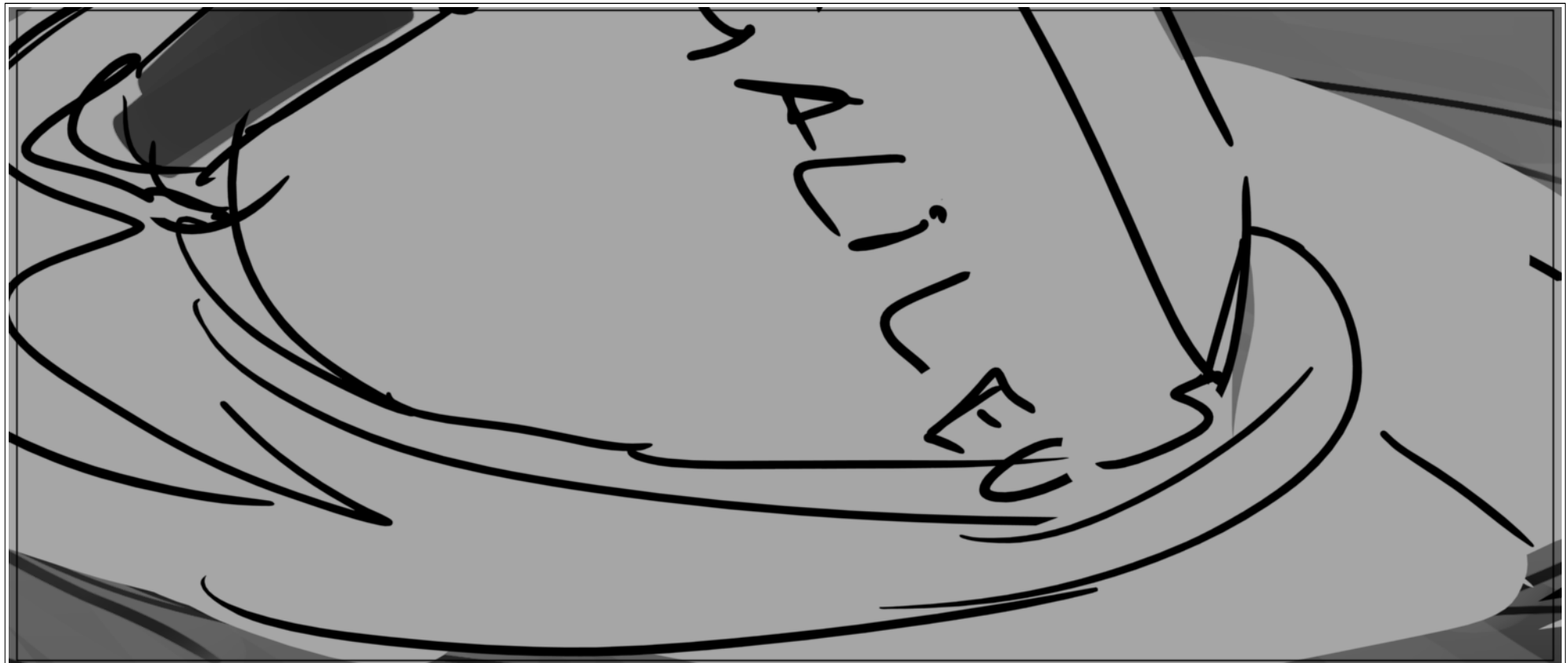

Scene	Duration	Panel	Duration
570A	02:00	002A	00:09

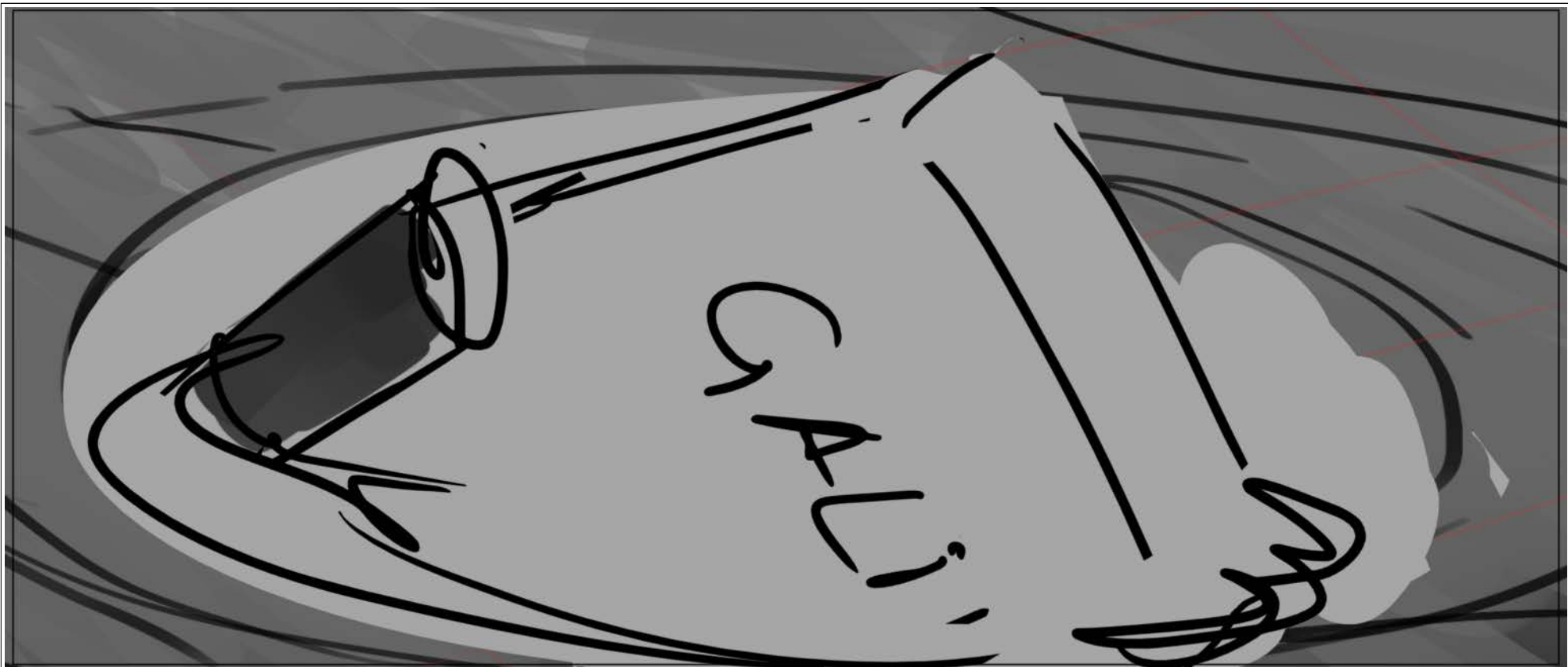

Scene	Duration	Panel	Duration
570A	02:00	002B	00:04

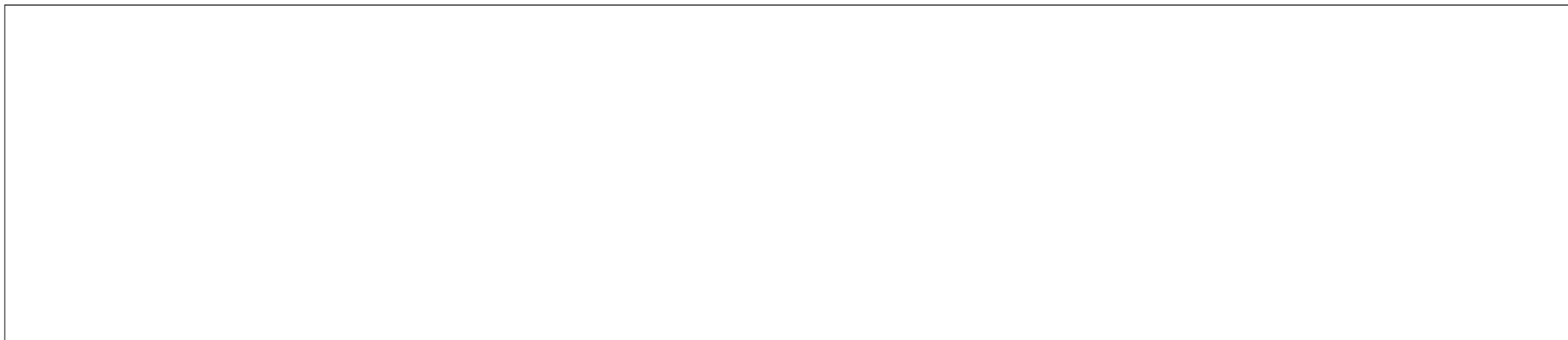
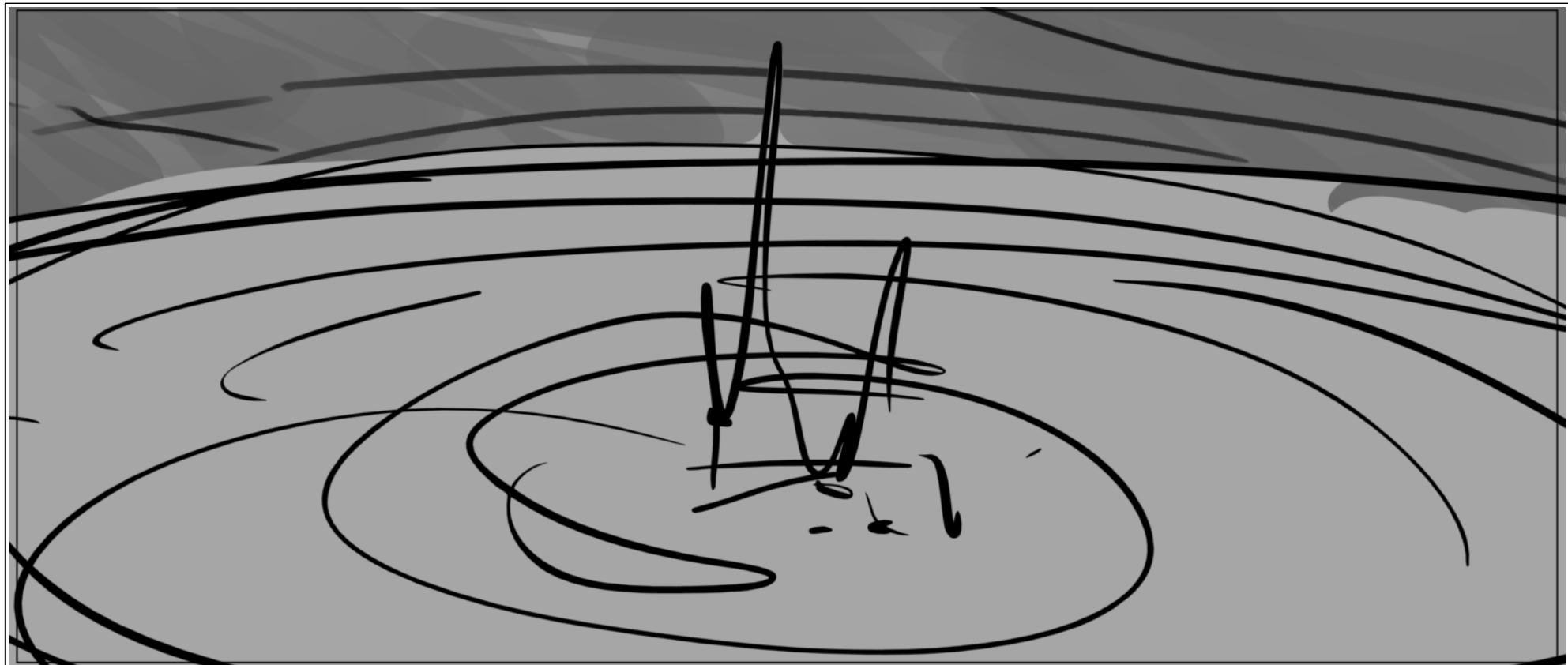

Scene	Duration	Panel	Duration
570A	02:00	002D	00:05

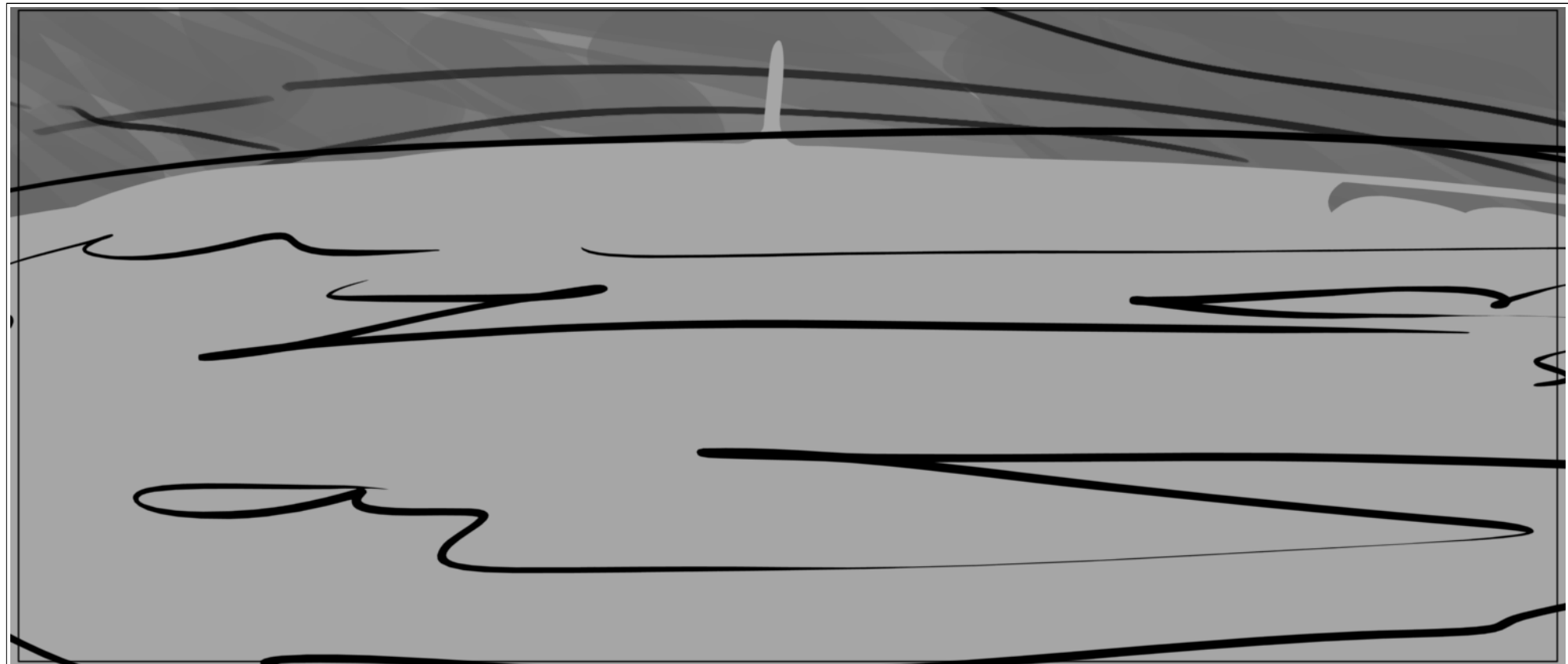

Scene	Duration	Panel	Duration
570A	02:00	002E	00:12

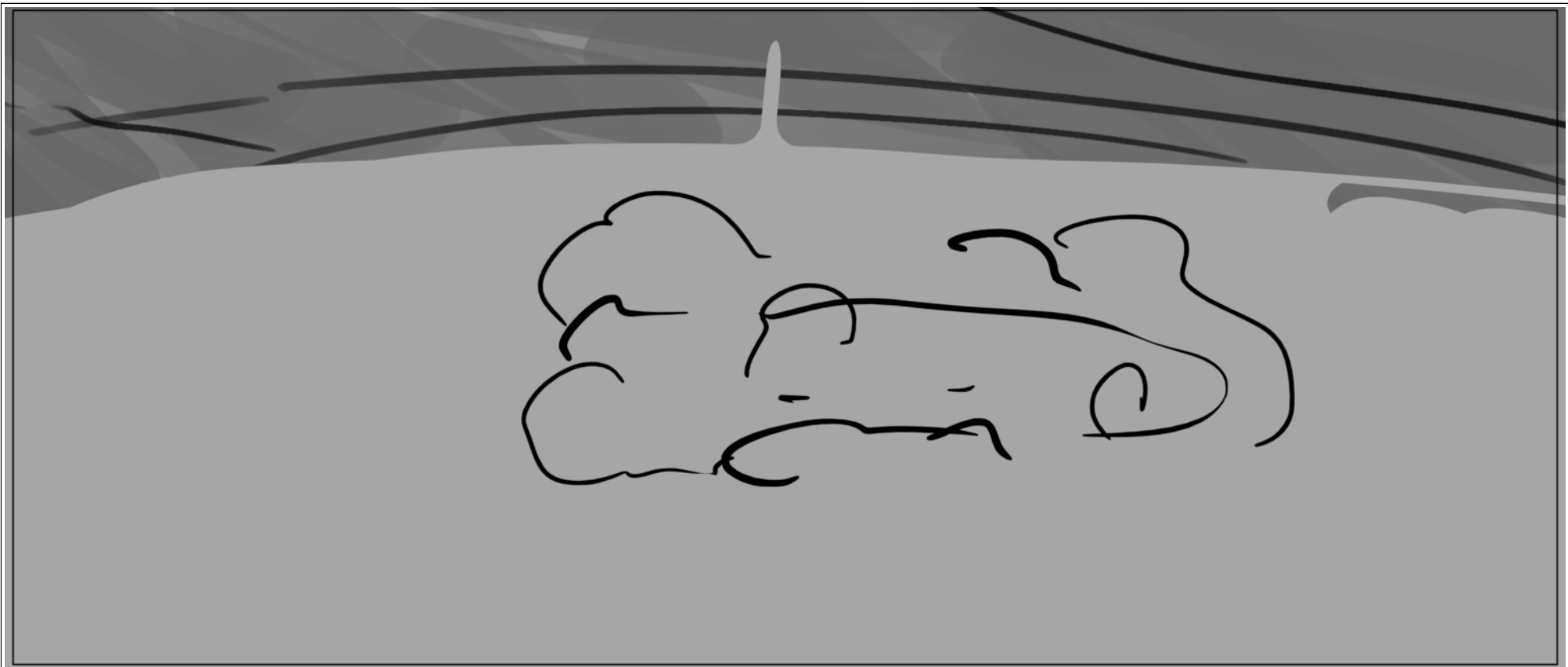

Scene	Duration	Panel	Duration
570A	02:00	001A1	00:01

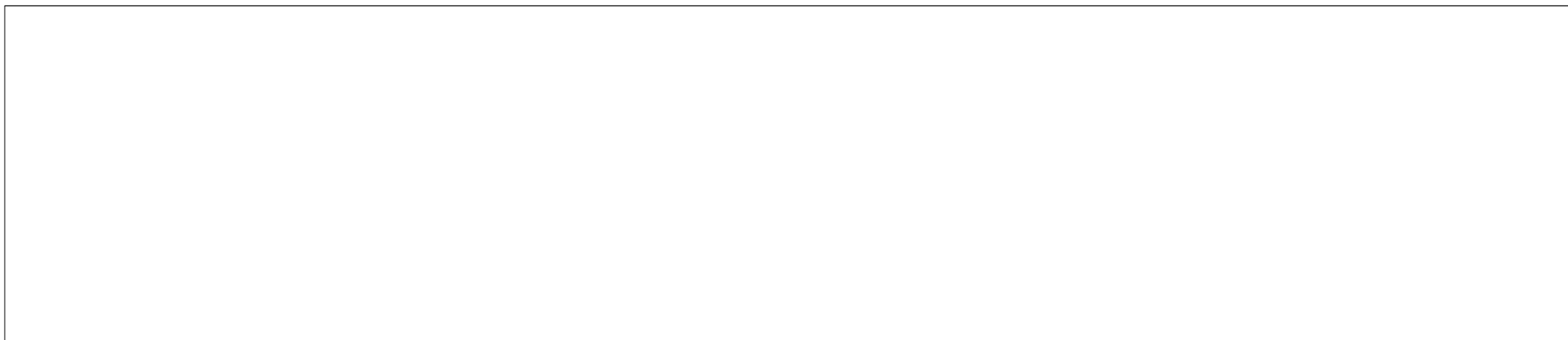

Scene	Duration	Panel	Duration
570A	02:00	001A2	00:01

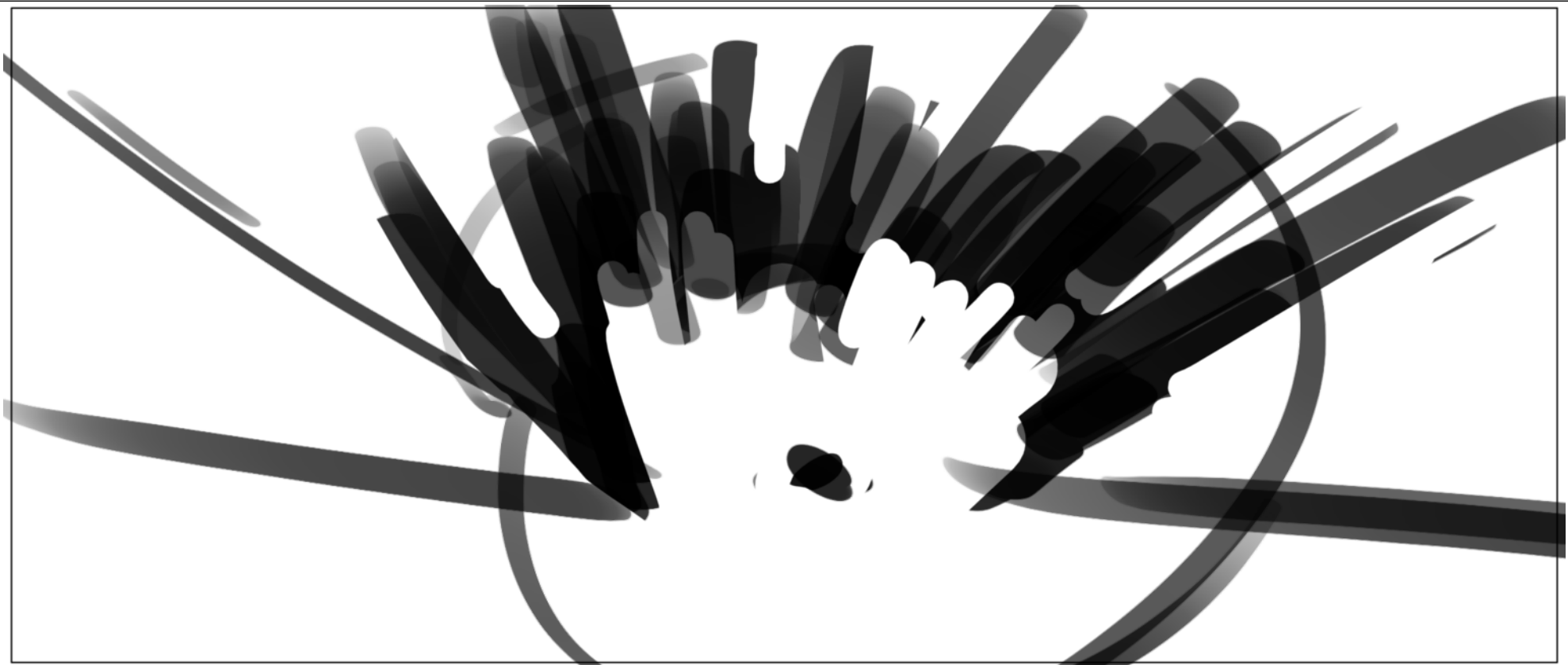

Scene	Duration	Panel	Duration
570A	02:00	001A3	00:01

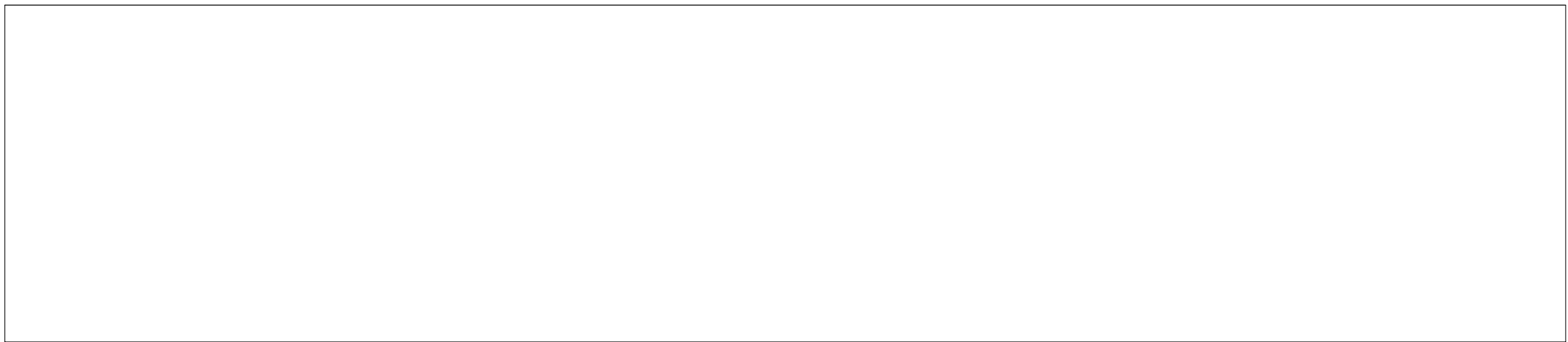
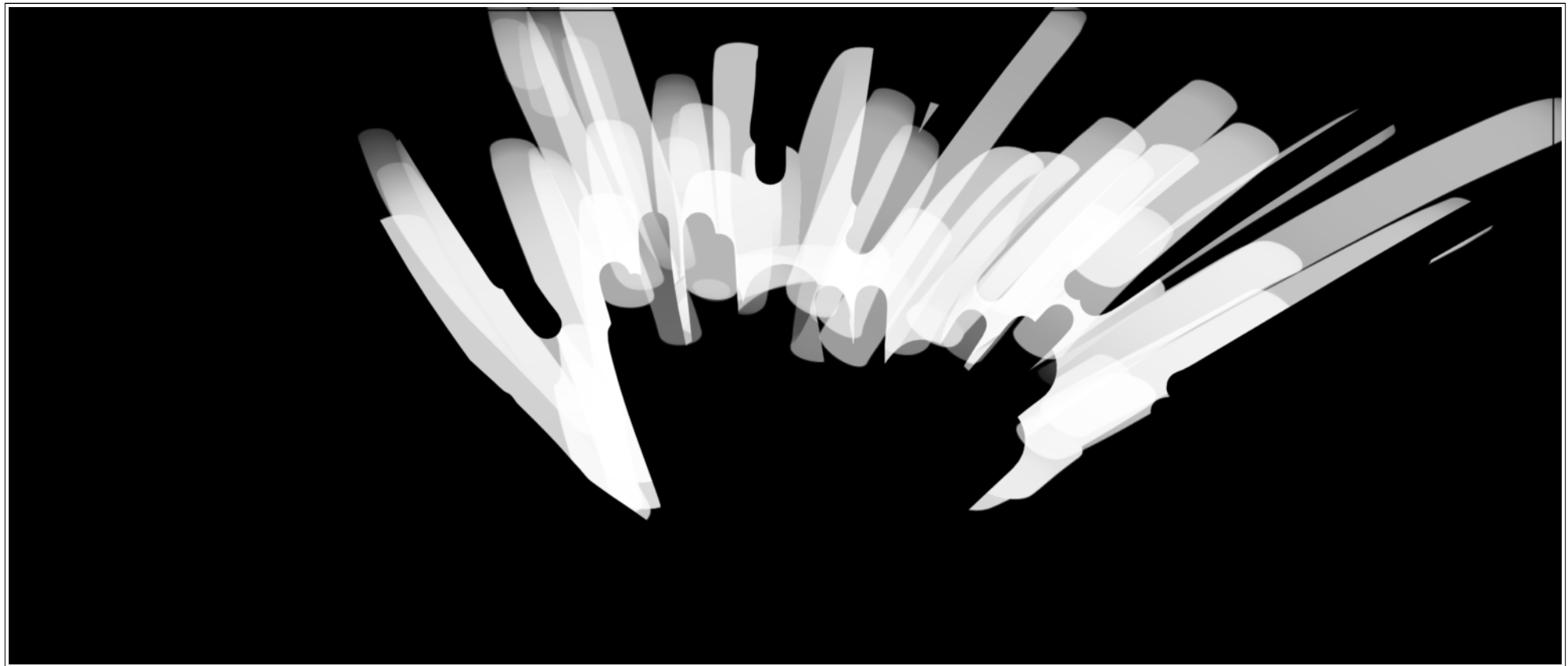

Scene	Duration	Panel	Duration
570A	02:00	001A0	00:02

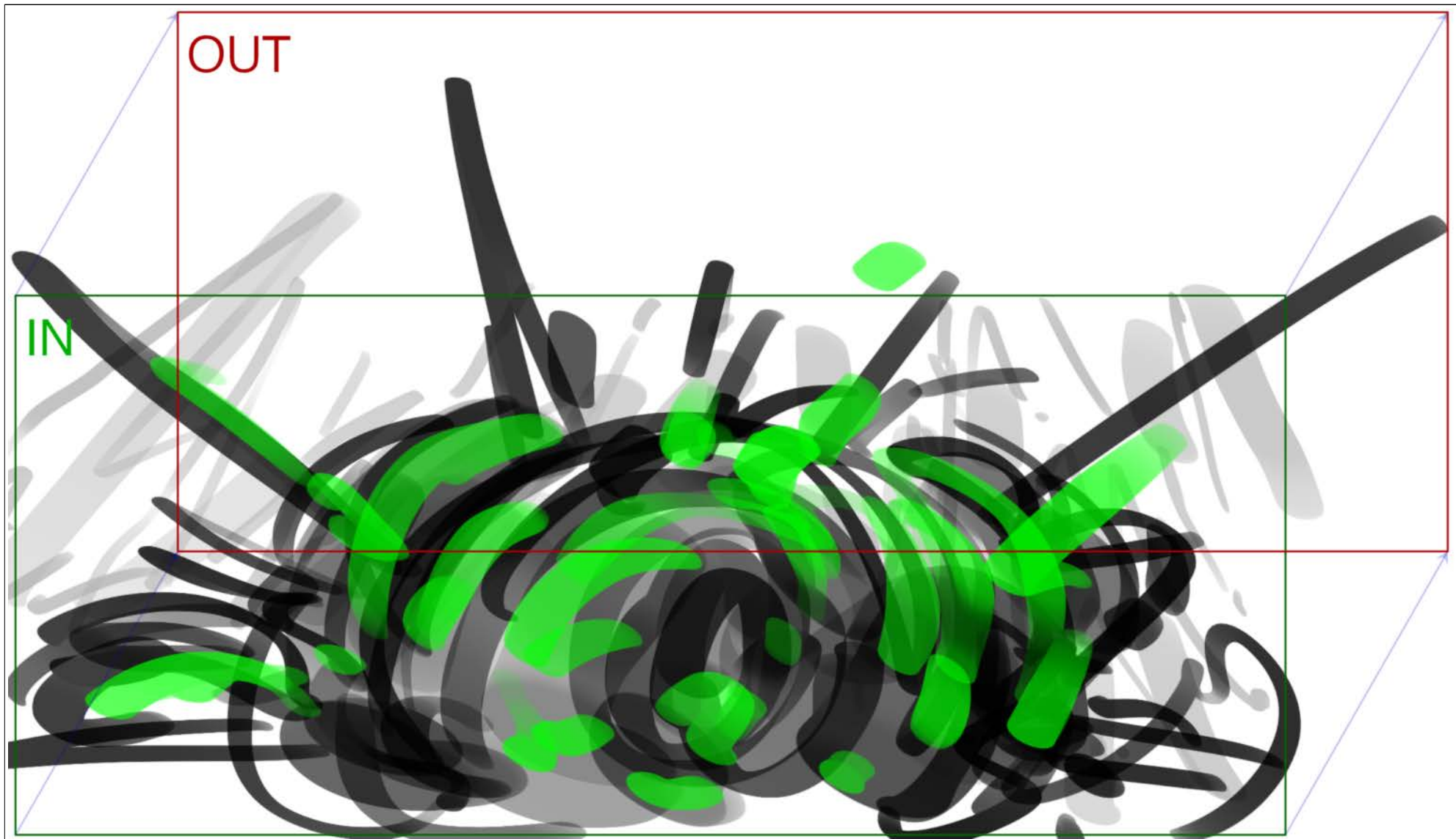

Scene	Duration	Panel	Duration
570A	02:00	001A	00:03

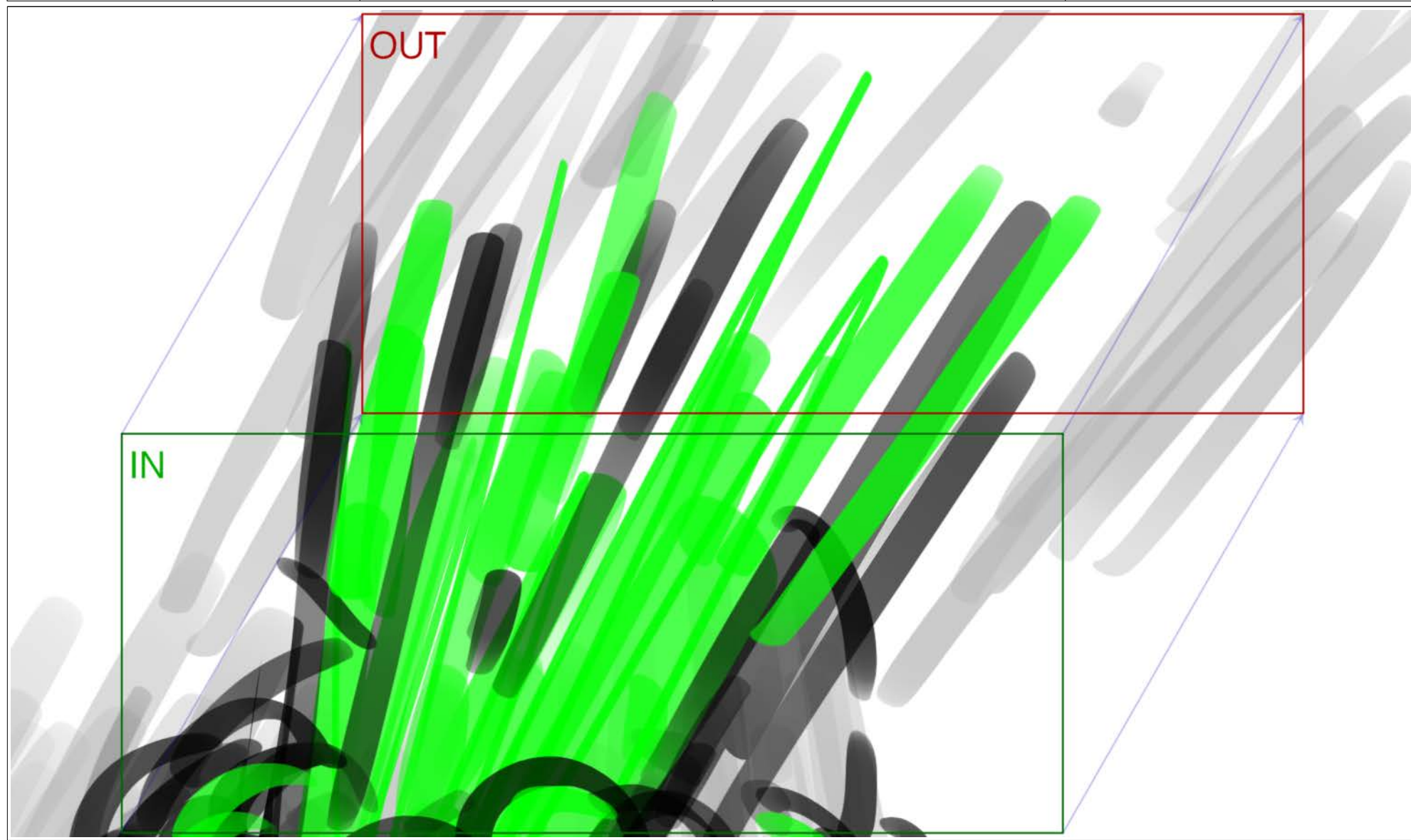

Action Notes
FLAMES BURSTS FROM PIT

Scene	Duration	Panel	Duration
570A	02:00	02A	00:02

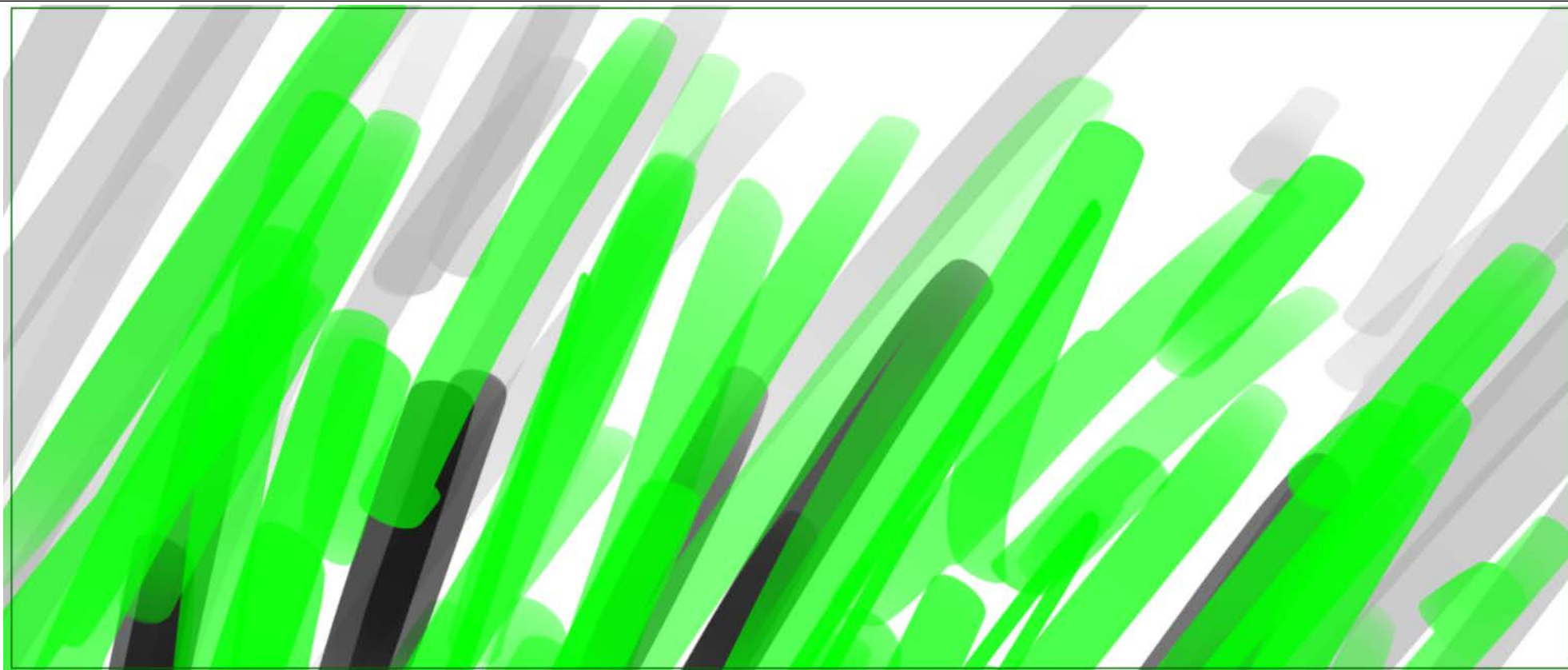

Action Notes

FLAMES BURSTS FROM PIT

Scene	Duration	Panel	Duration
580A	00:14	03B	00:14

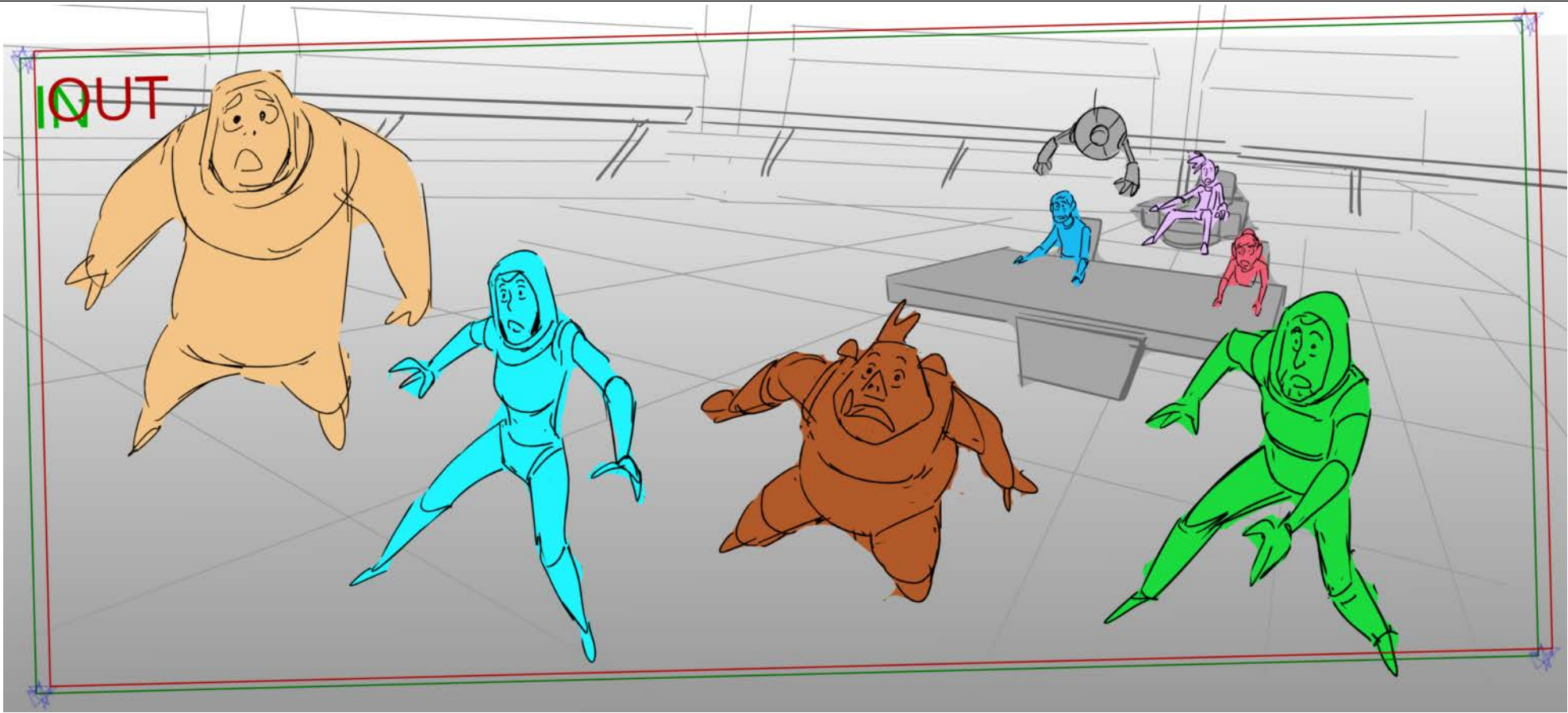

Scene	580AA	Duration	00:16	Panel	04B	Duration	00:07
-------	-------	----------	-------	-------	-----	----------	-------

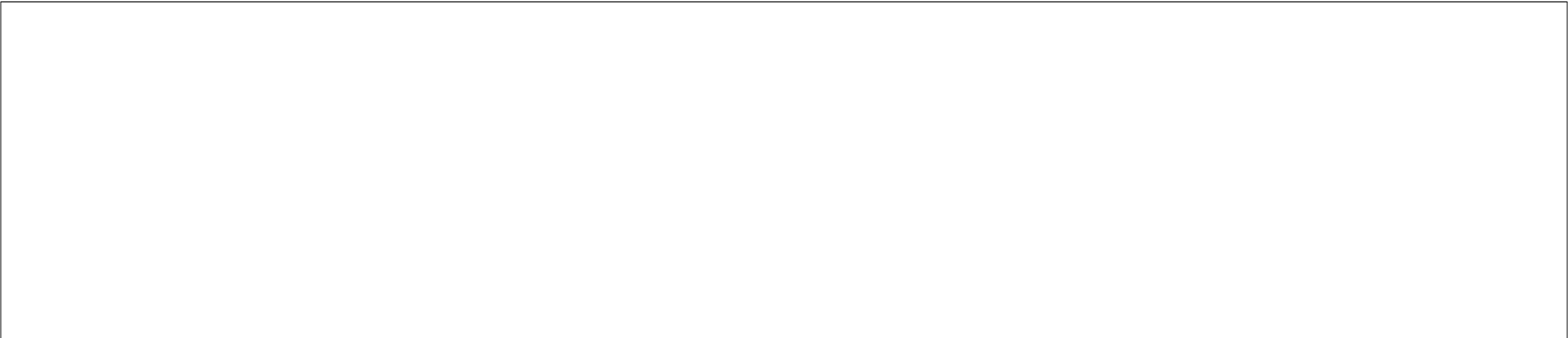

Scene	Duration	Panel	Duration
580AA	00:16	05B	00:09



Dialog

DAL

SHIELDS UP!

Scene	Duration	Panel	Duration
580	00:08	03A	00:03

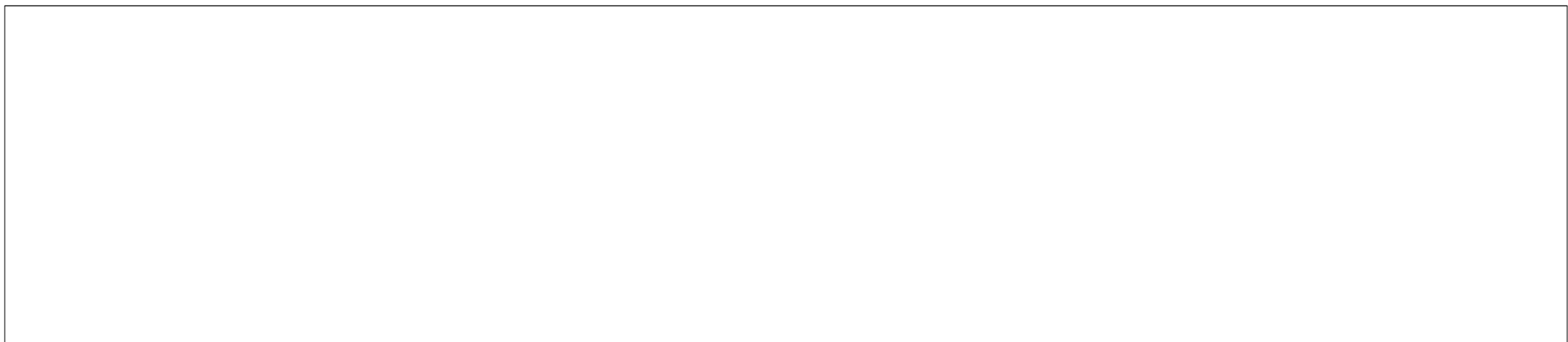
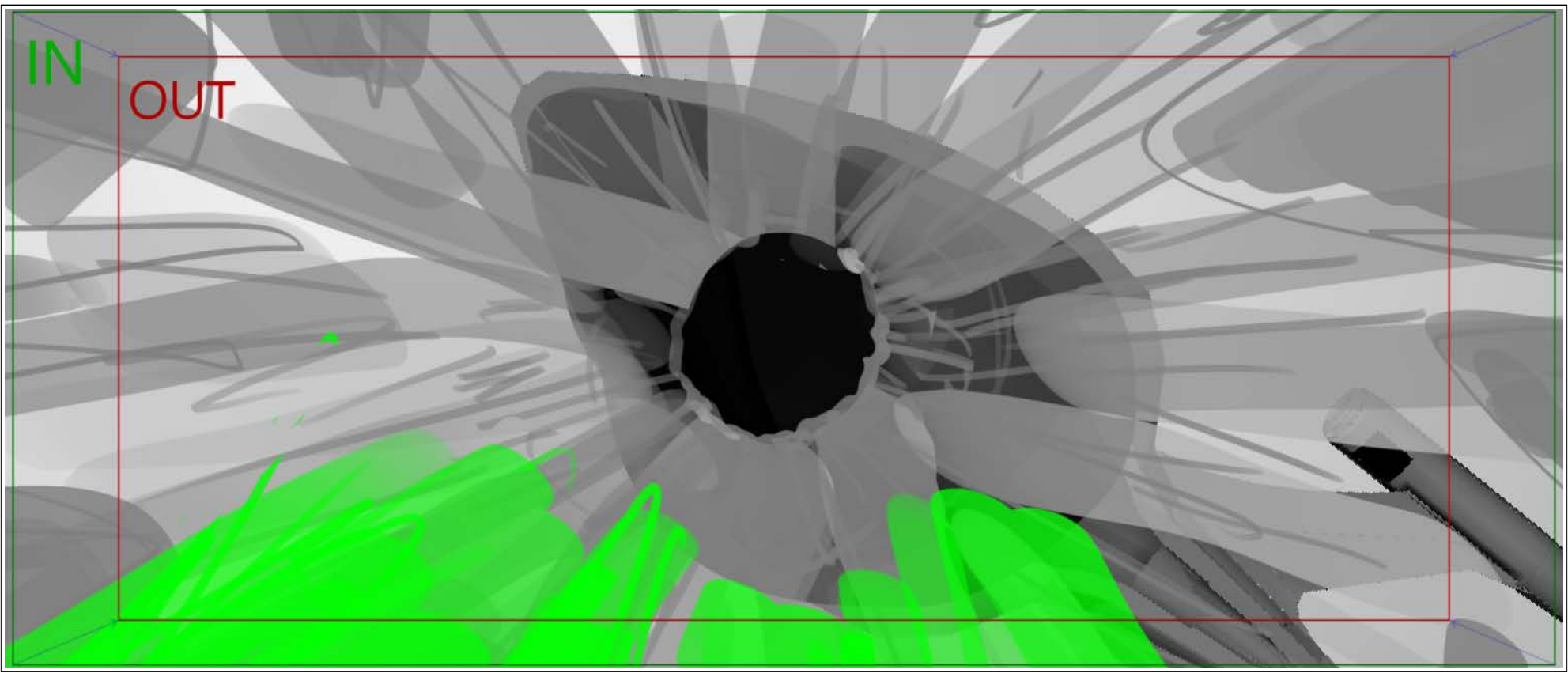

Scene	Duration	Panel	Duration
580	00:08	04A	00:05

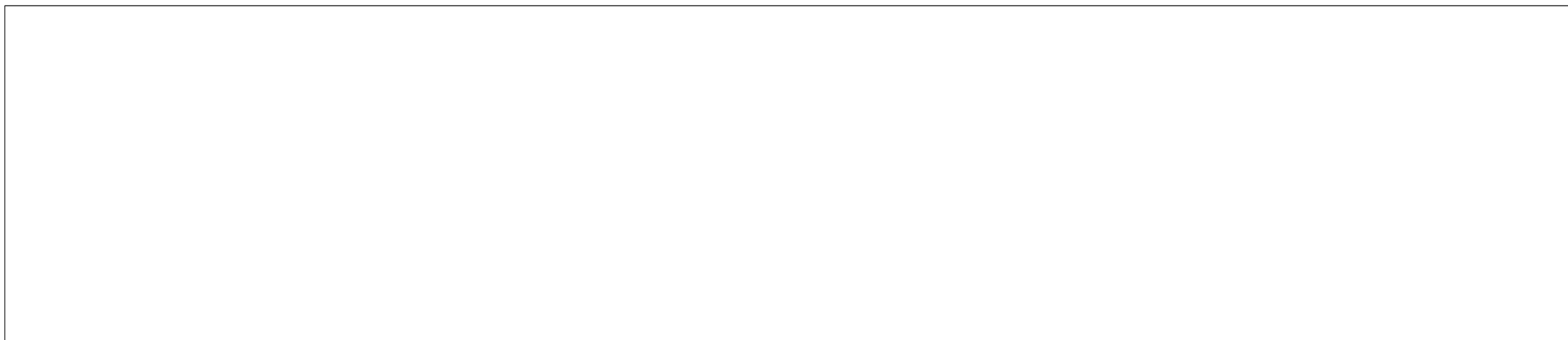
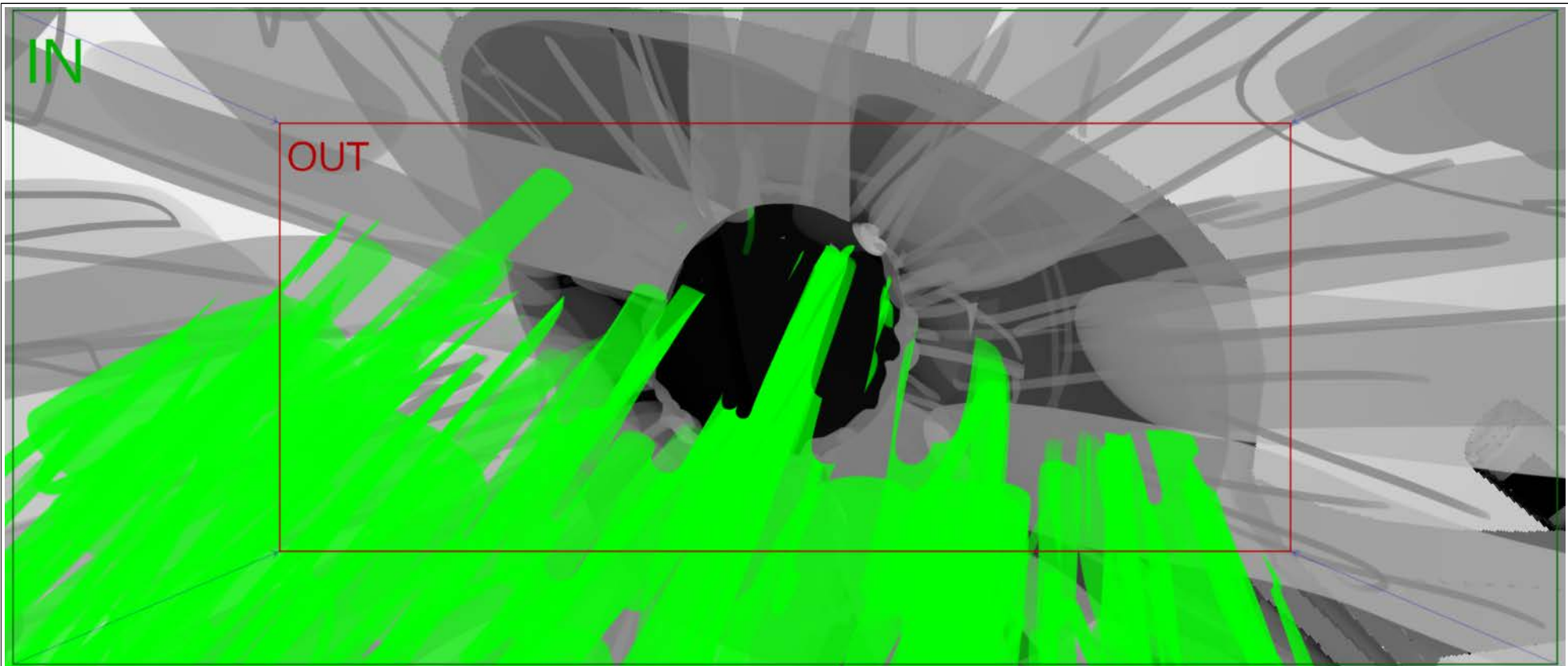

Scene	Duration	Panel	Duration
590	00:23	001	00:06

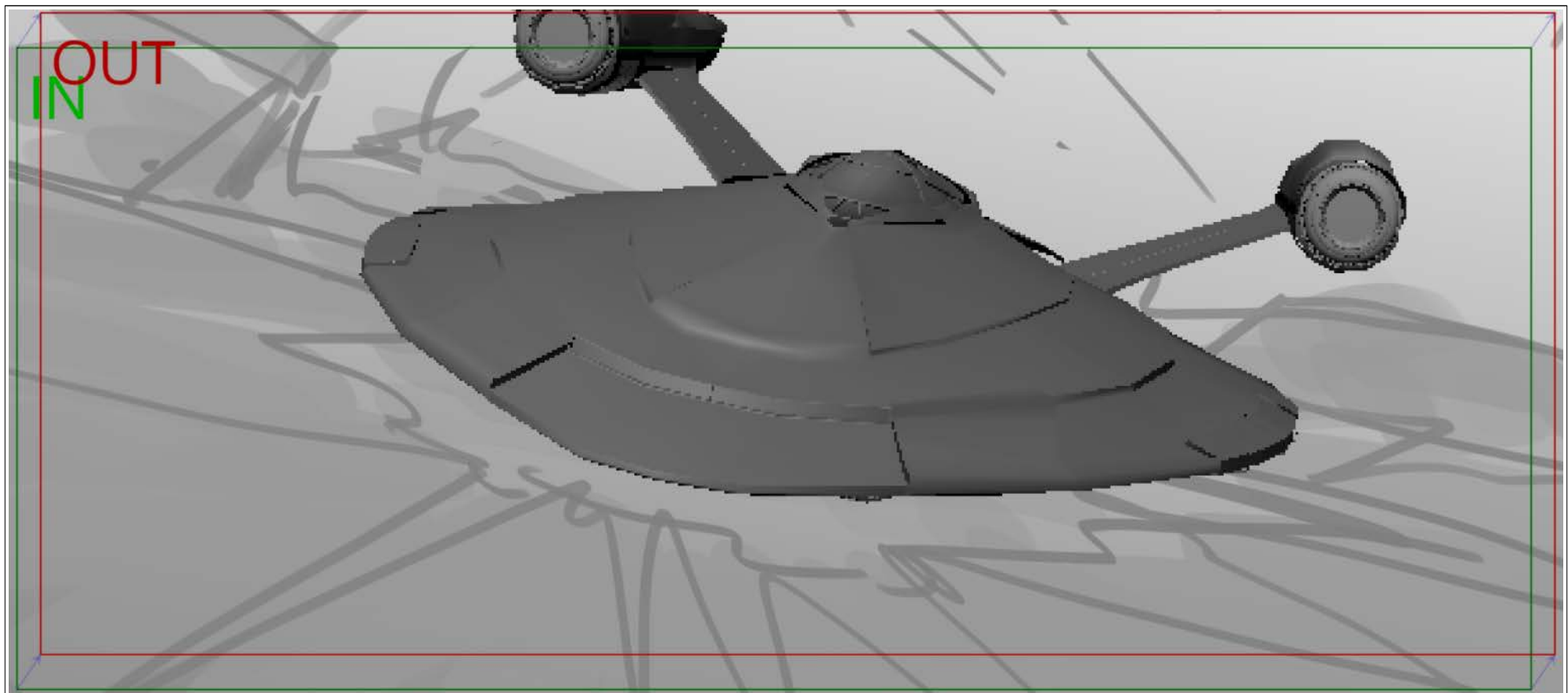

Scene	Duration	Panel	Duration
590	00:23	002	00:04

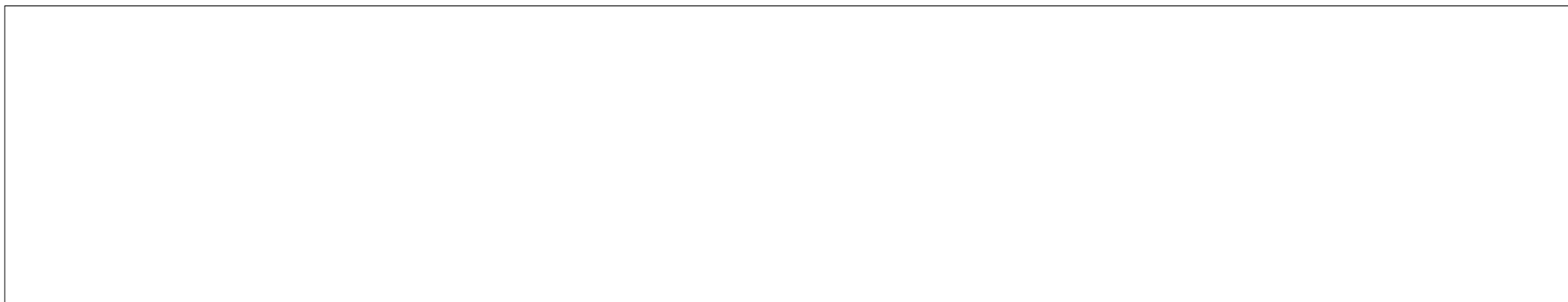
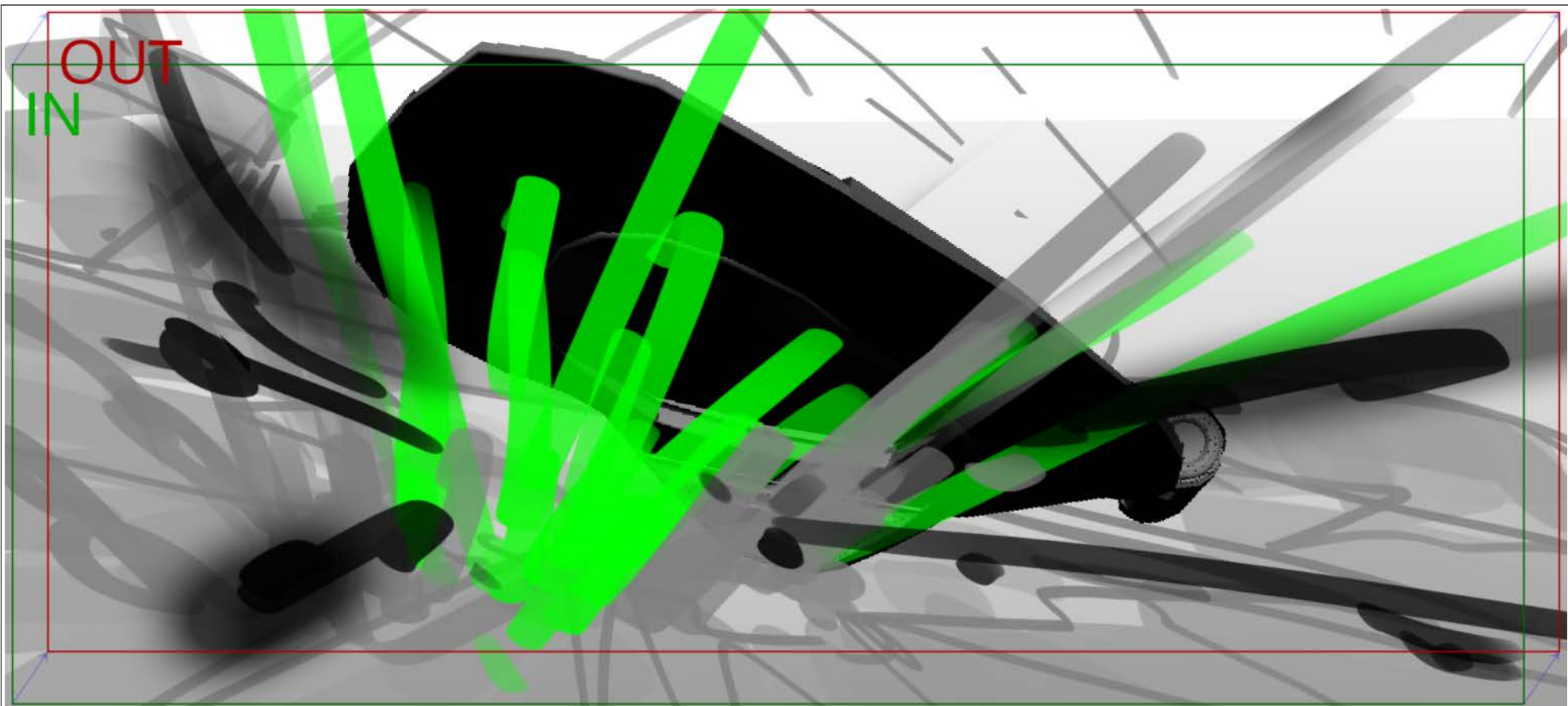

Scene	Duration	Panel	Duration
590	00:23	003	00:05

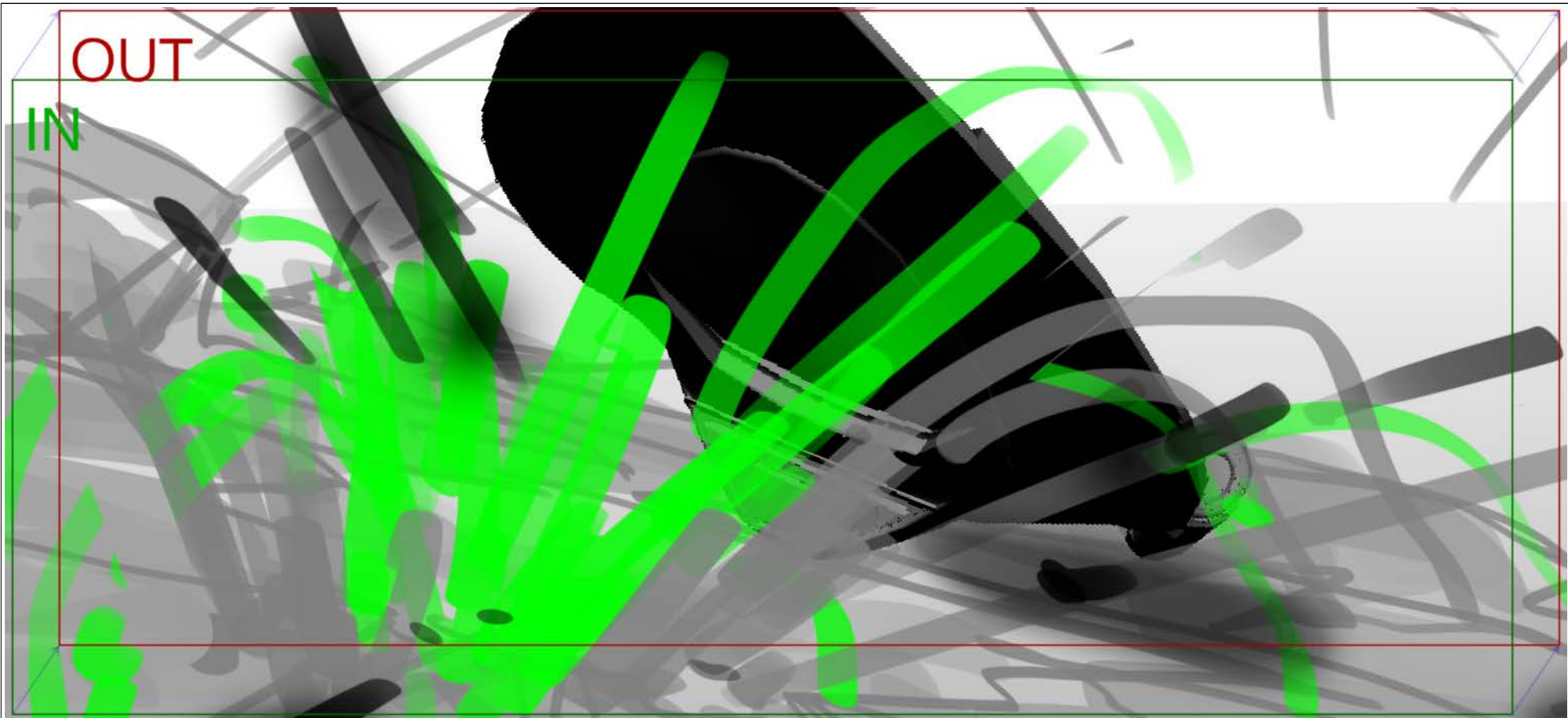

Scene	Duration	Panel	Duration
590	00:23	004	00:08

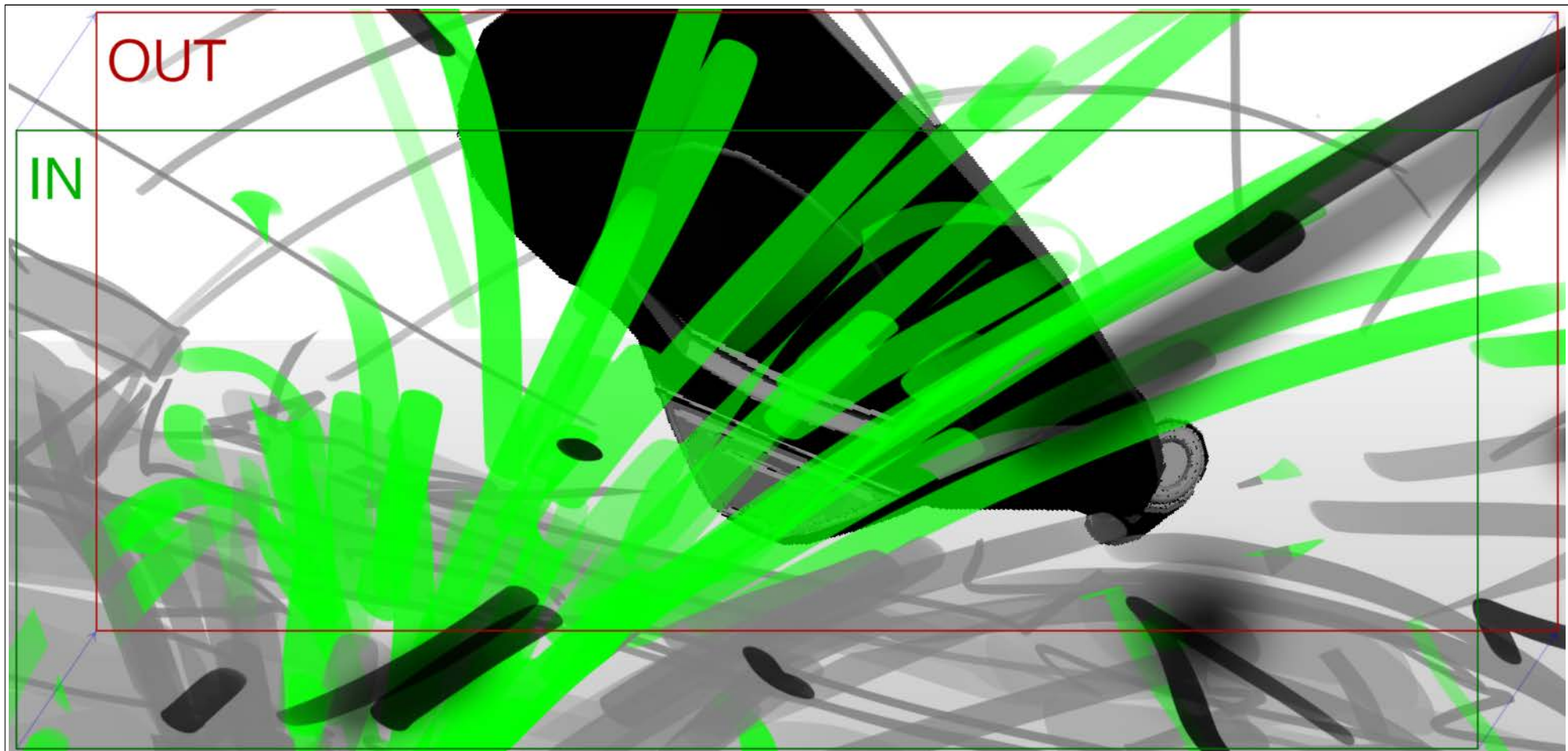

Scene	Duration	Panel	Duration
600	01:03	001	00:05

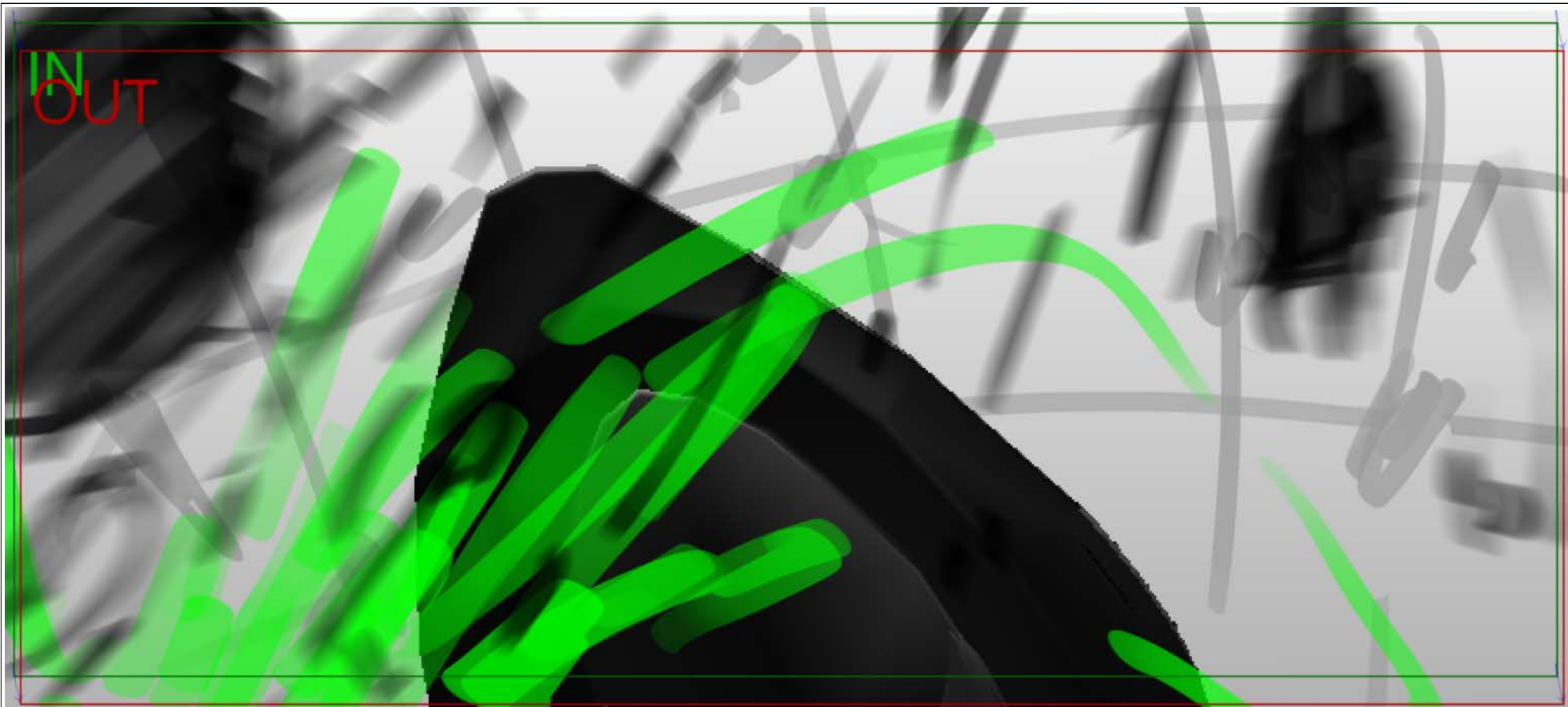

Action Notes

ROCKS AND CRYSTALS BEGIN TO FALL AND CAVE COLLAPSES

Scene	Duration	Panel	Duration
600	01:03	002	00:06

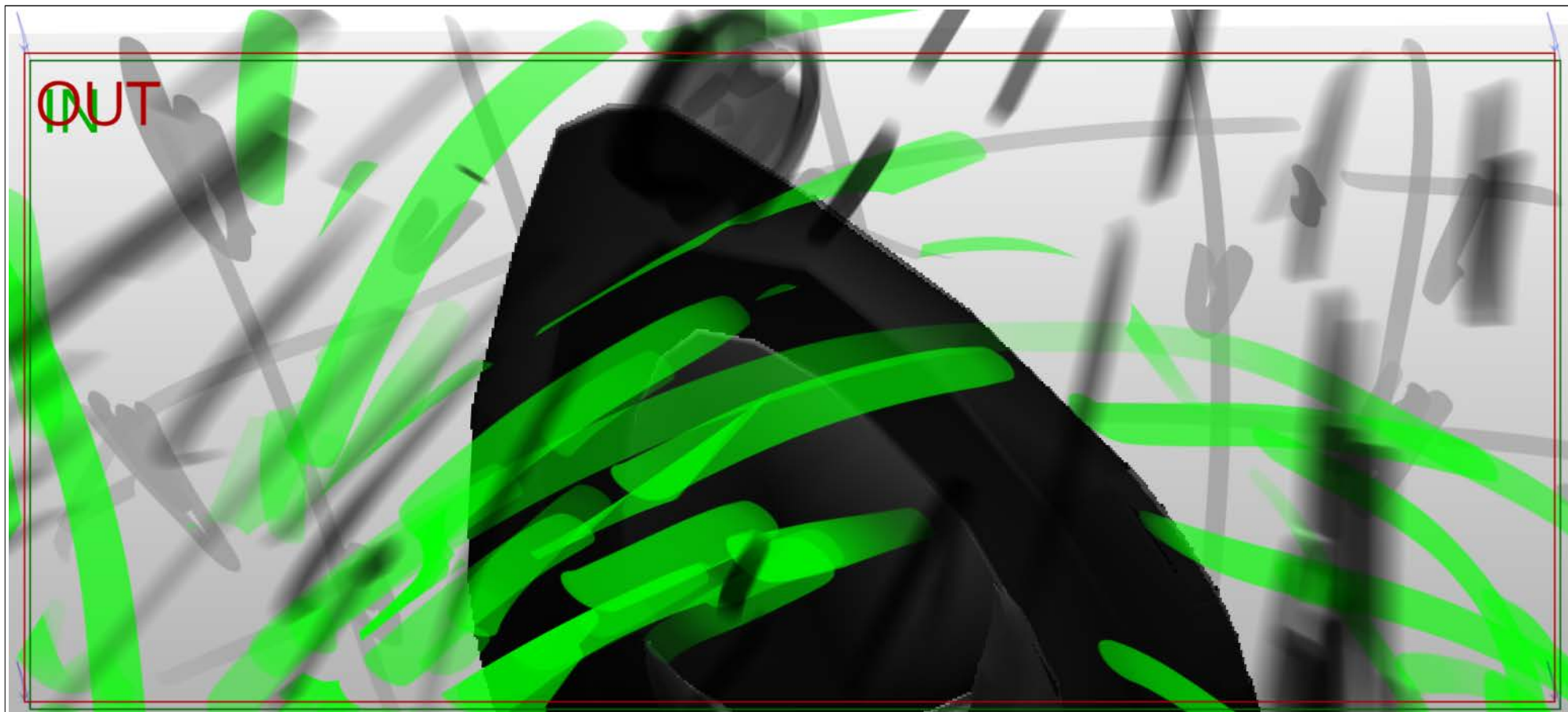

Action Notes

ROCKS AND CRYSTALS BEGIN TO FALL AND CAVE COLLAPSES

Scene	Duration	Panel	Duration
600	01:03	003	00:06

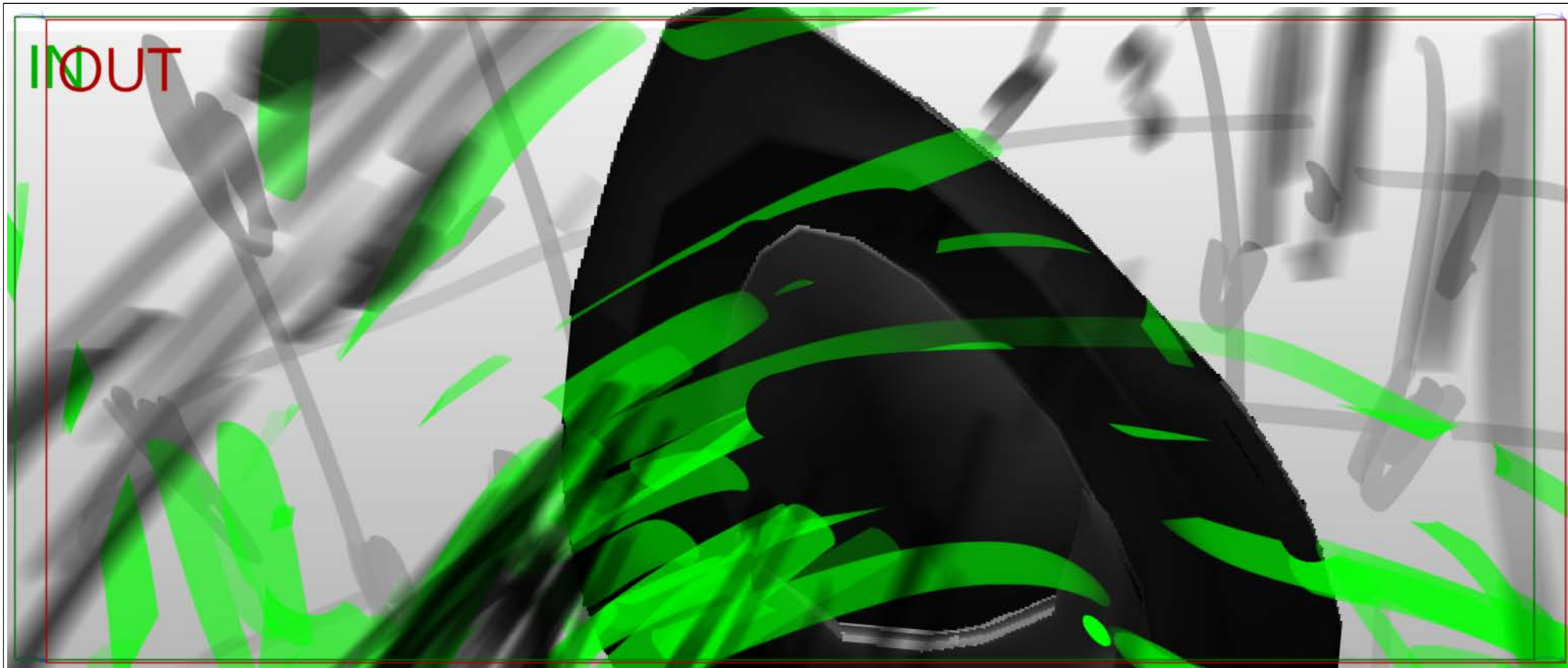

Action Notes

ROCKS AND CRYSTALS BEGIN TO FALL AND CAVE COLLAPSES

Scene	Duration	Panel	Duration
600	01:03	004	00:10

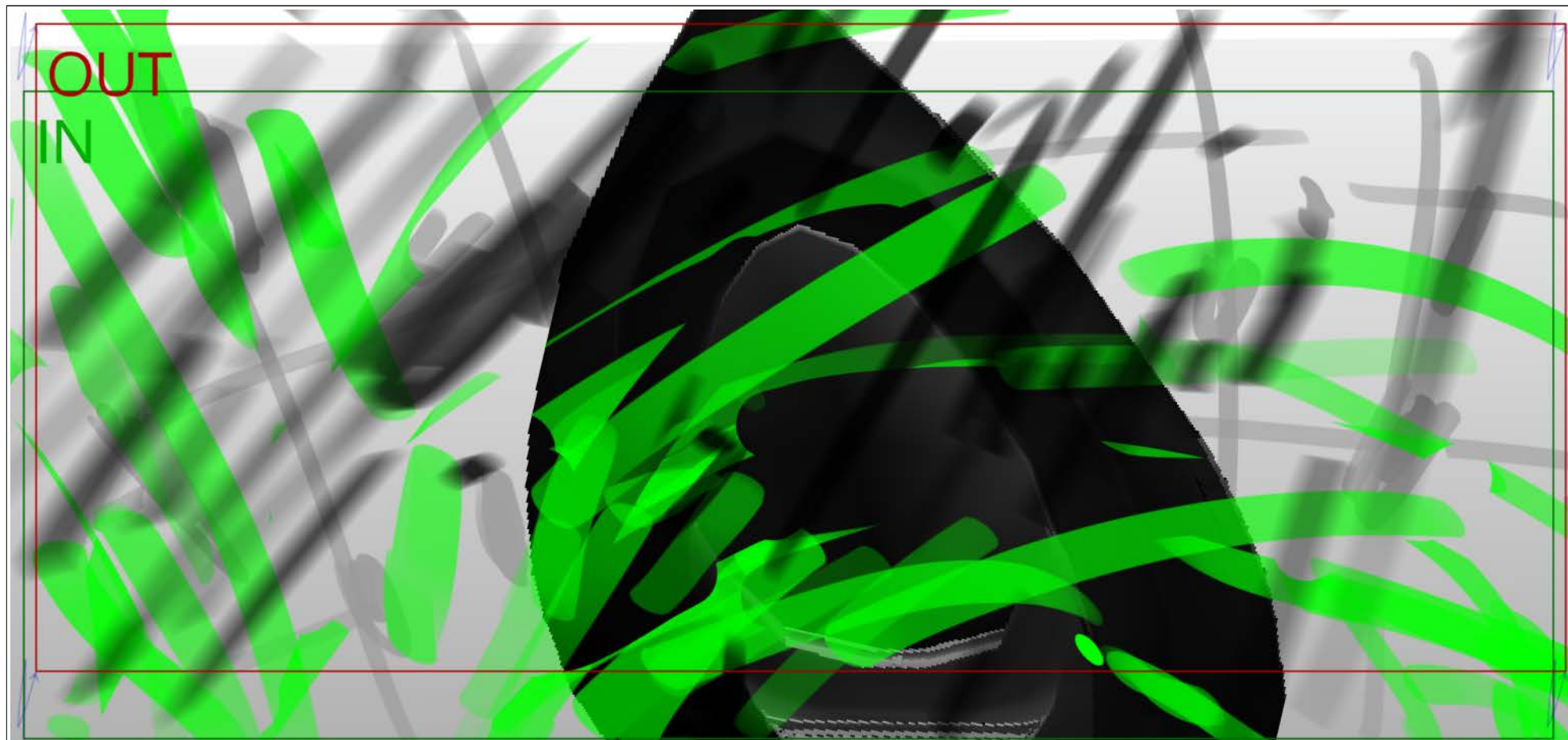

Action Notes

ROCKS AND CRYSTALS BEGIN TO FALL AND CAVE COLLAPSES

Scene	Duration	Panel	Duration
620	02:01	001	00:05

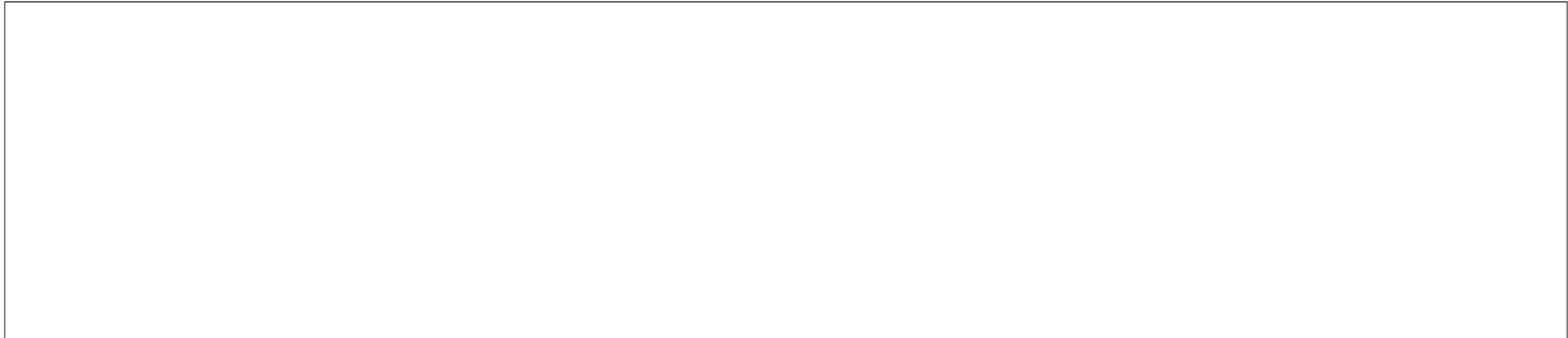
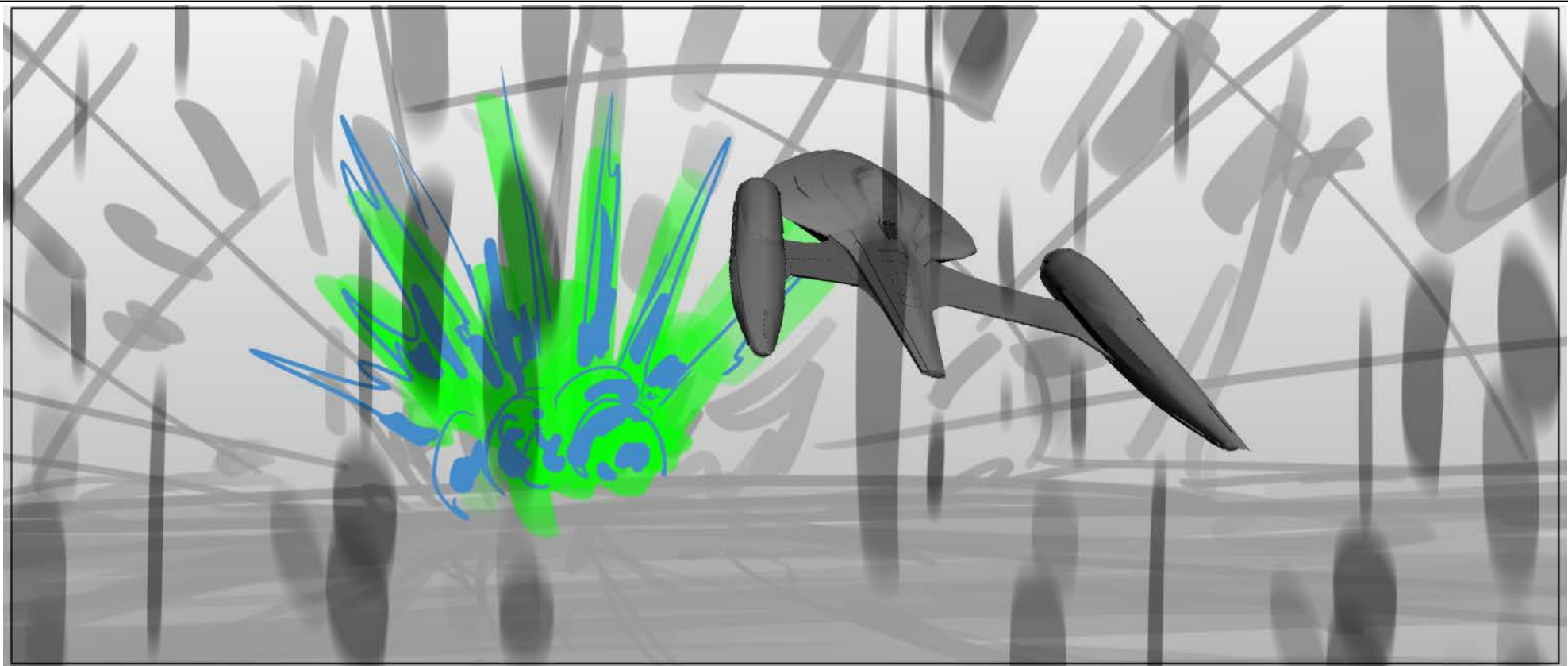

Scene	Duration	Panel	Duration
620	02:01	001A0	00:06

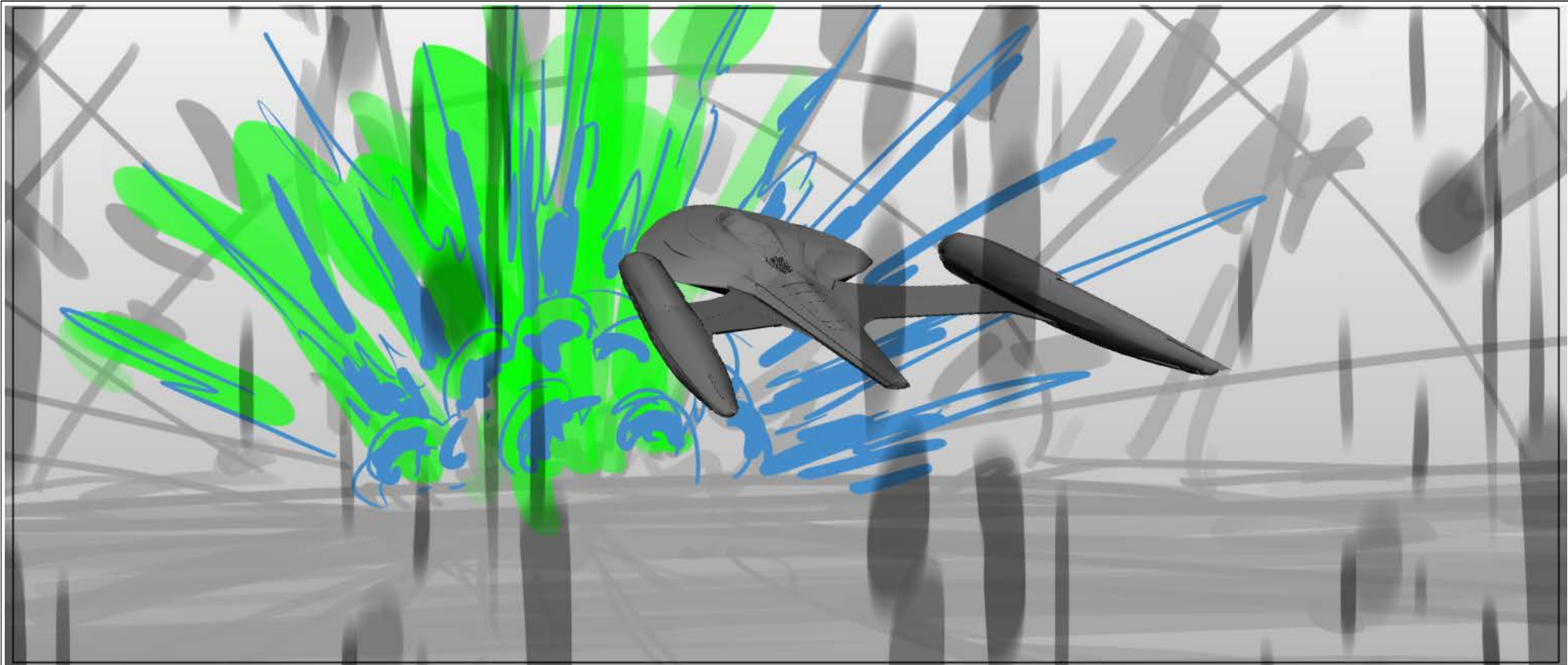

Scene	Duration	Panel	Duration
620	02:01	001A	00:04

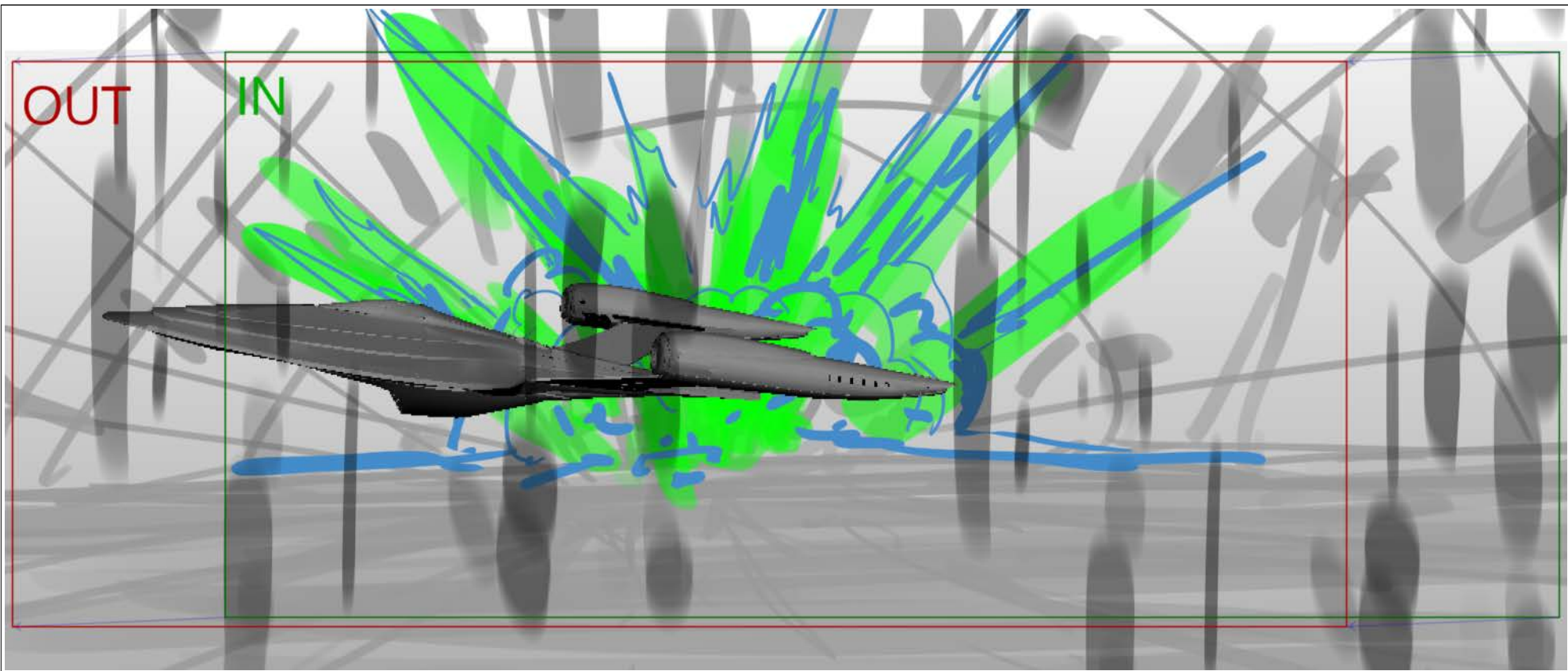

Scene	Duration	Panel	Duration
620	02:01	001X	00:04

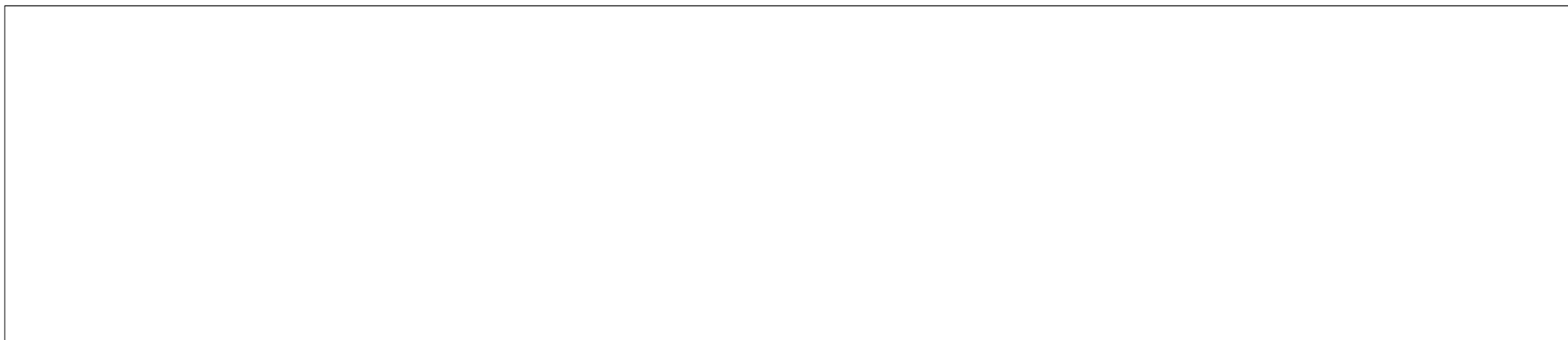
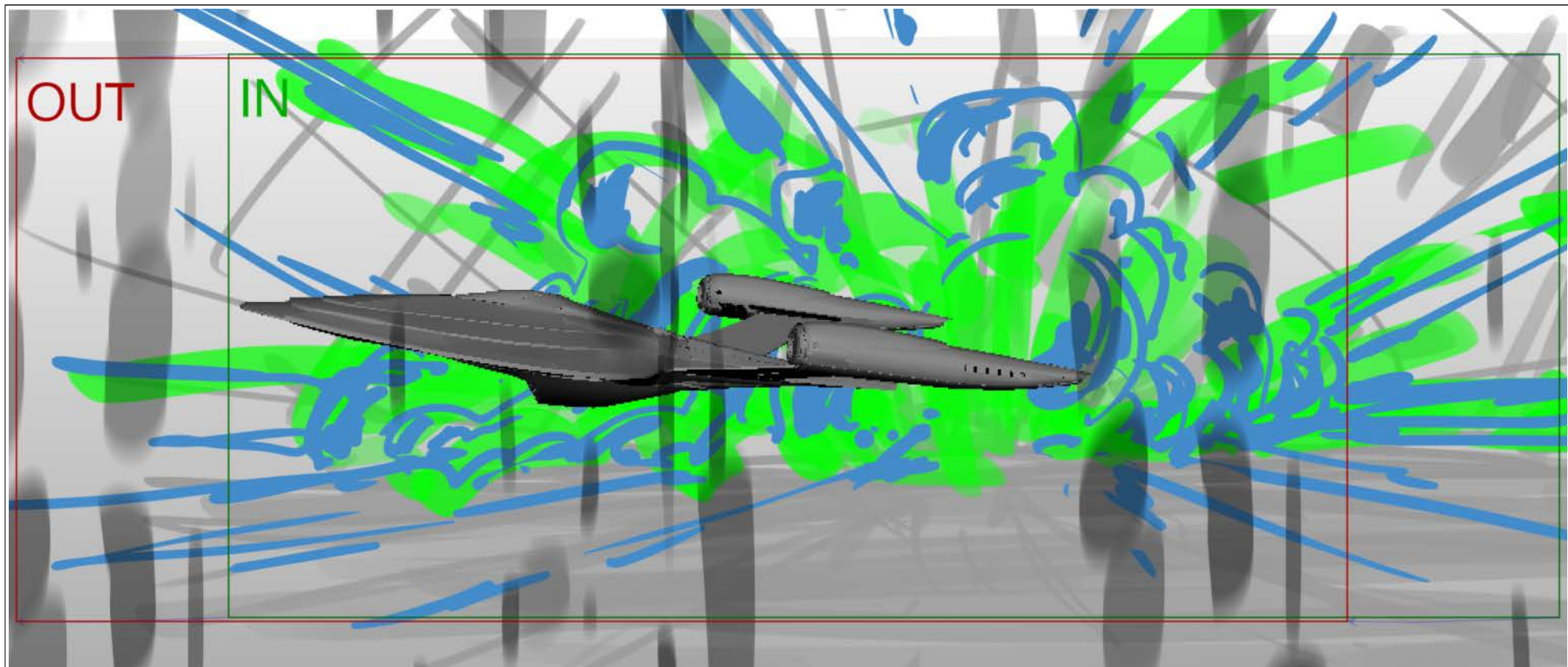

Scene	Duration	Panel	Duration
620	02:01	001B	00:06

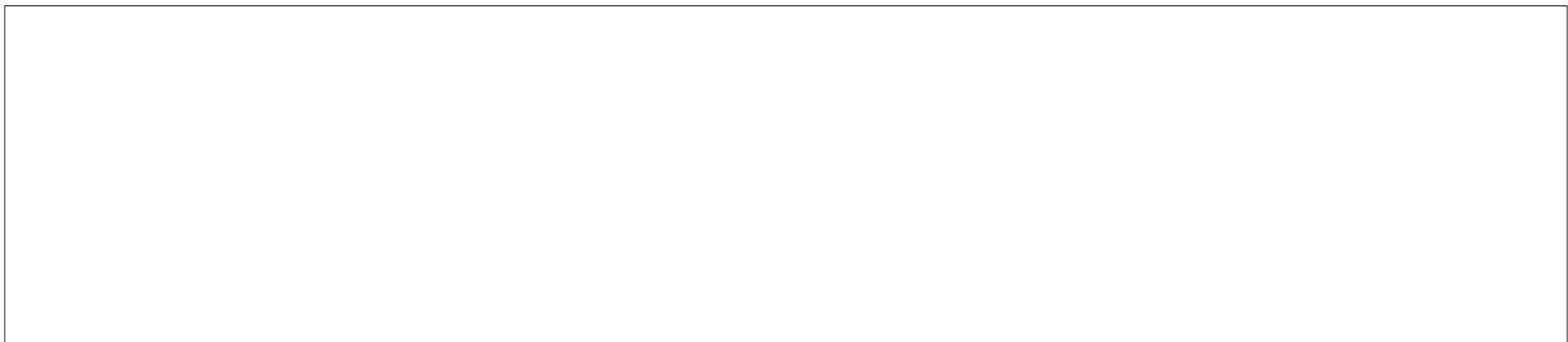
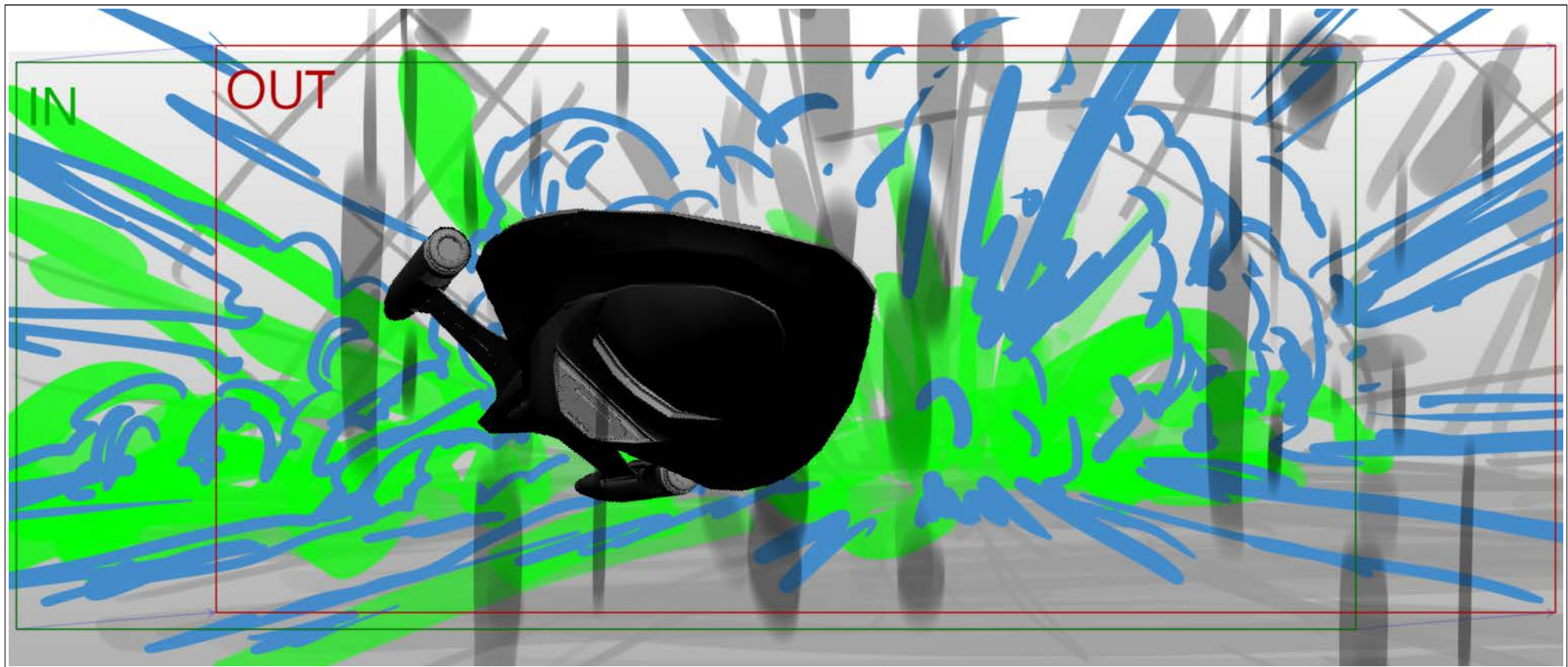

Scene	Duration	Panel	Duration
620	02:01	001Y	00:06

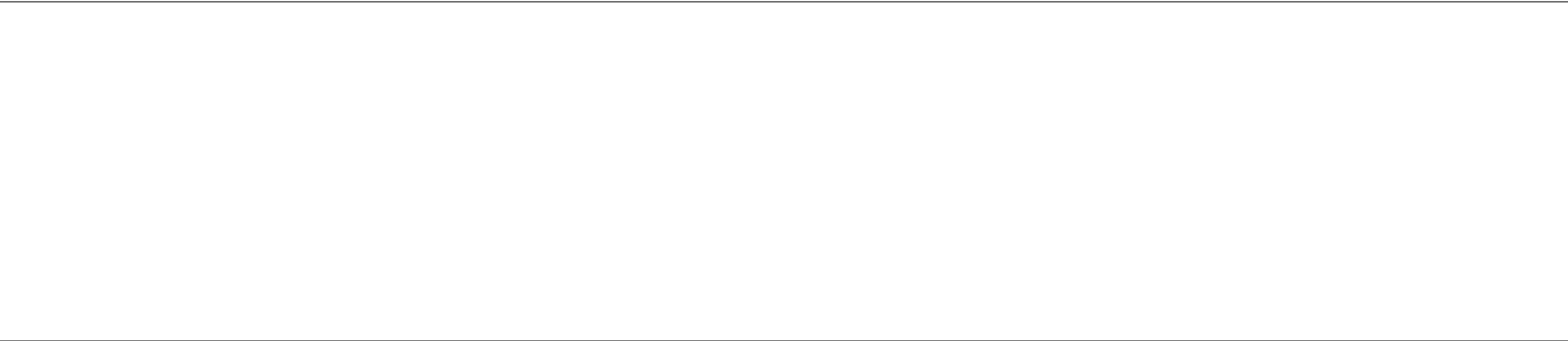
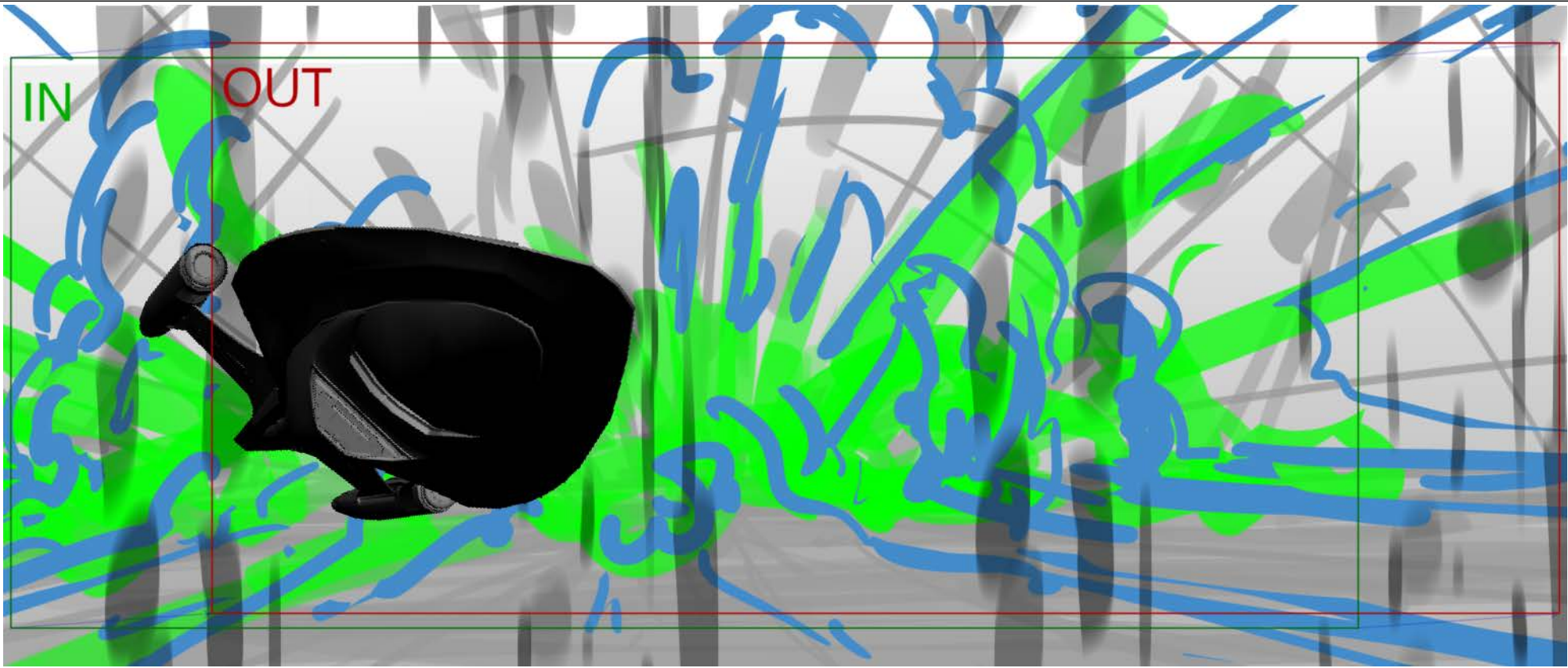

Scene	Duration	Panel	Duration
620	02:01	001C	00:06

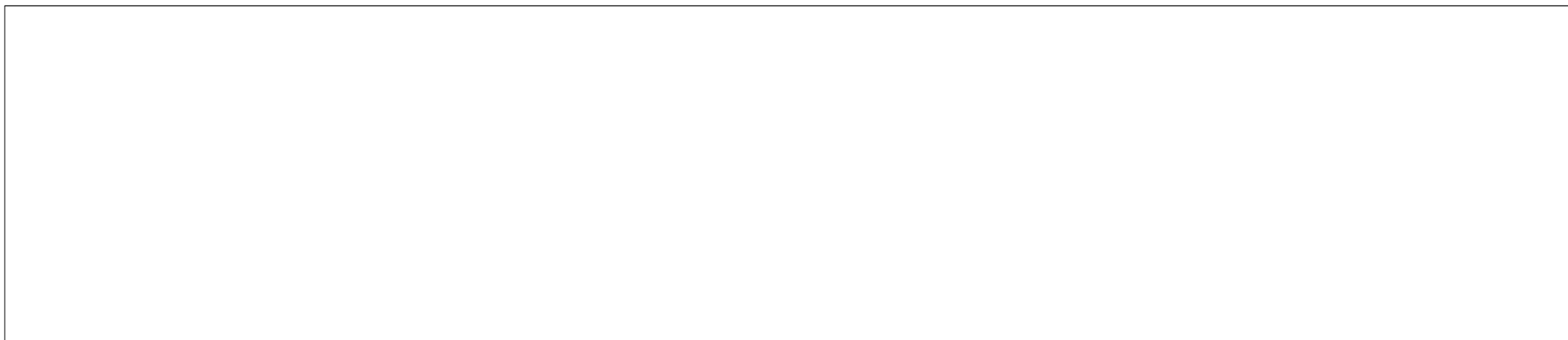
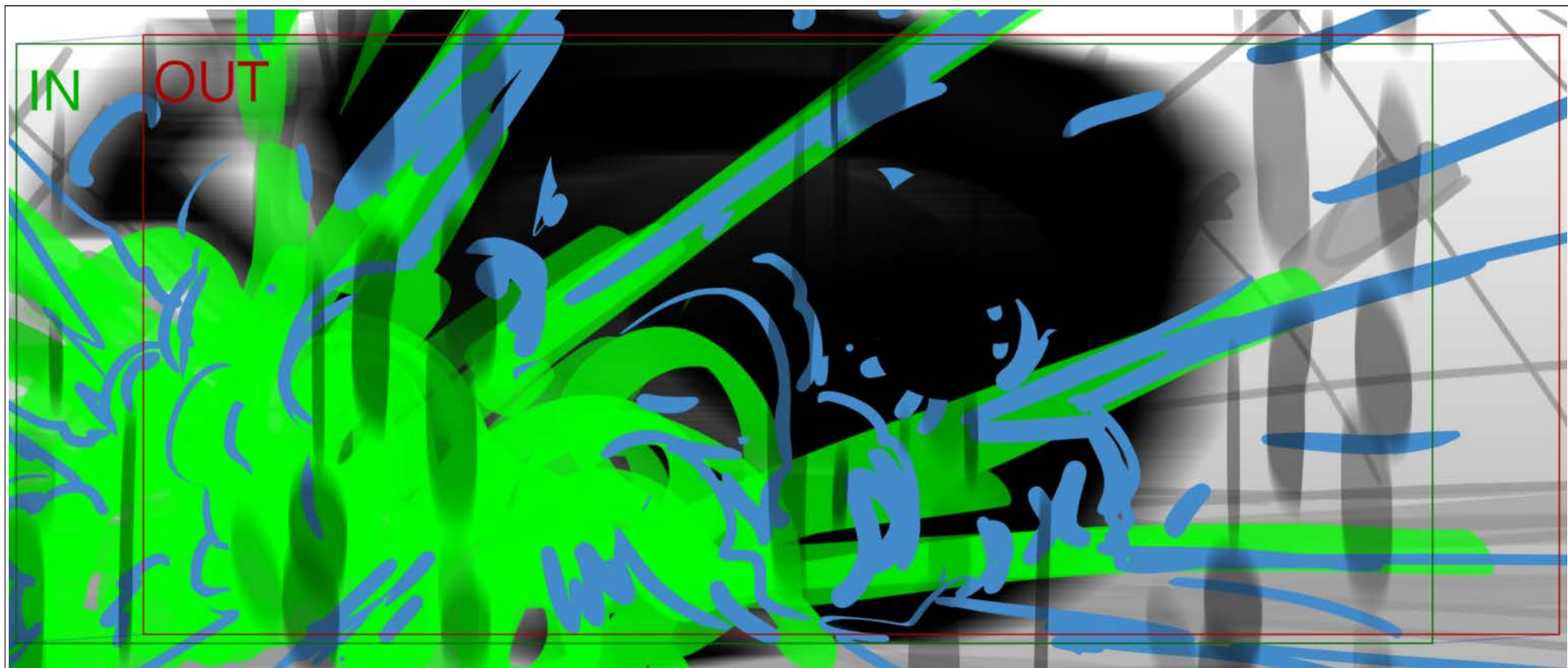

Scene	Duration	Panel	Duration
620	02:01	001D	00:06



Scene	Duration	Panel	Duration
620	02:01	001E	00:06

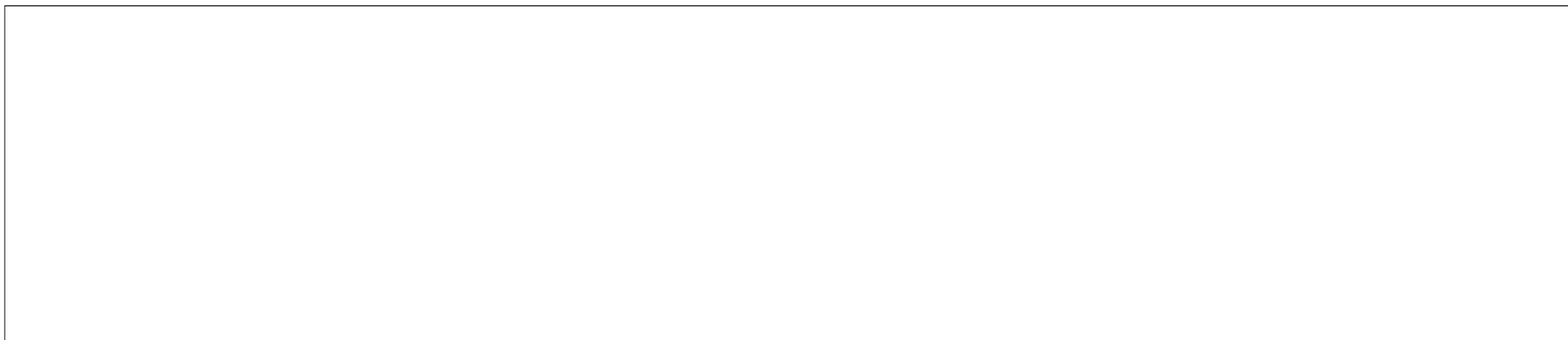
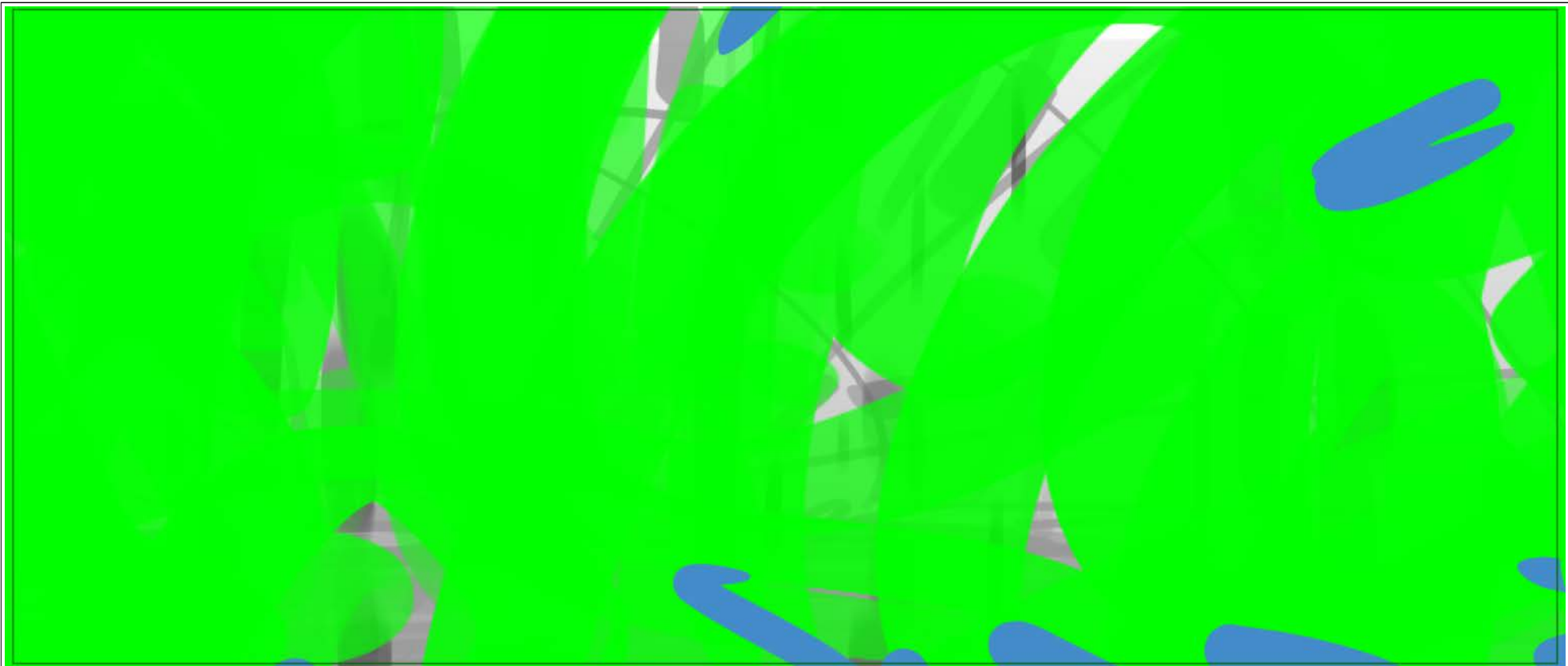

Scene	Duration	Panel	Duration
660	02:12	001	00:12

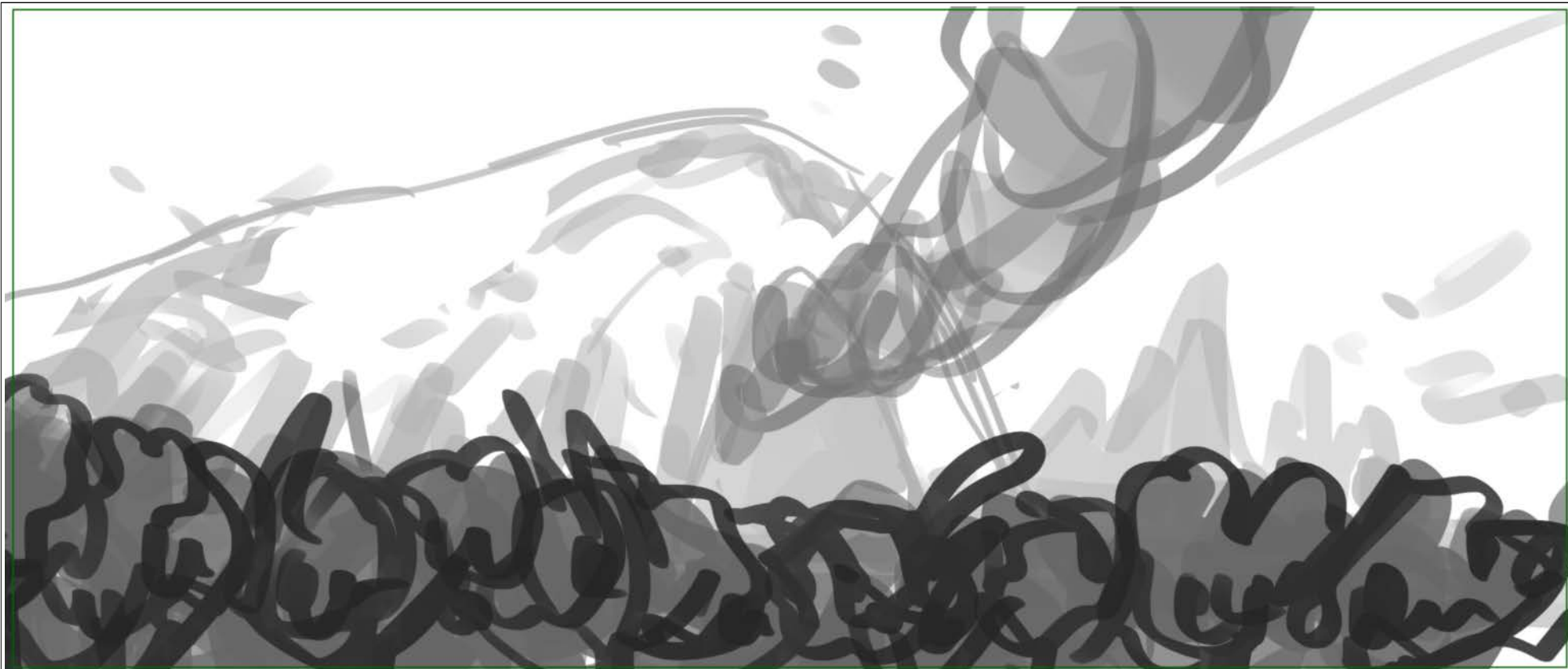

Action Notes

EXT. SHOT OF CAVE COLLAPSING

Scene	Duration	Panel	Duration
660	02:12	001A0	00:05

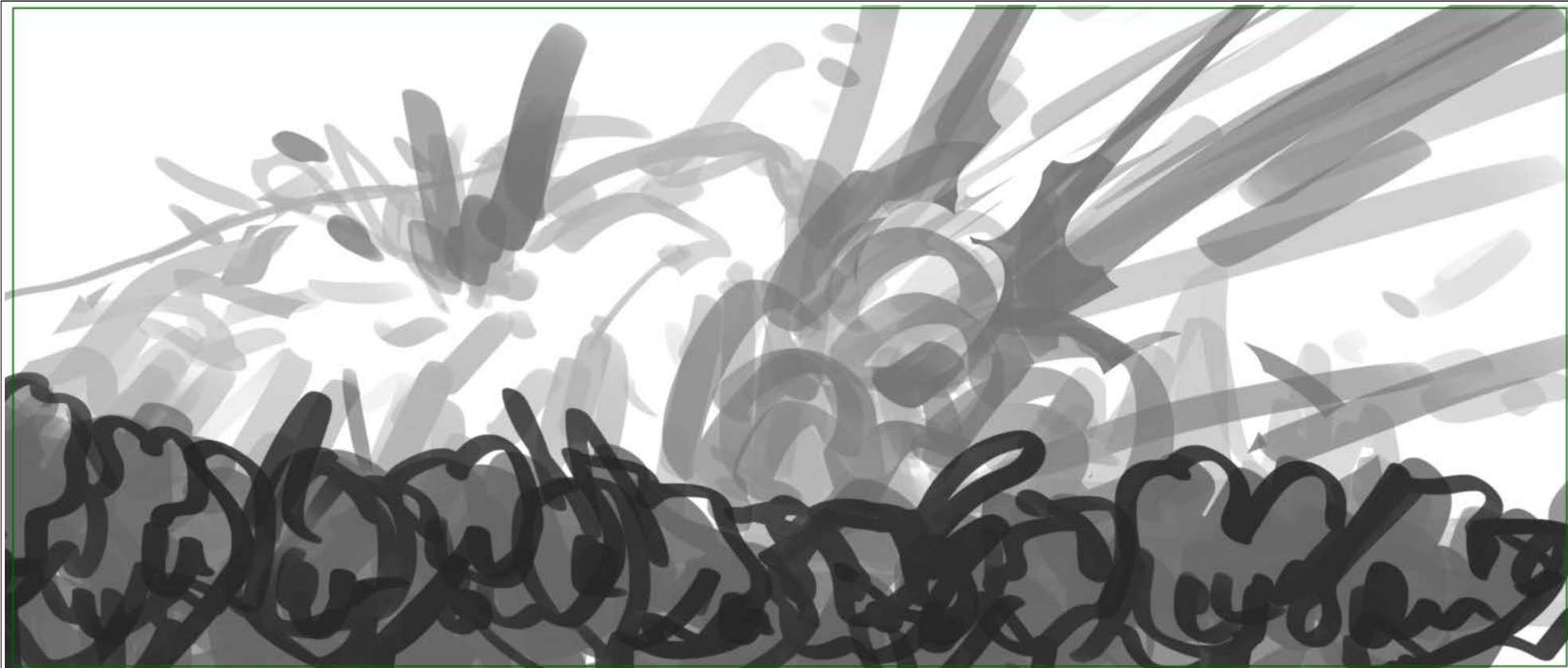

Action Notes

EXT. SHOT OF CAVE COLLAPSING

Scene	Duration	Panel	Duration
660	02:12	001A1	00:04

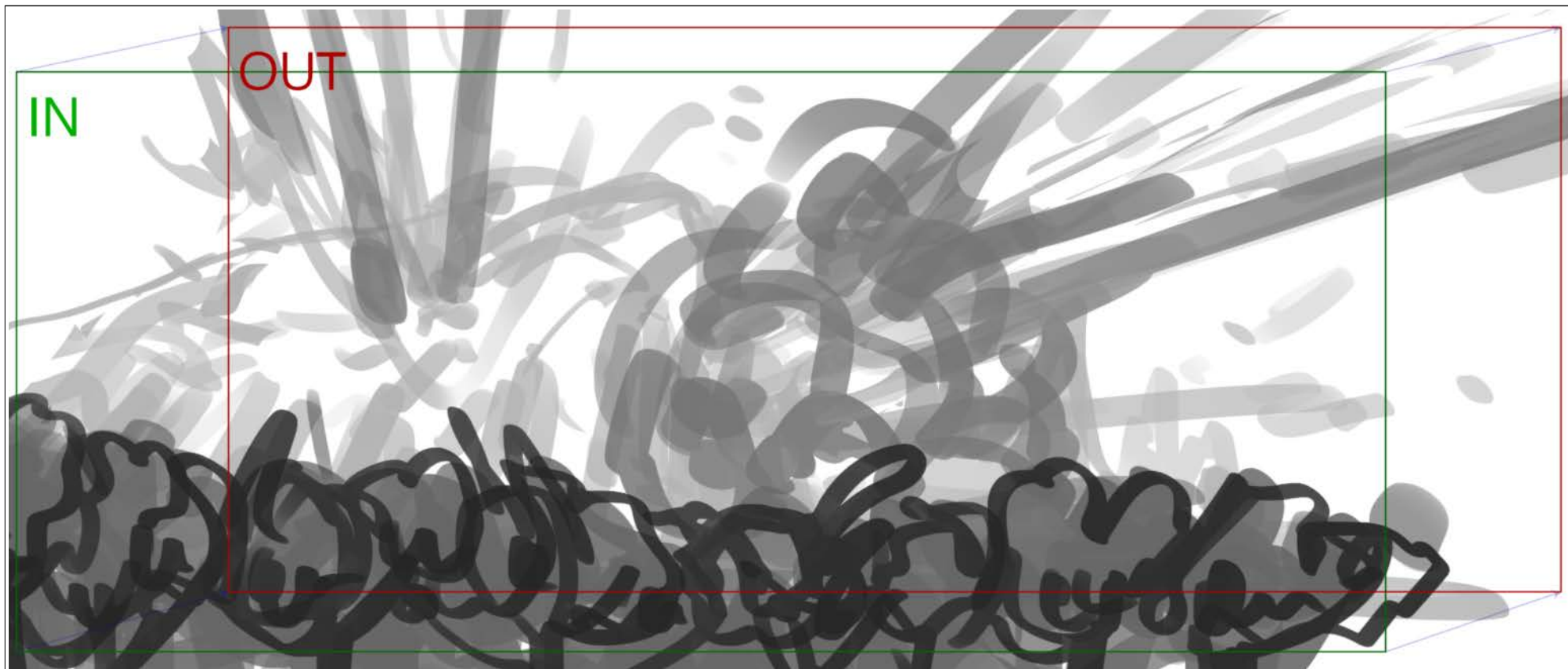

Action Notes

EXT. SHOT OF CAVE COLLAPSING

Scene	Duration	Panel	Duration
660	02:12	001B	00:04

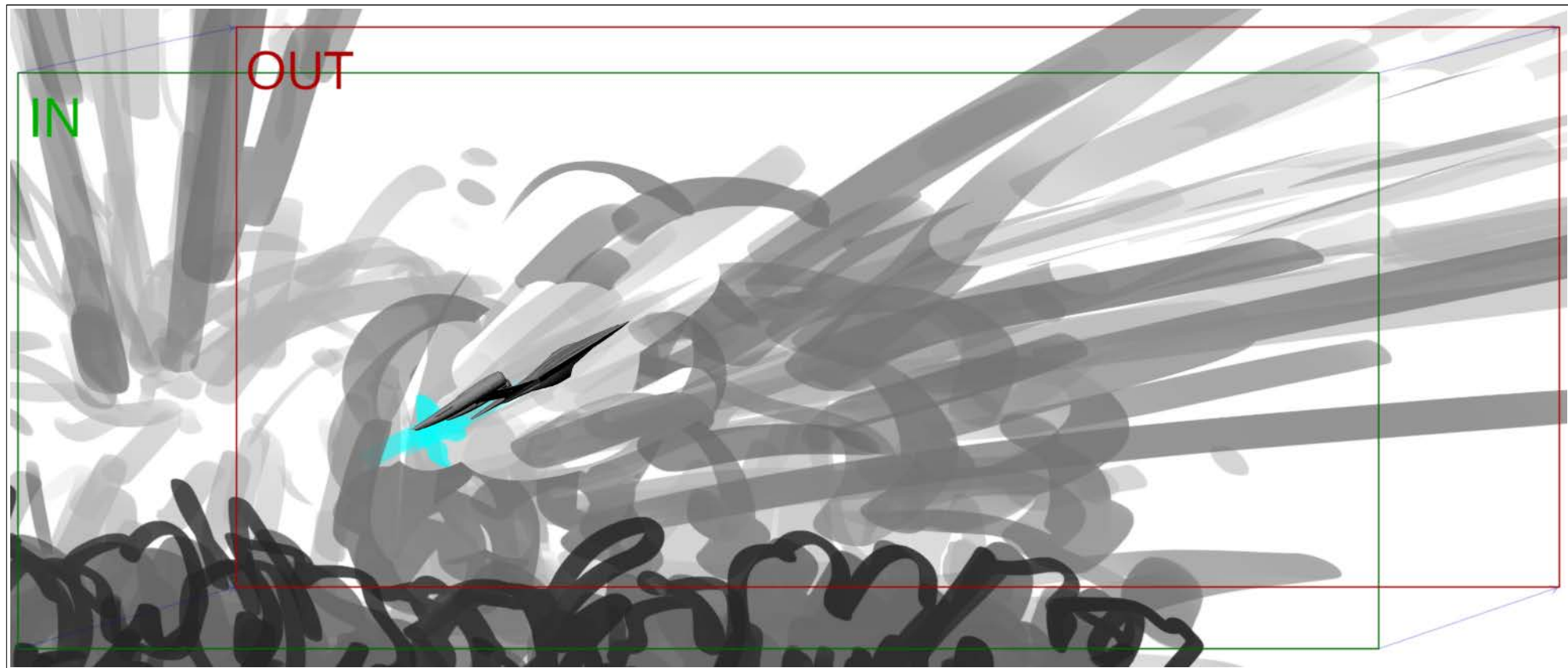

Action Notes

PROTOSTART SHOOTS THROUGH

Scene	Duration	Panel	Duration
660	02:12	001A	00:04

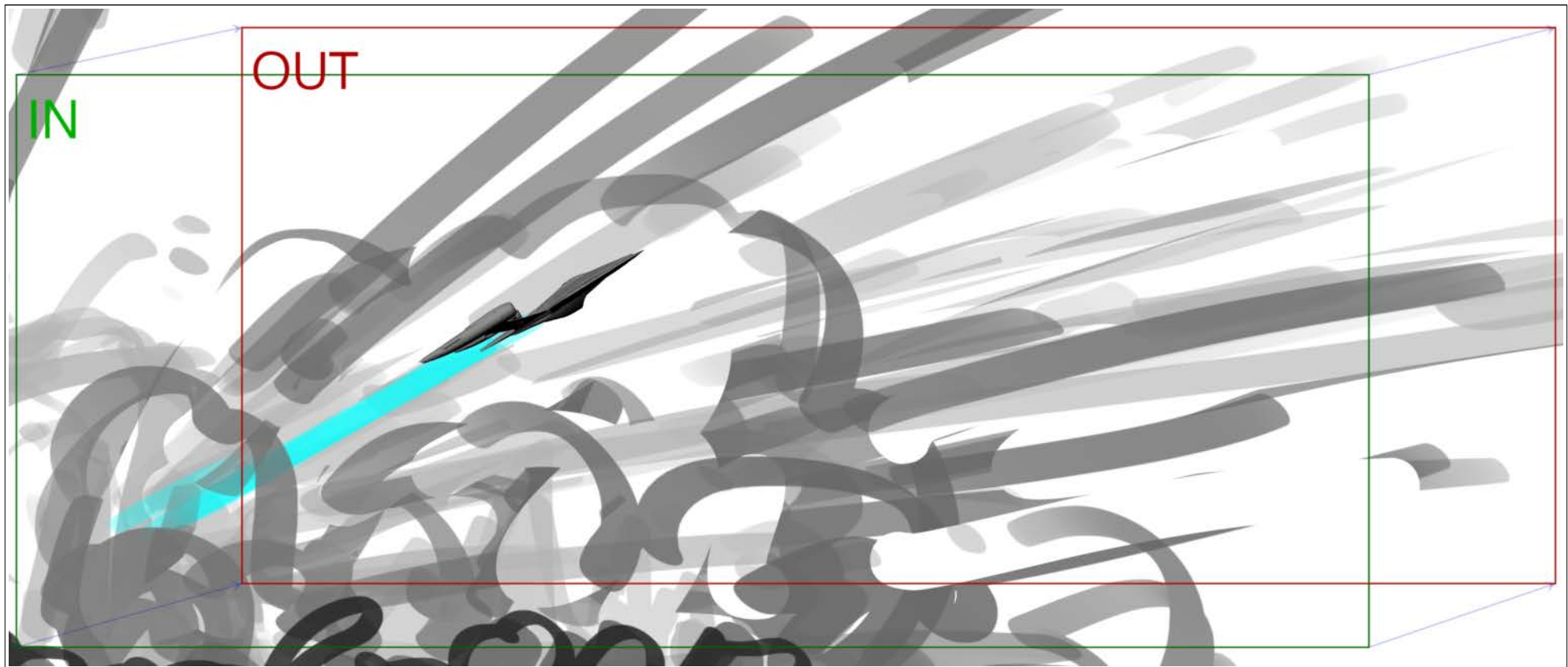

Action Notes

PROTOSTART SHOOTS THROUGH

Scene	660	Duration	02:12	Panel	02A	Duration	00:10
-------	-----	----------	-------	-------	-----	----------	-------

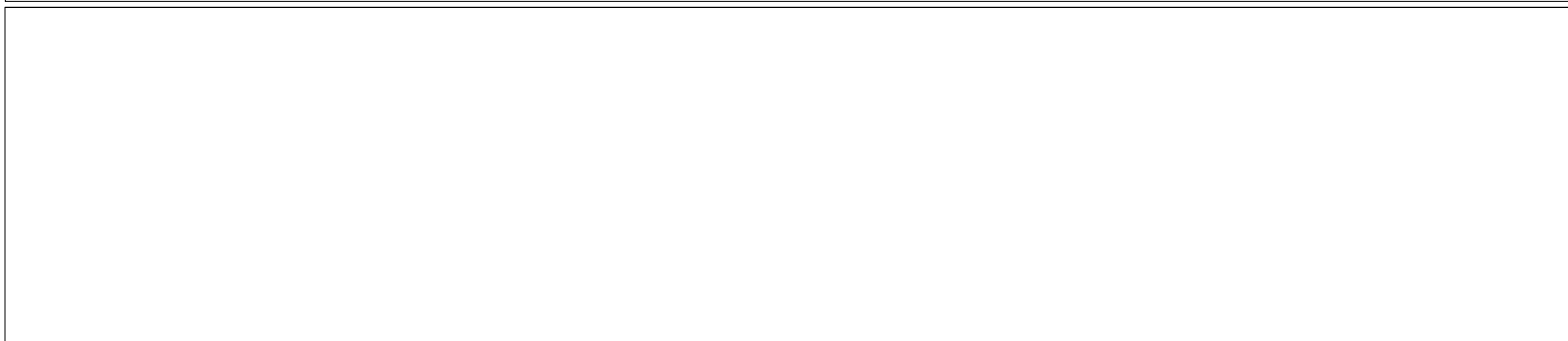
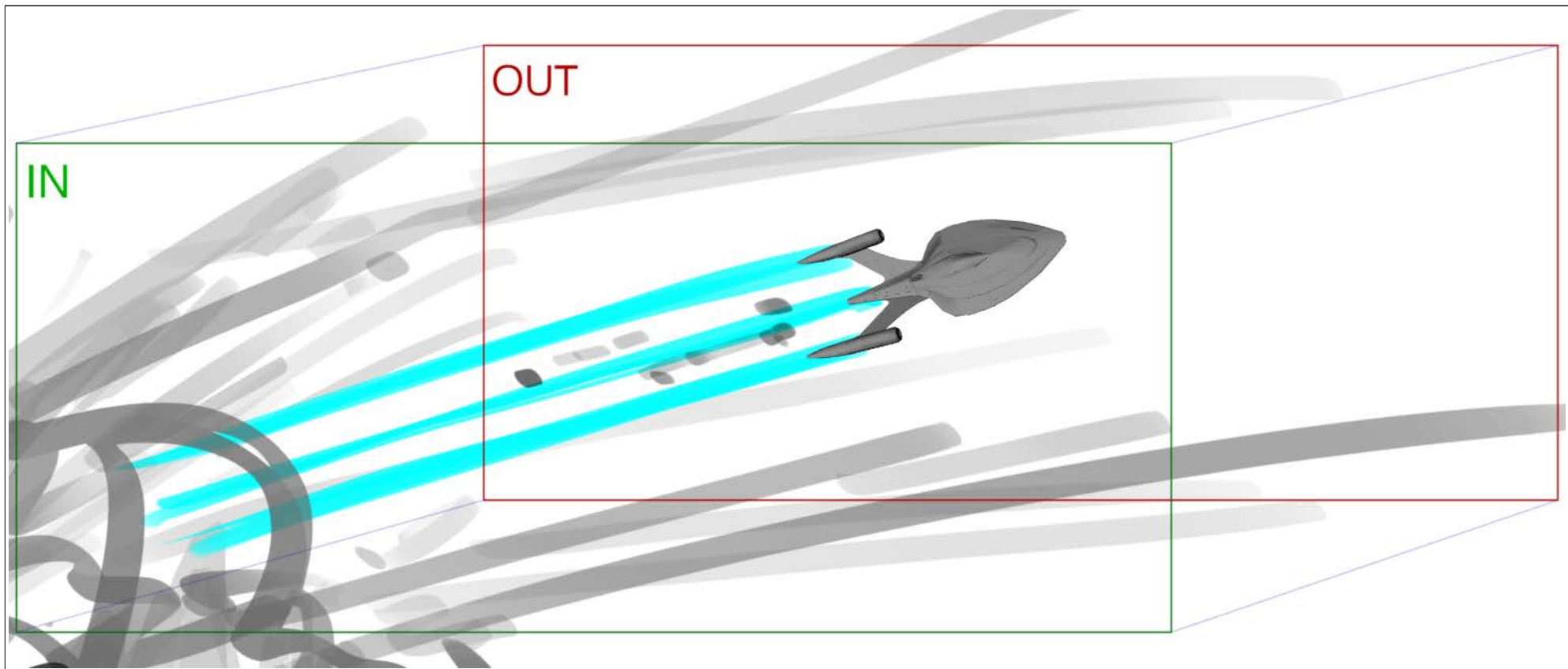

Scene	Duration	Panel	Duration
660	02:12	03A	00:12

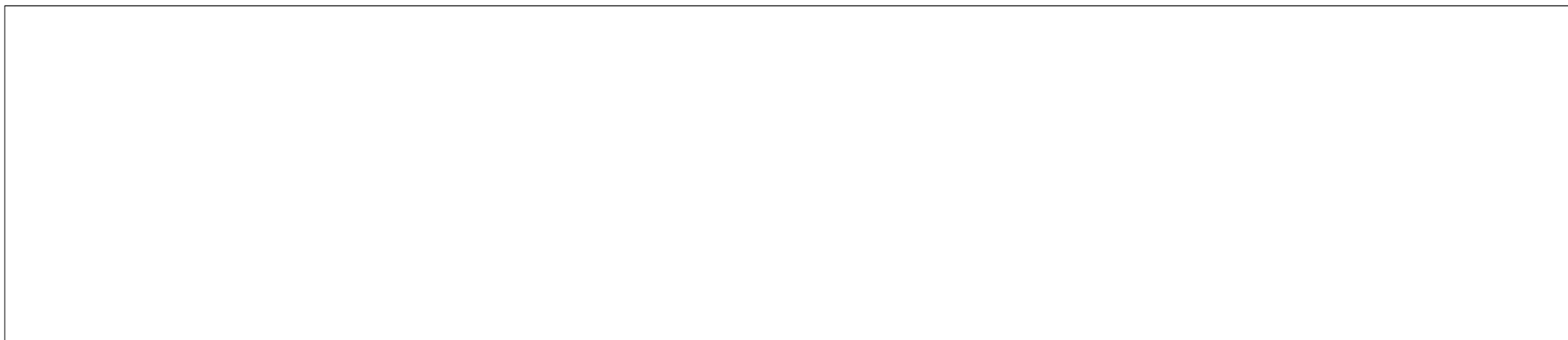
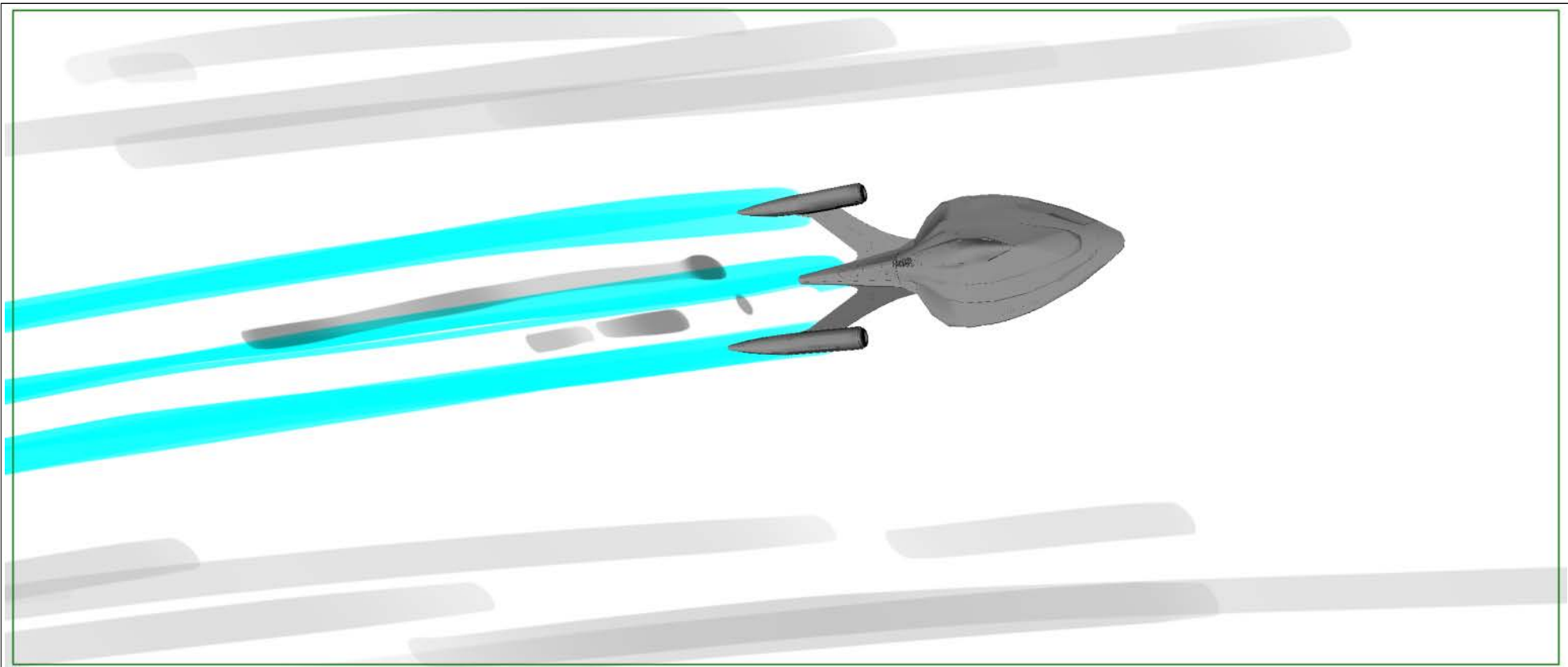

Scene	Duration	Panel	Duration
660	02:12	03B	00:09

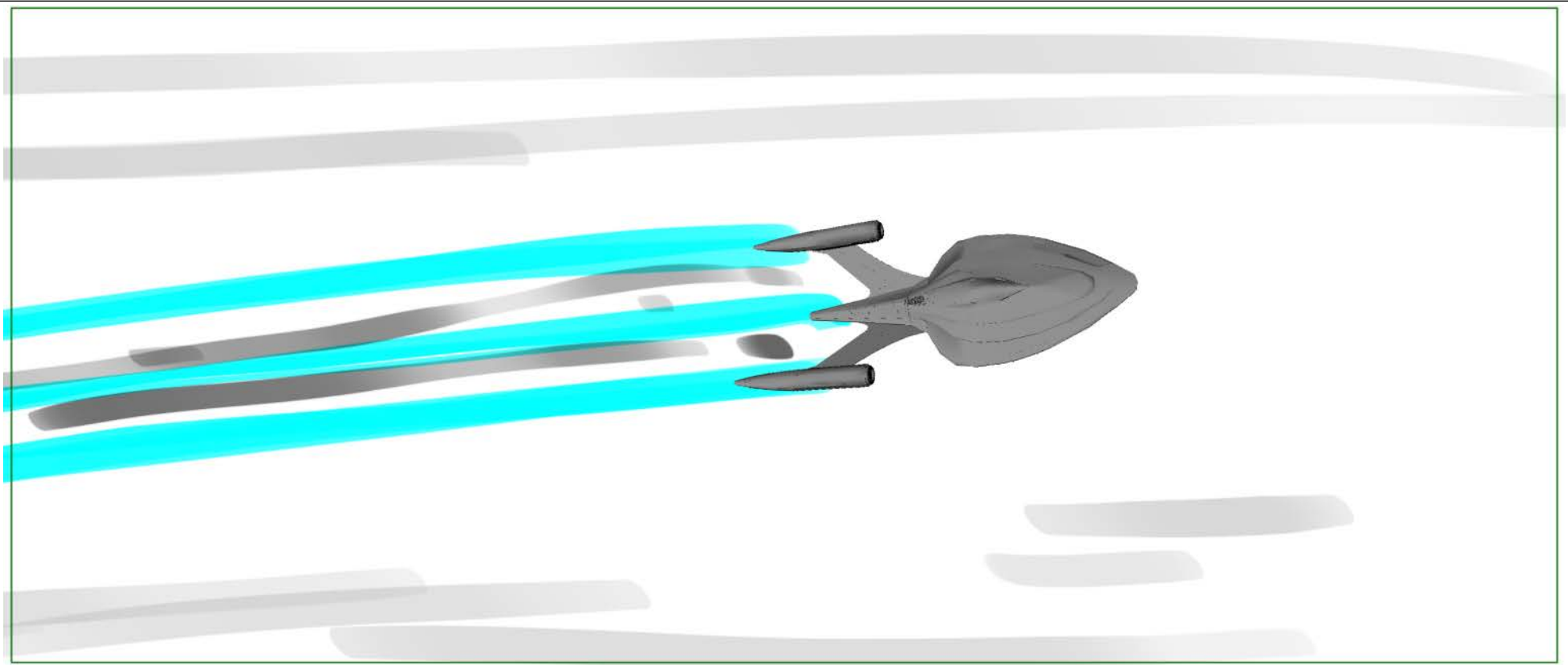

Scene	Duration	Panel	Duration
670	02:09	001	00:07

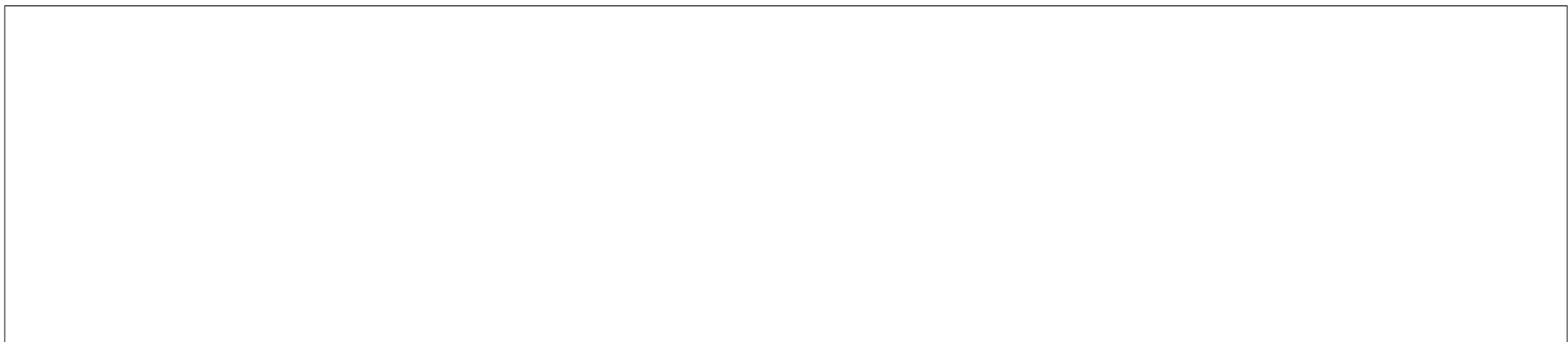
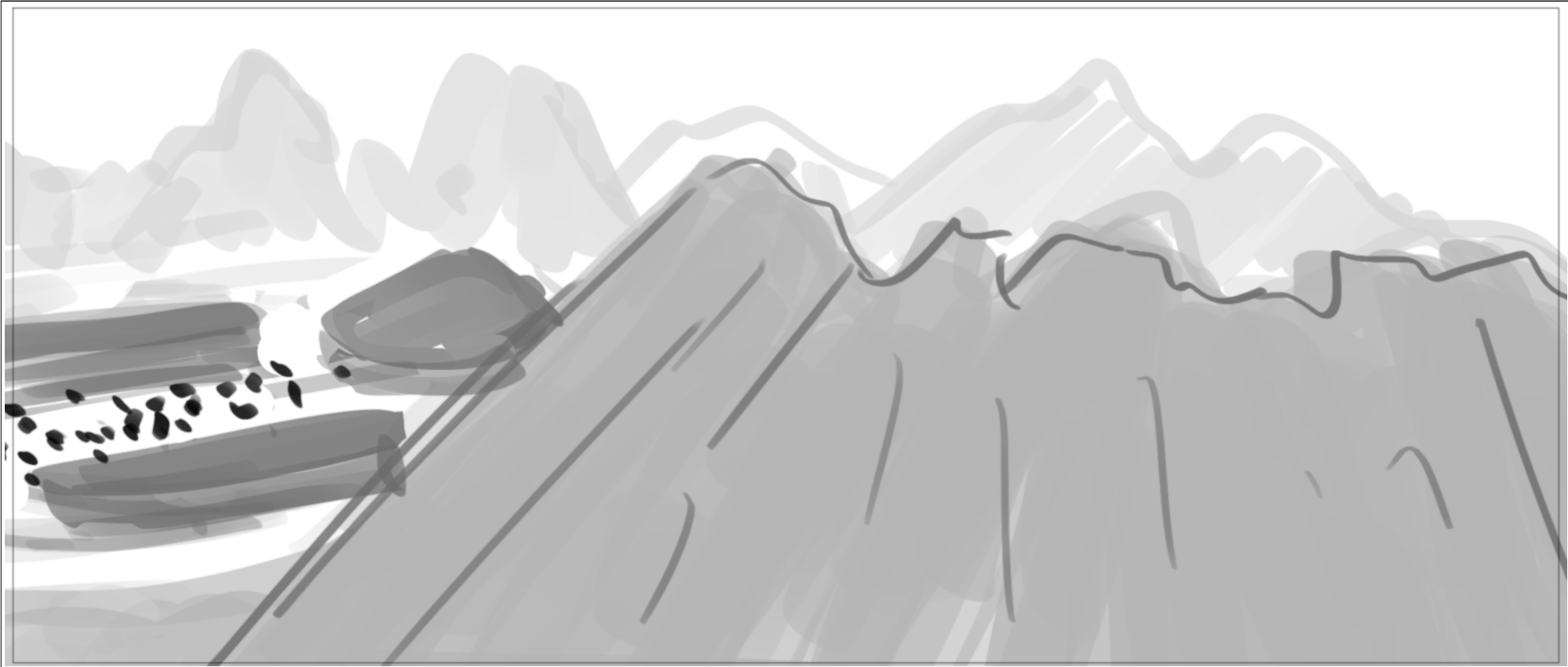

Scene	Duration	Panel	Duration
670	02:09	001A998	00:06

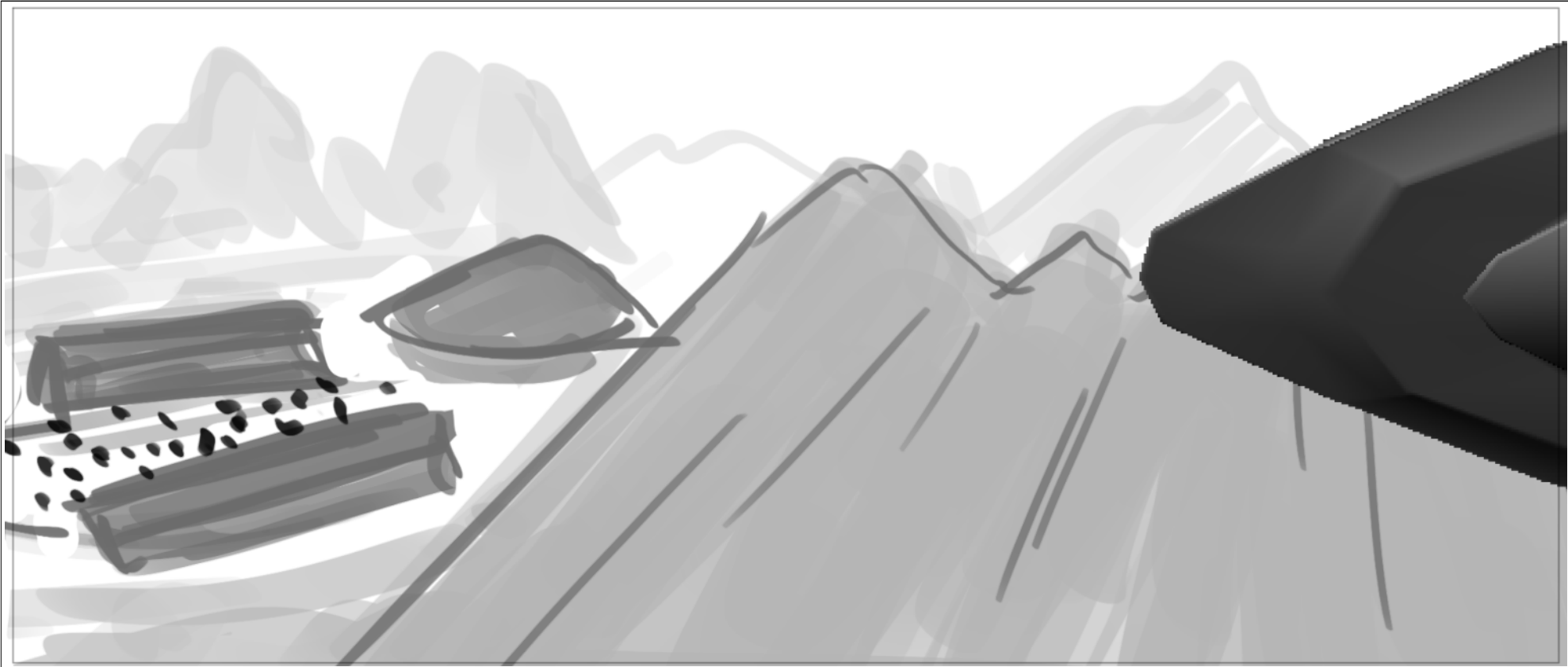

Action Notes

REVERSE SHOT ORBITING VILLAGE

Scene	Duration	Panel	Duration
670	02:09	001A999	00:07

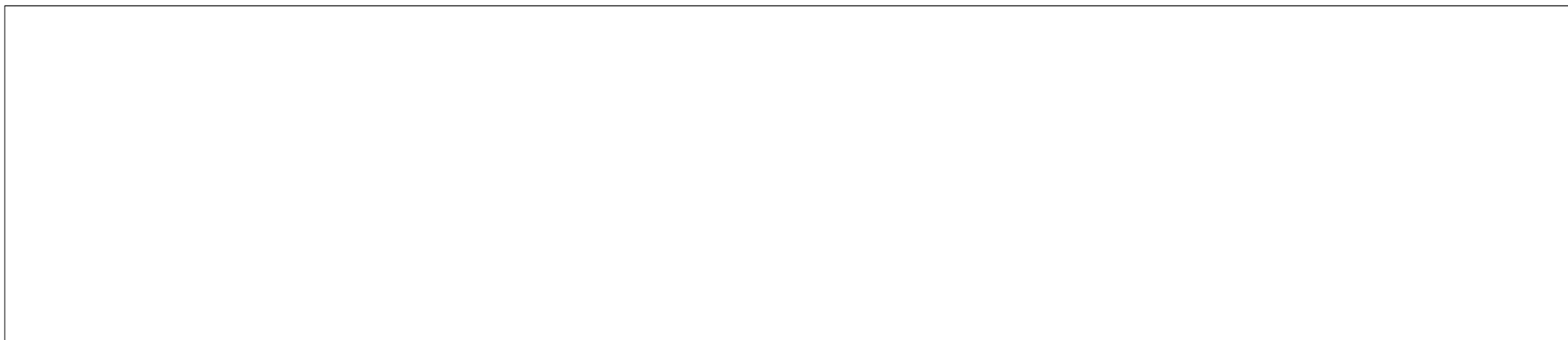
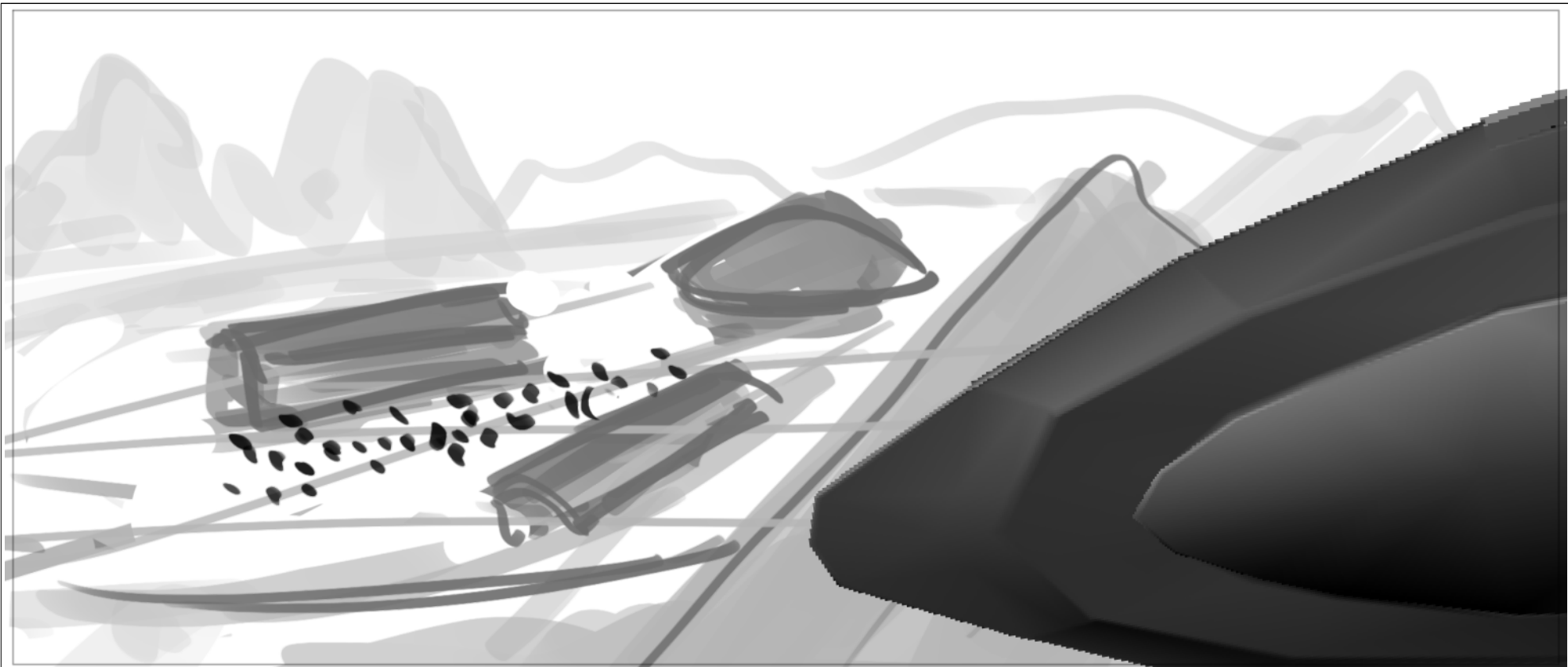

Scene	Duration	Panel	Duration
670	02:09	001B000	00:07

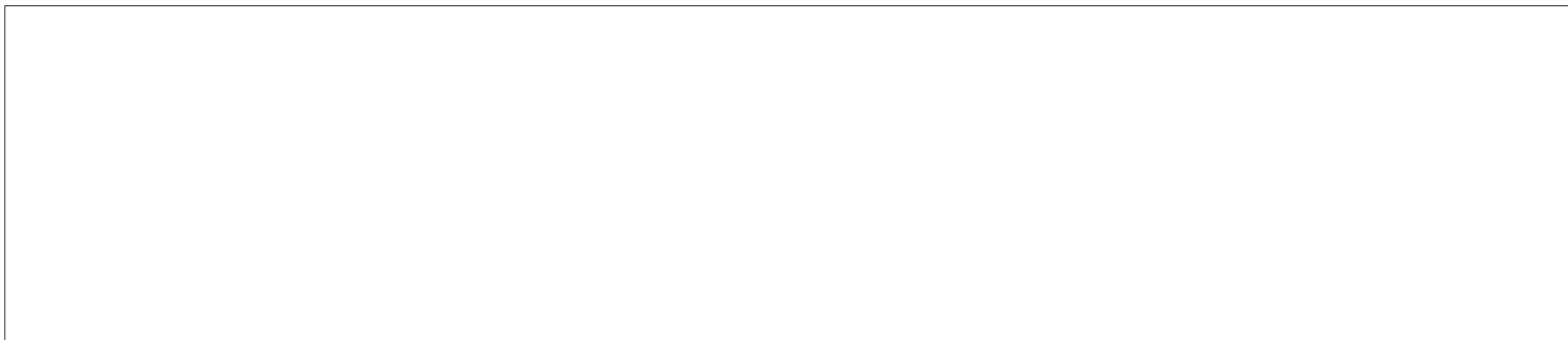
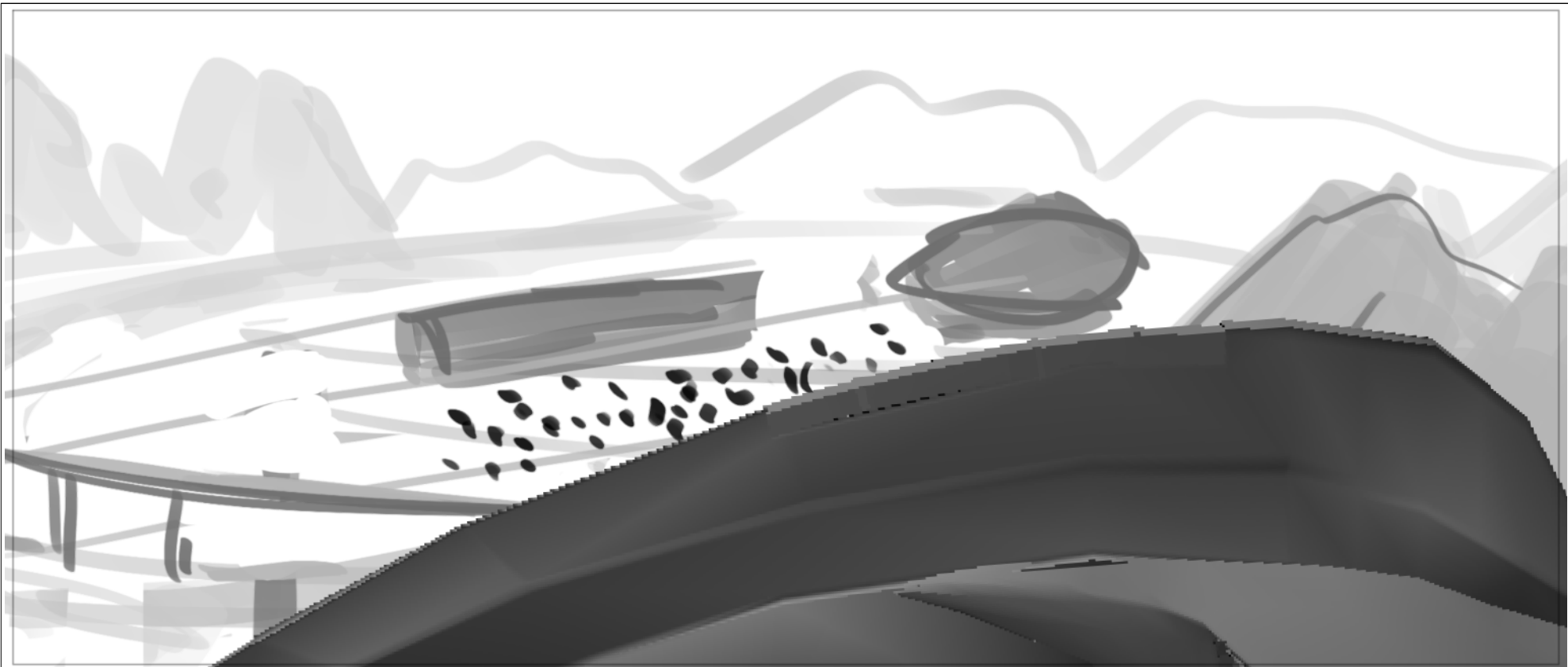

Scene	Duration	Panel	Duration
670	02:09	001A0	00:07

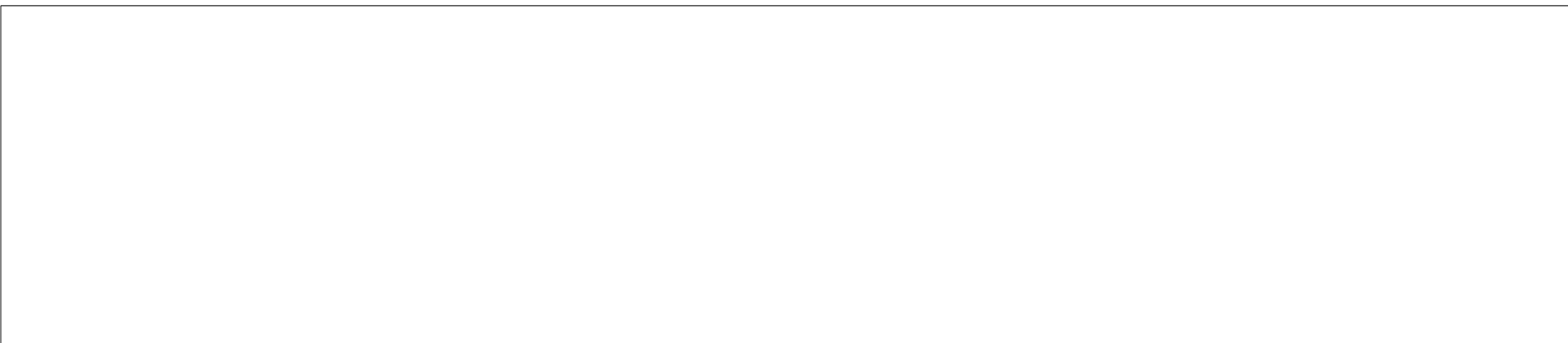
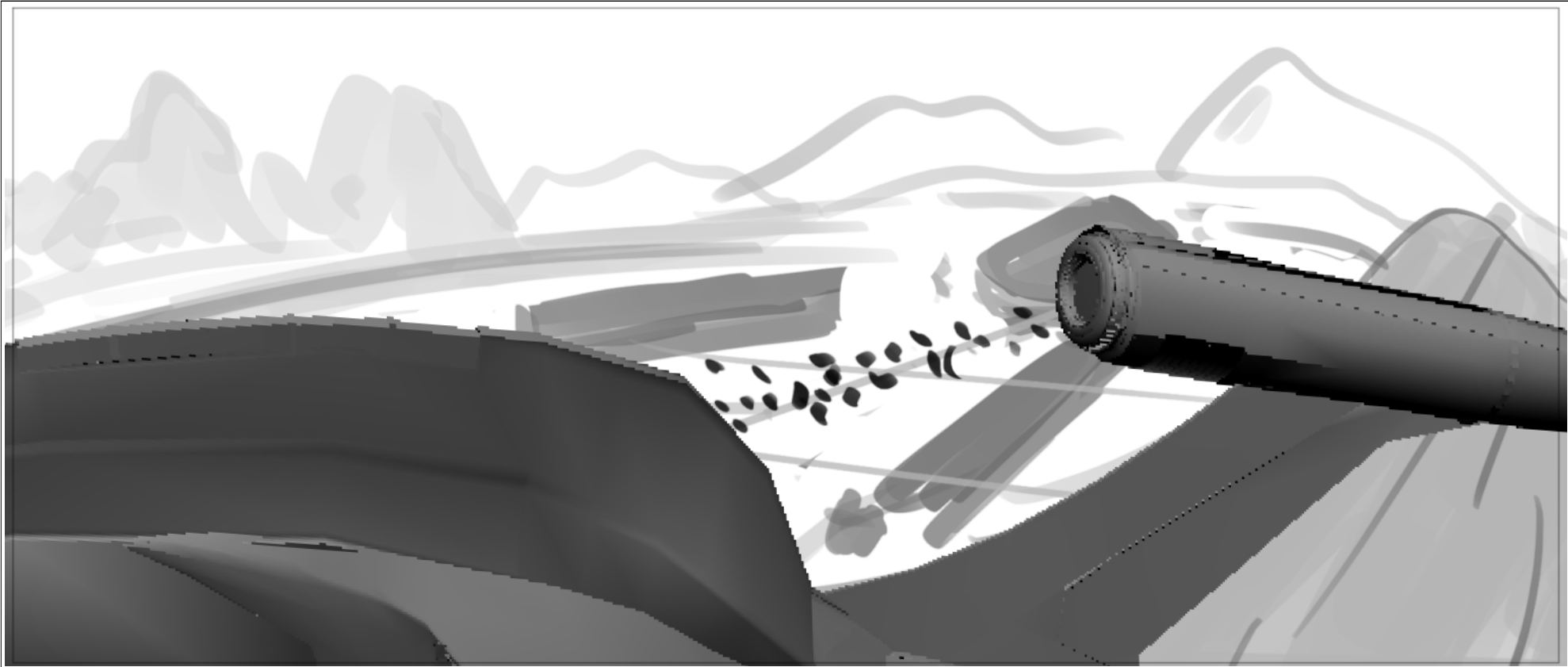

Scene	Duration	Panel	Duration
670	02:09	001A	00:06

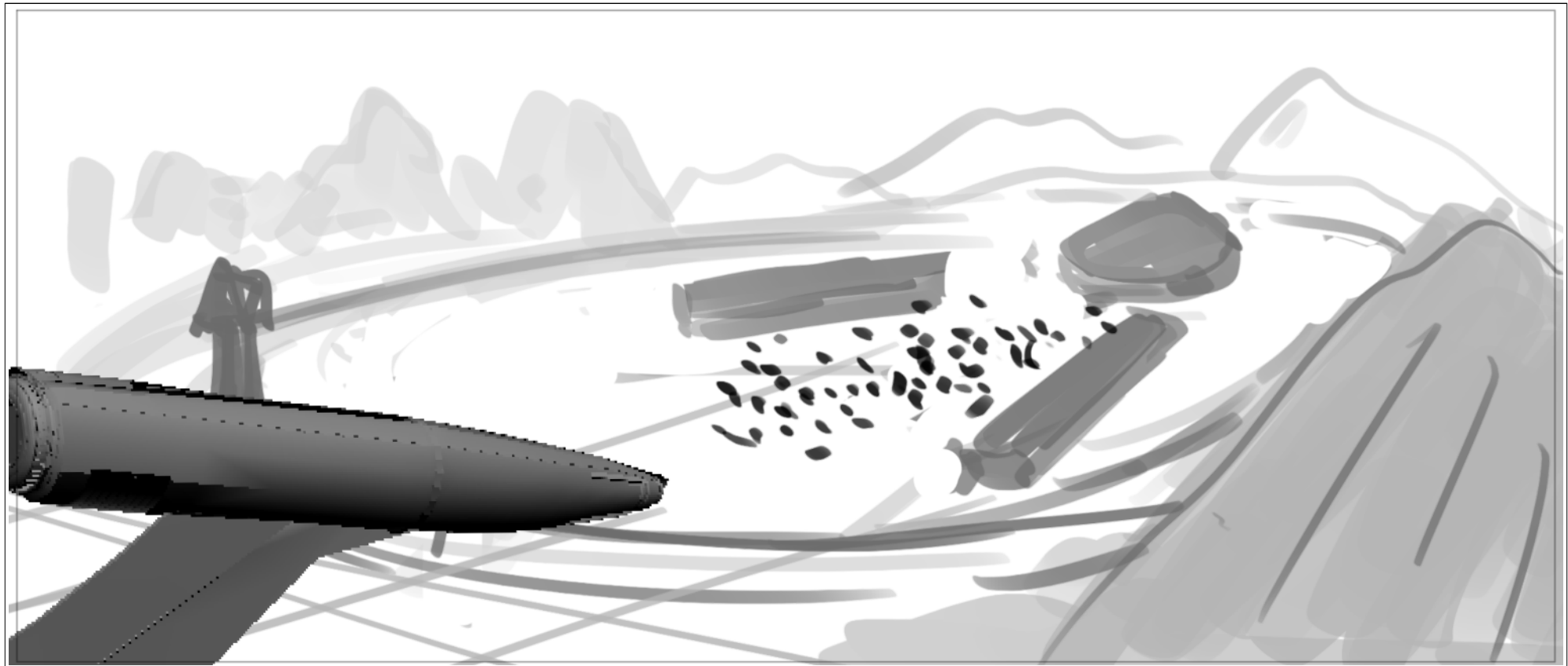

Scene	Duration	Panel	Duration
670	02:09	001B	00:17



Scene	Duration	Panel	Duration
680	01:00	001	01:00



Action Notes

ENDAPRIZIANS REJOICE!

Scene	690	Duration	02:19	Panel	001	Duration	00:21
-------	-----	----------	-------	-------	-----	----------	-------

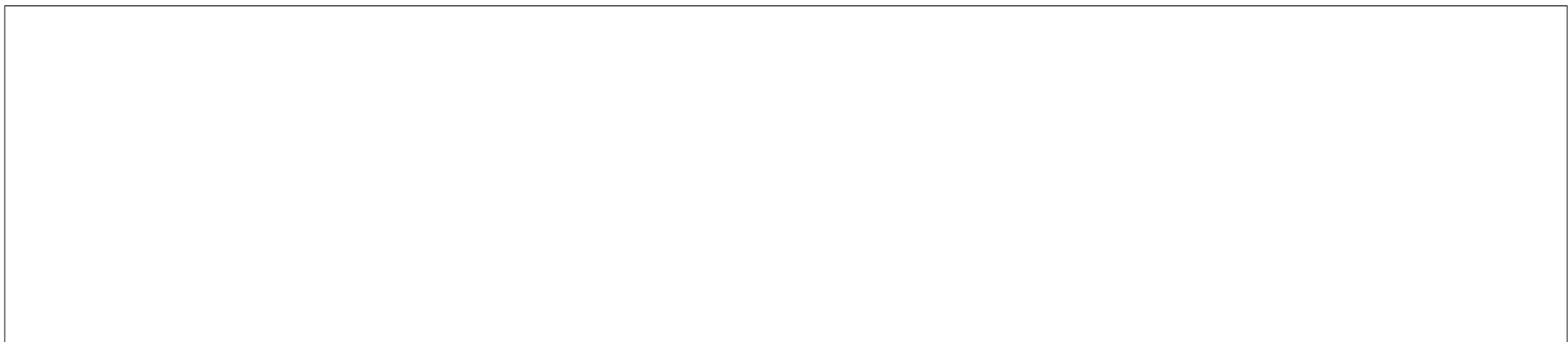
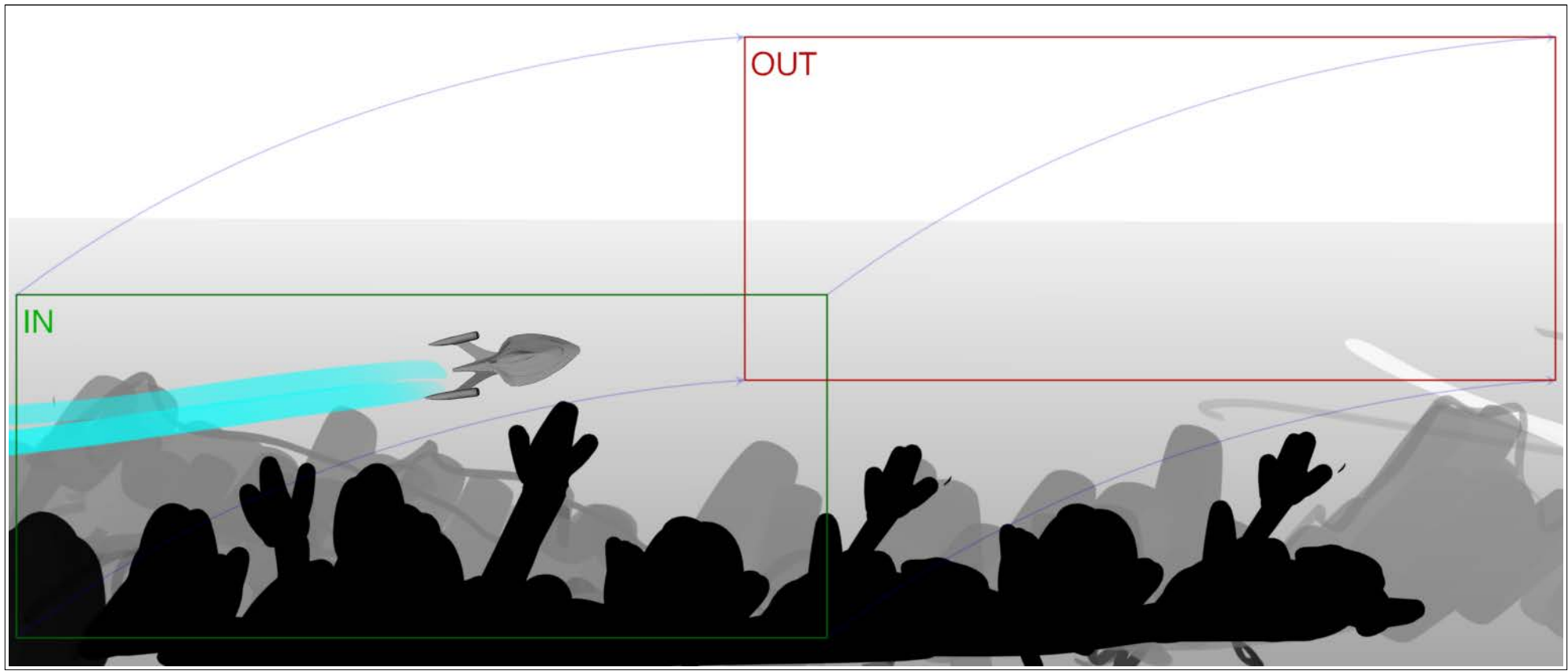

Scene	Duration	Panel	Duration
690	02:19	005A	00:17

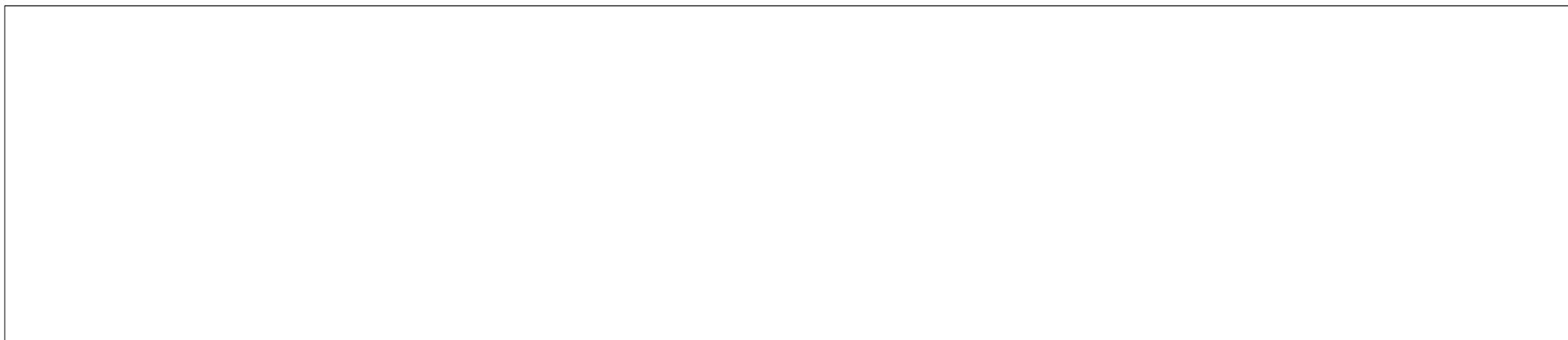
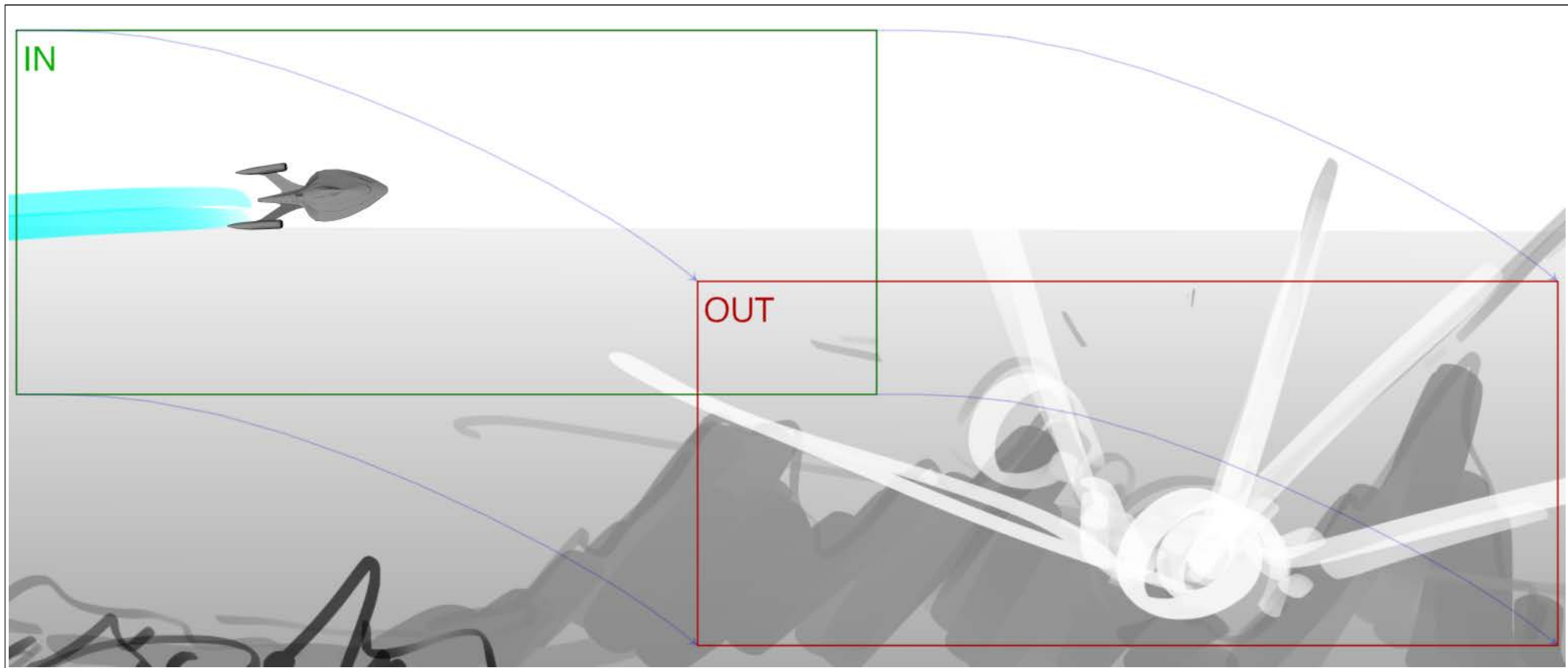

Scene	690	Duration	02:19	Panel	005B	Duration	00:08
-------	-----	----------	-------	-------	------	----------	-------

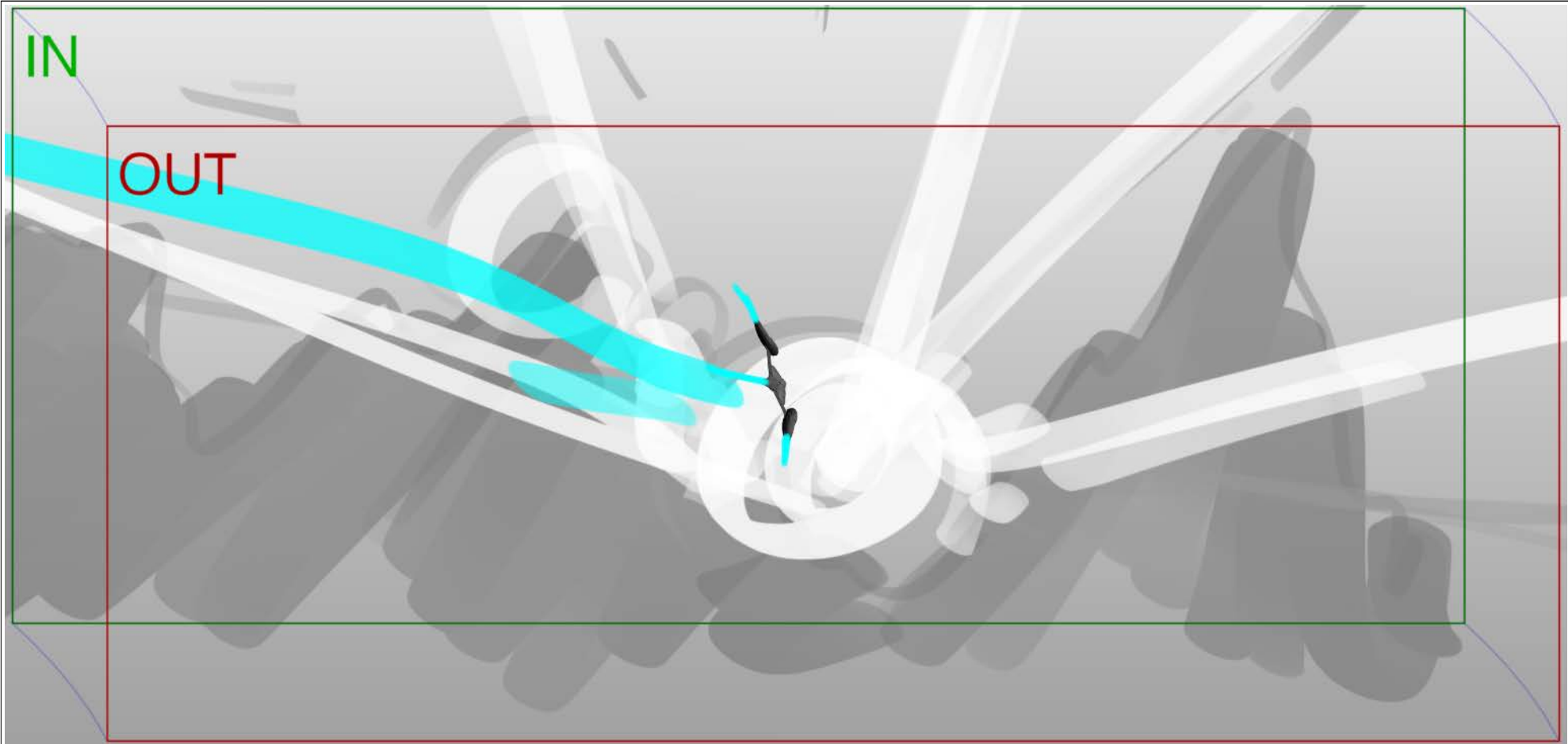

Scene	Duration	Panel	Duration
690	02:19	006	00:21

